

CE
21
Hilti AG FL-9494 Schaan
Hilti-DX-DoP-008
ETA-20/1042
EAD 333037-00-0602
0672
Threaded studs for connection
of materials to structural steel



BUREAU
VERITAS



DNV.COM/AF

Lloyd's Register
TYPE APPROVED



0-1km

Hilti Corrosion handbook / DFTM

A4 316 Equivalent Corrosion Resistance

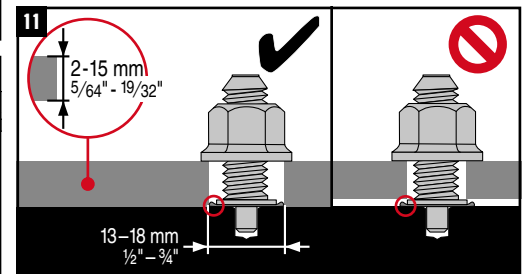
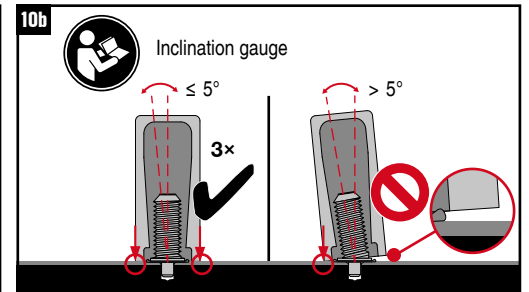
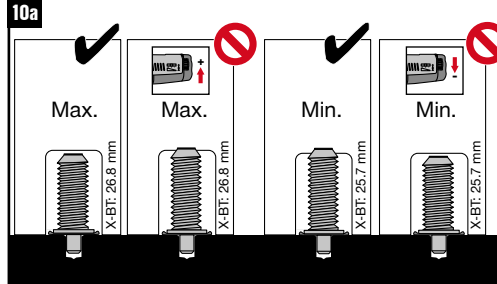
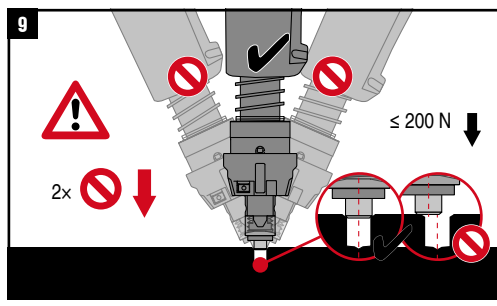
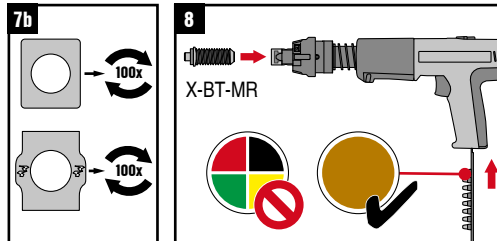
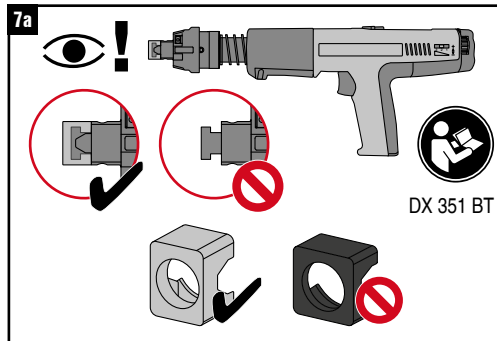
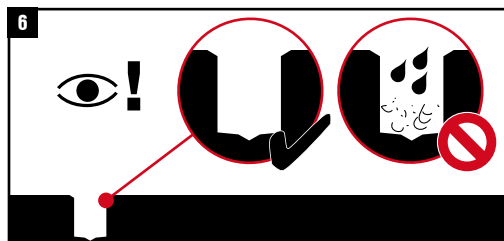
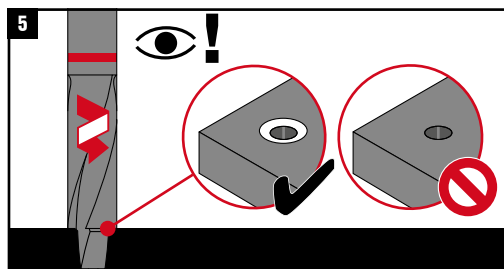
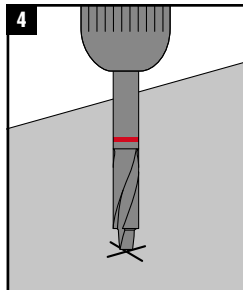
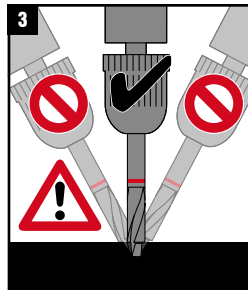
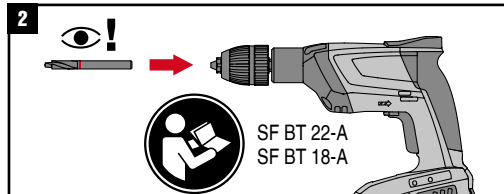
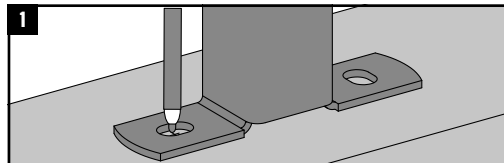

SF 6-A22	1	5
SF 6H-A22	1	5
SF 10W-A22	4	11
SF 8M-A22	4	11
SFC 14-A	2	11
SFC 22-A	2	11

$T_{inst} = 16 - 20 \text{ Nm}$

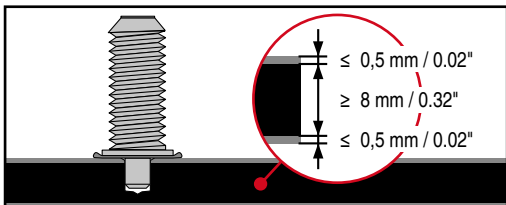
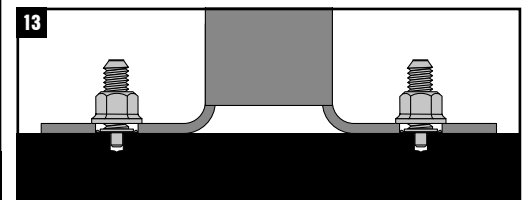

Use with					
X-BT-MR M10/15 SN 8	SF BT 22-A	DX 351-BT	X-BT 1/4"-20Nm/14,8 ft lb	S-NS 15 C 95/3 1/4"	X-IG BT M10
X-BT-MR W10/15 SN 8	SF BT 18-A			S-NS 9/16 C 95/3 3/4"	X-IG BT W10

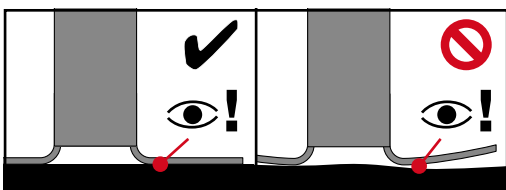

CE
21
Hilti AG FL-9494 Schaan
Hilti-DX-DoP-008
ETA-20/1042
EAD 333037-00-0602
0672
Threaded studs for connection
of materials to structural steel



BUREAU
VERITAS



TYPE-APPROVED PRODUCT
DNV.COM/AF



TYPE
APPROVED



TYPE-APPROVED PRODUCT

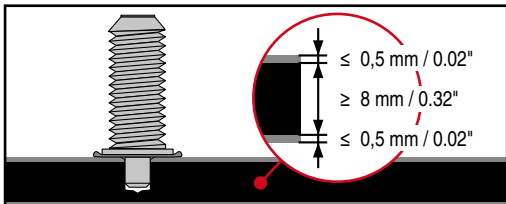
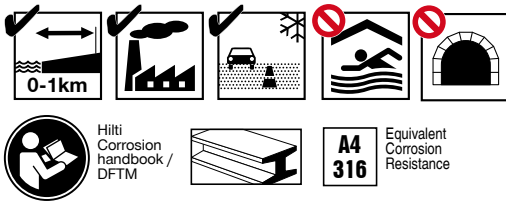

		Use with				
✓		SF BT 22-A SF BT 18-A		X-BT 1/4\"/> 20Nm/ 14,8 ft lb	S-NS 9/16\"/> C 95/3 3/4\"	X-IG BT W10

