

HILTI

TE 30-A36

| | |
|-------------|----|
| Deutsch | de |
| English | en |
| Français | fr |
| Italiano | it |
| Español | es |
| Português | pt |
| Nederlands | nl |
| Ελληνικά | el |
| Magyar | hu |
| Polski | pl |
| Русский | ru |
| Česky | cs |
| Slovenčina | sk |
| Hrvatski | hr |
| Slovenščina | sl |
| Türkçe | tr |
| Українська | uk |

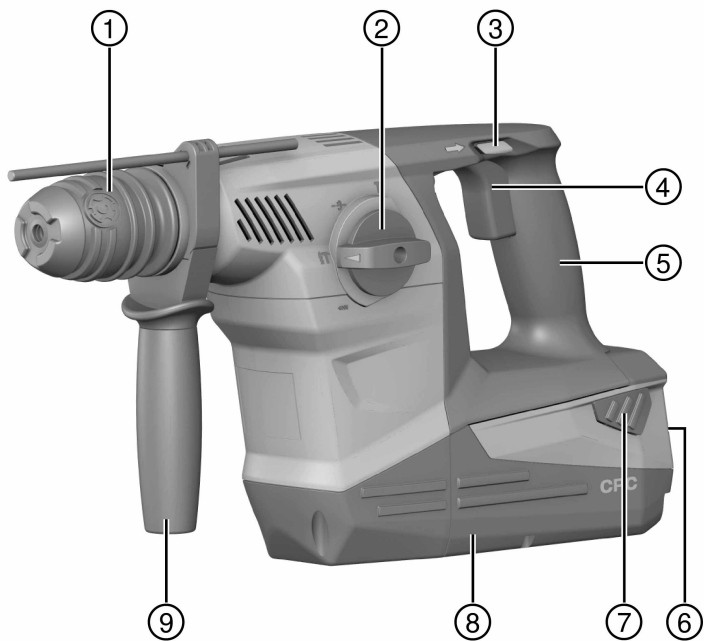



2

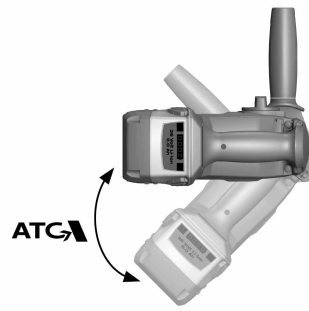

3



4

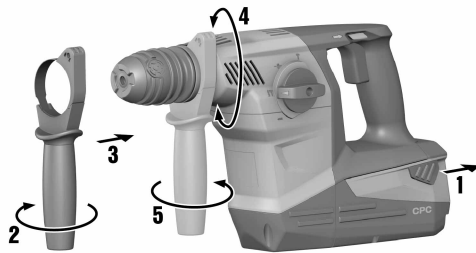

5

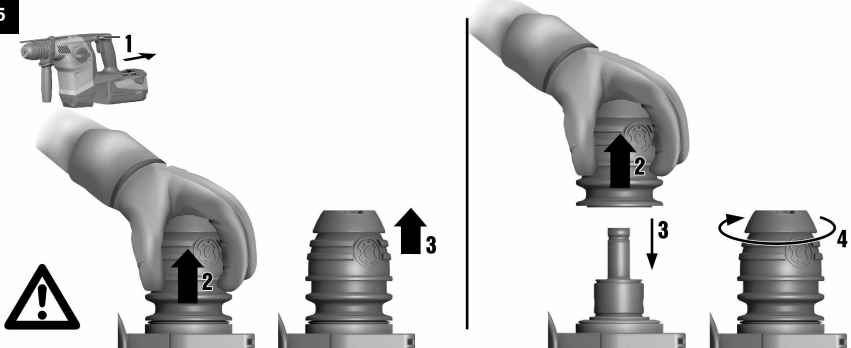

6

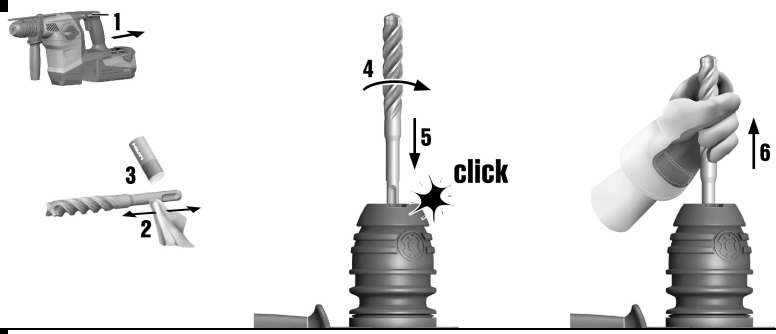

7

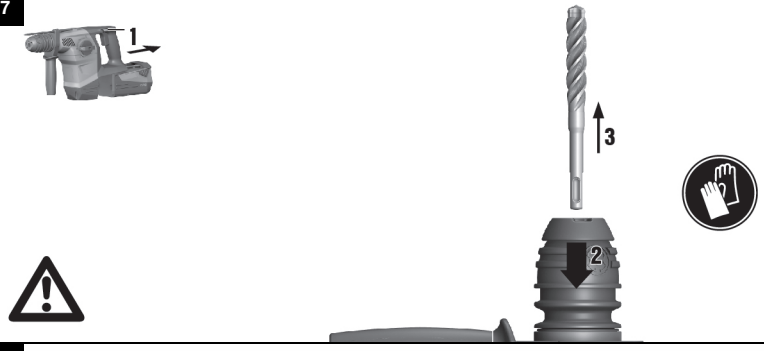

8

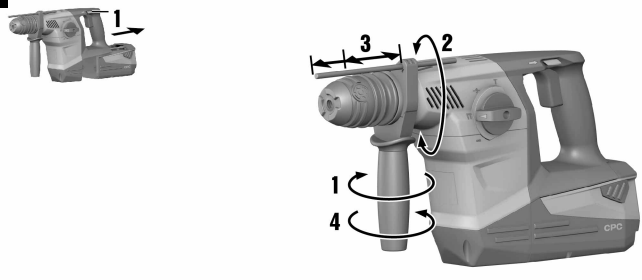

9



10



11

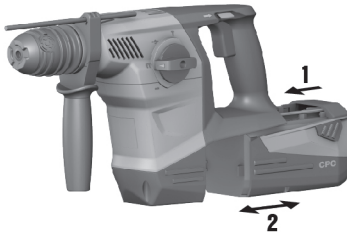

TE 30-A36



| | | |
|----|---|-----|
| de | Original-Bedienungsanleitung | 1 |
| en | Original operating instructions | 11 |
| fr | Mode d'emploi original | 20 |
| it | Istruzioni originali | 30 |
| es | Manual de instrucciones original | 40 |
| pt | Manual de instruções original | 50 |
| nl | Oorspronkelijke handleiding | 60 |
| el | Μετάφραση οδηγιών χρήσης από το πρωτότυπο | 70 |
| hu | Eredeti használati utasítás | 80 |
| pl | Oryginalna instrukcja obsługi | 90 |
| ru | Оригинальное руководство по эксплуатации | 100 |
| cs | Originální návod k obsluze | 111 |
| sk | Pôvodný názov na používanie | 120 |
| hr | Originalne upute za uporabu | 130 |
| sl | Originalna navodila za uporabo | 139 |
| tr | Orijinal kullanım kılavuzu | 148 |
| uk | Оригінальна інструкція з експлуатації | 157 |

1 Information about the documentation

1.1 Explanation of signs used







1.1.1 Warning signs

Warnings alert persons to hazards that occur when handling or using the product. The following signal words are used in combination with a symbol:

| | |
|---|--|
|  | DANGER! Draws attention to imminent danger that will lead to serious personal injury or fatality. |
|  | WARNING! Draws attention to a potentially dangerous situation that could lead to serious personal injury or fatality. |
|  | CAUTION! Draws attention to a potentially dangerous situation that could lead to slight personal injury or damage to the equipment or other property. |

1.1.2 Symbols

The following symbols are used:

| | |
|---|---|
|  | Read the operating instructions before use. |
|  | Instructions for use and other useful information |
|  | Drilling without hammering |
|  | Drilling with hammering action (hammer drilling) |
|  | Forward / reverse |
|  | Chiseling |
|  | Chisel positioning |
| n_0 | Rated speed under no load |
| /min | Revolutions per minute |

1.1.3 Illustrations

The illustrations in these operating instructions are intended to promote a better understanding and may deviate from the actual version of the product.

| | |
|-----------|--|
| 2 | These numbers refer to the corresponding illustrations found at the beginning of these operating instructions. |
| 3 | The numbering in the illustrations reflects the order of the work steps in the illustration and may deviate from the numbering of work steps in the text. |
| 11 | Item reference numbers are used in the overview illustration. In the product overview section, the numbers shown in the legend relate to these item reference numbers. |

1.2 About this documentation

- ▶ Read these operating instructions before the product is used or operated for the first time. This is a prerequisite for safe, trouble-free handling and use of the product.
- ▶ Observe the safety instructions and warnings printed in this documentation and on the tool.
- ▶ Always keep the operating instructions with the tool and make sure that the operating instructions are with the tool when it is given to other persons.

1.3 Product information

Hilti products are designed for professional use and may be operated, serviced and maintained only by trained, authorized personnel. This personnel must be informed of any particular hazards that may be

encountered. The product and its ancillary equipment may present hazards when used incorrectly by untrained personnel or when used not as directed.

The type designation and serial number are printed on the type identification plate.

- ▶ Write down the serial number in the table below. You will be required to state the product details when contacting Hilti Service or your local Hilti organization to enquire about the product.

Product information

| | |
|-------------|-----------|
| Combihammer | TE 30-A36 |
| Generation | 02 |
| Serial no. | |

We reserve the right to make changes. Errors excepted.

2 Safety

2.1 Safety instructions

The safety rules given in the following section contain all general safety rules for electric tools which, in accordance with the applicable standards, require to be listed in the operating instructions. Accordingly, some of the rules listed may not be relevant to this electric tool.

2.1.1 General power tool safety warnings

⚠ WARNING

Read all safety warnings and all instructions. Failure to follow the warnings and instructions may result in electric shock, fire and/or serious injury.

Save all warnings and instructions for future reference.

The term "power tool" in the warnings refers to your mains-operated (corded) power tool or battery-operated (cordless) power tool.

Work area safety

- ▶ **Keep work area clean and well lit.** Cluttered or dark areas invite accidents.
- ▶ **Do not operate power tools in explosive atmospheres, such as in the presence of flammable liquids, gases or dust.** Power tools create sparks which may ignite the dust or fumes.
- ▶ **Keep children and bystanders away while operating a power tool.** Distractions can cause you to lose control.

Electrical safety

- ▶ **Power tool plugs must match the outlet. Never modify the plug in any way. Do not use any adapter plugs with earthed (grounded) power tools.** Unmodified plugs and matching outlets will reduce risk of electric shock.
- ▶ **Avoid body contact with earthed or grounded surfaces, such as pipes, radiators, ranges and refrigerators.** There is an increased risk of electric shock if your body is earthed or grounded.
- ▶ **Do not expose power tools to rain or wet conditions.** Water entering a power tool will increase the risk of electric shock.
- ▶ **Do not abuse the cord. Never use the cord for carrying, pulling or unplugging the power tool. Keep cord away from heat, oil, sharp edges or moving parts.** Damaged or entangled cords increase the risk of electric shock.
- ▶ **When operating a power tool outdoors, use an extension cord suitable for outdoor use.** Use of a cord suitable for outdoor use reduces the risk of electric shock.
- ▶ **If operating a power tool in a damp location is unavoidable, use a residual current device (RCD) protected supply.** Use of an RCD reduces the risk of electric shock.

Personal safety

- ▶ **Stay alert, watch what you are doing and use common sense when operating a power tool. Do not use a power tool while you are tired or under the influence of drugs, alcohol or medication.** A moment of inattention while operating power tools may result in serious personal injury.
- ▶ **Use personal protective equipment. Always wear eye protection.** Protective equipment such as dust mask, non-skid safety shoes, hard hat, or hearing protection used for appropriate conditions will reduce personal injuries.
- ▶ **Prevent unintentional starting. Ensure the switch is in the off-position before connecting to power source and/or battery pack, picking up or carrying the tool.** Carrying power tools with your finger on the switch or energising power tools that have the switch on invites accidents.

- ▶ **Remove any adjusting key or wrench before turning the power tool on.** A wrench or a key left attached to a rotating part of the power tool may result in personal injury.
- ▶ **Do not overreach. Keep proper footing and balance at all times.** This enables better control of the power tool in unexpected situations.
- ▶ **Dress properly. Do not wear loose clothing or jewellery. Keep your hair, clothing and gloves away from moving parts.** Loose clothes, jewellery or long hair can be caught in moving parts.
- ▶ **If devices are provided for the connection of dust extraction and collection facilities, ensure these are connected and properly used.** Use of dust collection can reduce dust-related hazards.

Power tool use and care

- ▶ Do not force the power tool. Use the correct power tool for your application. The correct power tool will do the job better and safer at the rate for which it was designed.
- ▶ **Do not use the power tool if the switch does not turn it on and off.** Any power tool that cannot be controlled with the switch is dangerous and must be repaired.
- ▶ **Disconnect the plug from the power source and/or the battery pack from the power tool before making any adjustments, changing accessories, or storing power tools.** Such preventive safety measures reduce the risk of starting the power tool accidentally.
- ▶ **Store idle power tools out of the reach of children and do not allow persons unfamiliar with the power tool or these instructions to operate the power tool.** Power tools are dangerous in the hands of untrained users.
- ▶ **Maintain power tools. Check for misalignment or binding of moving parts, breakage of parts and any other condition that may affect the power tool's operation. If damaged, have the power tool repaired before use.** Many accidents are caused by poorly maintained power tools.
- ▶ **Keep cutting tools sharp and clean.** Properly maintained cutting tools with sharp cutting edges are less likely to bind and are easier to control.
- ▶ **Use the power tool, accessories and tool bits etc. in accordance with these instructions, taking into account the working conditions and the work to be performed.** Use of the power tool for operations different from those intended could result in a hazardous situation.

Battery tool use and care

- ▶ **Recharge only with the charger specified by the manufacturer.** A charger that is suitable for one type of battery pack may create a risk of fire when used with another battery pack.
- ▶ **Use power tools only with specifically designated battery packs.** Use of any other battery packs may create a risk of injury and fire.
- ▶ **When battery pack is not in use, keep it away from other metal objects, like paper clips, coins, keys, nails, screws or other small metal objects, that can make a connection from one terminal to another.** Shorting the battery terminals together may cause burns or a fire.
- ▶ **Under abusive conditions, liquid may be ejected from the battery; avoid contact. If contact accidentally occurs, flush with water. If liquid contacts eyes, additionally seek medical help.** Liquid ejected from the battery may cause irritation or burns.

Service

- ▶ **Have your power tool serviced by a qualified repair person using only identical replacement parts.** This will ensure that the safety of the power tool is maintained.

2.1.2 Hammer safety warnings

- ▶ **Wear ear protectors.** Exposure to noise can cause hearing loss.
- ▶ **Use auxiliary handles, if supplied with the tool.** Loss of control can cause personal injury.
- ▶ **Hold power tool by insulated gripping surfaces, when performing an operation where the cutting accessory may contact hidden wiring.** Cutting accessory contacting a "live" wire may make exposed metal parts of the power tool "live" and could give the operator an electric shock.

2.1.3 Additional safety instructions

Personal safety

- ▶ **Use the tool only when it is in technically faultless condition.**
- ▶ **Never tamper with or modify the tool in any way.**
- ▶ **Always hold the power tool with both hands on the grips provided. Keep the grips clean and dry.**
- ▶ **Improve the blood circulation in your fingers by relaxing your hands and exercising your fingers during breaks between working.**
- ▶ **Avoid touching rotating parts. Switch the power tool on only after bringing it into position at the workpiece.** Touching rotating parts, especially rotating accessory tools, may lead to injury.

- ▶ **The tool is not intended for use by debilitated persons who have received no special training.**
- ▶ **Keep bystanders, children and visitors away while operating a power tool.**
- ▶ Dust from materials, such as paint containing lead, some wood species, concrete / masonry / stone containing silica, and minerals as well as metal, may be harmful. Contact with or inhalation of the dust may cause allergic reactions and/or respiratory or other diseases to the operator or bystanders. Certain kinds of dust are classified as carcinogenic such as oak and beech dust, especially in conjunction with additives for wood conditioning (chromate, wood preservative). Material containing asbestos may be handled only by specialists. **Use a dust removal system whenever possible. To achieve a high level of dust collection, use a suitable vacuum cleaner. When indicated, wear a respirator appropriate for the type of dust generated. Ensure that the workplace is well ventilated. Follow national requirements for the materials you want to work with.**
- ▶ **Before beginning the work, check the hazard classification of the dust that will be produced. Use an industrial vacuum cleaner with an officially approved protection classification in compliance with locally applicable dust protection regulations.**
- ▶ **Observe the national health and safety requirements.**

Electrical safety

- ▶ **Before beginning work, check the working area for concealed electric cables or gas and water pipes. External metal parts of the power tool may give you an electric shock if you damage an electric cable accidentally.**

Careful handling and use of power tools

- ▶ **Secure the workpiece. A workpiece clamped in a vice or secured by some other clamping device is more secure than when held only by hand.**
- ▶ **Switch the power tool off if the accessory tool sticks and stalls. The power tool may be deflected laterally.**
- ▶ **Wait until the power tool stops completely before you lay it down.**

Careful handling and use of batteries

- ▶ **Observe the special guidelines applicable to the transport, storage and use of lithium-ion batteries.**
- ▶ **Do not expose batteries to high temperatures, the direct heat of the sun, and keep them away from fire.** There is a risk of explosion.
- ▶ **Do not disassemble, squash or incinerate batteries and do not subject them to temperatures over 80°C.** This presents a risk of fire, explosion or injury through contact with caustic substances.
- ▶ **Never continue to use or attempt to charge damaged batteries, e.g. batteries with cracks, broken parts, bent or pushed-in / pulled-out contacts).**
- ▶ **Do not use the battery as a power source for other unspecified power tools or appliances.**
- ▶ If the battery is too hot to touch it may be defective. **In this case, place the power tool in a non-flammable location, well away from flammable materials, where it can be kept under observation and allowed to cool down. Contact Hilti Service after the battery has cooled down.**

3 Description

3.1 Overview of the product 1

- | | |
|----------------------------|---|
| ① Chuck | ⑥ Charge state and fault display (Li-ion battery) |
| ② Function selector switch | ⑦ Release buttons with additional function (charge status display activation) |
| ③ Forward / reverse switch | ⑧ Battery |
| ④ Control switch | ⑨ Side handle with depth gauge |
| ⑤ Grip | |

3.2 Intended use

The product described is a cordless (battery-powered) combihammer. It is designed for drilling in concrete, masonry, wood and metal. The product can also be used for light to medium-duty chiseling on masonry and surface finishing work on concrete.

- ▶ Use only **Hilti** Li-ion batteries from the B 36 series with this product.
- ▶ Use only **Hilti** battery chargers of the C4/36 series for charging these batteries.



Note

Read the operating instructions for the charger for further information about the charging process.

3.3 Active Torque Control

In addition to the mechanical slip clutch, the combihammer is also equipped with ATC (Active Torque Control). This system provides additional drilling safety and convenience as it causes rapid shutdown upon sudden rotation of the combihammer about the drill bit axis. This may occur, for example, when the drill bit sticks due to hitting a rebar or when the drill bit is tilted unintentionally.

Always choose a working position in which the body of the power tool, when running in a forward direction (clockwise), is free to rotate in a counterclockwise direction (as seen by the operator). When running in reverse, the tool reacts to sudden clockwise rotation. If rotational movement is not possible, the ATC system cannot react.

3.4 Lithium-ion battery status display

The charge status of the Li-ion battery and malfunctions of the power tool are indicated by the display on the Li-ion battery. The charge status of the Li-ion battery is displayed after pressing one of the two battery release buttons.

| Status | Meaning |
|--|---|
| 4 LEDs light up. | • Charge state: 75 % to 100 % |
| 3 LEDs light up. | • Charge state: 50 % to 75 % |
| 2 LEDs light up. | • Charge state: 25 % to 50 % |
| 1 LED lights. | • Charge state: 10 % to 25 % |
| 1 LED blinks. | • Charge state: < 10 % |
| 1 LED blinks, the power tool is not ready for use. | • The battery has overheated or is completely discharged. |
| 4 LEDs blink, the power tool is not ready for use. | • The power tool is overloaded or has overheated. |



Note

Battery charge status cannot be displayed while the control switch is pressed and for up to 5 seconds after releasing the control switch.

If the battery display LEDs blink, please observe the instructions given in the Troubleshooting section.

3.5 Items supplied

Combihammer, side handle, depth gauge, operating instructions.



Note

To help ensure safe and reliable operation, use only genuine Hilti spare parts and consumables. Spare parts, consumables and accessories approved by Hilti for use with the product can be found at your local **Hilti Center** or online at: www.hilti.com

4 Technical data

4.1 Combihammer

| | TE 30-A36 |
|--|----------------|
| Rated voltage | 36 V |
| Weight in accordance with EPTA procedure 01/2003 | 5.5 kg |
| Single impact energy in accordance with EPTA procedure 05/2009 | 3.6 J |
| Drilling diameter range in concrete/masonry (hammer drilling) | 6 mm ... 28 mm |
| Drilling diameter range in wood (solid) | 3 mm ... 25 mm |
| Drilling diameter range in metal (solid-head drill bit) | 3 mm ... 13 mm |

4.2 Noise information and vibration values determined in accordance with EN 60745

The sound pressure and vibration values given in these instructions have been measured in accordance with a standardized test and may be used to compare one electric tool with another. They may be used

for a preliminary assessment of exposure. The data given represents the main applications of the electric tool. However, if the electric tool is used for different applications, with different accessory tools, or is poorly maintained, the data may vary. This may significantly increase exposure over the total working period. An accurate estimation of exposure should also take into account the times when the tool is switched off, or when it is running but not actually being used for a job. This may significantly reduce exposure over the total working period. Identify additional safety measures to protect the operator from the effects of noise and/or vibration, for example: maintenance of the electric tool and the accessories, keeping the hands warm, organization of work patterns.







Noise emission values determined in accordance with EN 60745











| | |
|---|-----------|
| Sound (power) level (L_{WA}) | 105 dB(A) |
| Uncertainty for the sound power level (K_{WA}) | 3 dB(A) |
| Emission sound pressure level (L_{pA}) | 94 dB(A) |
| Uncertainty for the sound pressure level (K_{pA}) | 3 dB(A) |

Total vibration (vector sum of three directions), measured in accordance with EN 60745-2-6

| | |
|---|----------------------|
| Hammer drilling in concrete ($a_{h, HD}$) | 11 m/s ² |
| Chiseling ($a_{h, Chisq}$) | 9 m/s ² |
| Uncertainty (K) | 1.5 m/s ² |

5 Operation

| | |
|--|----------|
| Removing the battery | 3 |
| Fitting the side handle  CAUTION Risk of injury! Loss of control over the combihammer. <ul style="list-style-type: none"> ▶ Check that the side handle is fitted correctly and tightened securely. Check that the clamping band is engaged in the groove provided on the tool.  CAUTION Risk of injury! The depth gauge may hinder the operator if fitted but not used. <ul style="list-style-type: none"> ▶ Remove the depth gauge from the tool. | 4 |
| Fitting / removing the chuck  CAUTION Risk of injury! The depth gauge may hinder the operator if fitted but not used. <ul style="list-style-type: none"> ▶ Remove the depth gauge from the tool. | 5 |
| Fitting the chisel  Note The use of unsuitable grease may cause damage to the tool. Use only the recommended grease supplied by Hilti.  Note After fitting the drill bit, grip it and pull it in order to check that it is securely engaged. | 6 |
| Removing the accessory tool  DANGER Risk of fire! Risk of contact between the hot accessory tool and highly inflammable materials. <ul style="list-style-type: none"> ▶ Do not lay the hot accessory tool down on highly inflammable materials.  WARNING Risk of injury! The tool becomes hot as a result of use. <ul style="list-style-type: none"> ▶ Wear protective gloves when changing the tool. | 7 |
| Fitting and adjusting the depth gauge | 8 |

| | |
|--|-----------|
| <p>Forward / reverse</p> <p> CAUTION Risk of damage Actuation while the tool is running may result in damage to the gearing.</p> <ul style="list-style-type: none"> ▶ Do not operate the forward / reverse switch while the motor is running. | 9 |
| <p>Inserting the battery</p> <p> WARNING Risk of injury! Inadvertent starting of the combihammer.</p> <ul style="list-style-type: none"> ▶ Before fitting the battery, check that the combihammer is switched off and that the forward / reverse switch is in the middle position (i.e. safety lock engaged). <p> WARNING Electrical hazard! Risk of short circuiting.</p> <ul style="list-style-type: none"> ▶ Before inserting the battery, check to ensure that the battery terminals and the contacts on the combihammer are free from foreign objects. <p> WARNING Risk of injury! Hazard presented by a falling battery.</p> <ul style="list-style-type: none"> ▶ A falling battery may present a risk of injury to yourself and others. Check that the battery is securely seated in the combihammer. | 11 |
| <p>Drilling without hammering </p> | 10 |
| <p>Hammer drilling </p> | 10 |
| <p>Chiseling </p> | 10 |
| <p>Chisel positioning </p> <p> CAUTION Risk of injury! Loss of control over the chisel direction.</p> <ul style="list-style-type: none"> ▶ Do not operate the tool when the selector switch is set to “Chisel positioning”. Turn the function selector switch until it engages in the “Chiseling” position. <p> Note The chisel can be adjusted to 12 different positions (in 30° increments). This ensures that flat chisels and shaped chisels can always be set to the optimum working position.</p> | 10 |

6 Care, maintenance, transport and storage

6.1 Care of the product

-  **WARNING**
Danger of electric shock! Improper repairs to electrical components may lead to serious injuries including burns.
- ▶ Repairs to the electrical section of the tool or appliance may be carried out only by trained electrical specialists.

- ▶ **Keep the product, especially its grip surfaces, clean and free from oil and grease. Do not use cleaning agents containing silicone.**
- ▶ Never operate the product when the air vents are blocked. Clean the air vents carefully using a dry brush. Do not allow foreign objects to enter the interior of the product.
- ▶ Clean the outside of the electric tool at regular intervals with a slightly damp cloth. Do not use a spray, steam pressure cleaning equipment or running water for cleaning.

6.2 Care of the lithium-ion batteries



Note

Battery discharge is stopped automatically before the battery cells suffer damage.

A conditioning charge of the battery is not necessary.

Interruption of the charging operation has no negative effect on battery life.

Charging can be started at any time with no negative effect on battery life.

If the battery no longer reaches full charge, it may have lost capacity due to aging or overstressing. It is possible to continue working with a battery in this condition but it should be replaced in good time.

- ▶ Charge batteries fully before using them for the first time.
- ▶ Do not allow moisture to enter the interior.

6.3 Transport and storage of batteries



WARNING

Risk of fire! Risk of short circuiting.

- ▶ To avoid short circuits and associated heat generation, lithium-ion batteries should never be stored or transported in loose, bulk form and without protective measures.
-
- ▶ Pull the battery out of its locked position and into the first engagement position.
 - ▶ Observe the nationally and internationally applicable transport regulations when shipping batteries by road, rail, sea or air.



Note

Ideally, the battery should be stored in a fully-charged state in a dry place that is as cool as possible. Storing the battery in places subject to high ambient temperatures (e.g. by a window) has an adverse effect on battery life and increases the rate of self-discharge.

7 Disposal



WARNING

Risk of injury. Hazards presented by improper disposal.

- ▶ Improper disposal of the equipment may have the following consequences: The burning of plastic components generates toxic fumes which may present a health hazard. Batteries may explode if damaged or exposed to very high temperatures, causing poisoning, burns, acid burns or environmental pollution. Careless disposal may permit unauthorized and improper use of the equipment. This may result in serious personal injury, injury to third parties and pollution of the environment.
- ▶ Dispose of defective batteries right away. Keep them out of reach of children. Do not disassemble or incinerate the batteries.
- ▶ Batteries that have reached the end of their life must be disposed of in accordance with national regulations or returned to **Hilti**.

 Most of the materials from which **Hilti** tools and appliances are manufactured can be recycled. The materials must be correctly separated before they can be recycled. In many countries, your old tools, machines or appliances can be returned to **Hilti** for recycling. Ask **Hilti** Service or your Hilti representative for further information.

In accordance with the European Directive on waste electrical and electronic equipment and its implementation in conformance with national law, electric tools or appliances that have reached the end of their life must be collected separately and returned to an environmentally compatible recycling facility.



- ▶ Disposal of electric tools or appliances together with household waste is not permissible.

8 Manufacturer's warranty

- ▶ Please contact your local **Hilti** representative if you have questions about the warranty conditions.

9 EC declaration of conformity

Manufacturer

Hilti Aktiengesellschaft
Feldkircherstrasse 100
9494 Schaan

Liechtenstein

We declare, on our sole responsibility, that this product complies with the directives and standards listed below.

Designation Cordless combihammer

Type designation TE 30-A36

Generation 02

Year of design 2012

Applicable directives:

- 2004/108/EC (up to April 19, 2016)
- 2014/30/EU (as of April 20, 2016)
- 2006/42/EC
- 2011/65/EU
- 2006/66/EC

Applicable standards:

- EN 60745-1, EN 60745-2-6
- EN ISO 12100

Technical documentation filed at:

- Hilti Entwicklungsgesellschaft mbH
Zulassung Elektrowerkzeuge
Hiltistraße 6
86916 Kaufering
Germany

Schaan, 5/2015



Paolo Luccini
(Head of BA Quality & Process Management /
Business Area Electric Tools & Accessories)



Tassilo Deinzer
(Executive Vice President / Business Unit Power
Tools & Accessories)



Hilti Corporation

LI-9494 Schaan

Tel.: +423/234 21 11

Fax: +423/234 29 65

www.hilti.com



2033711