

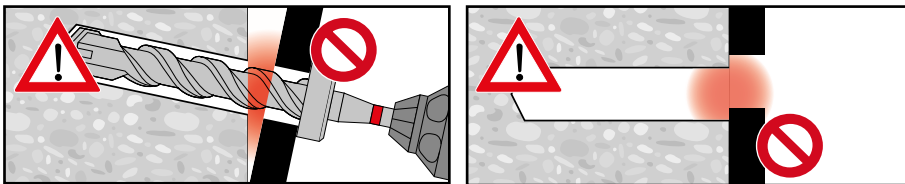

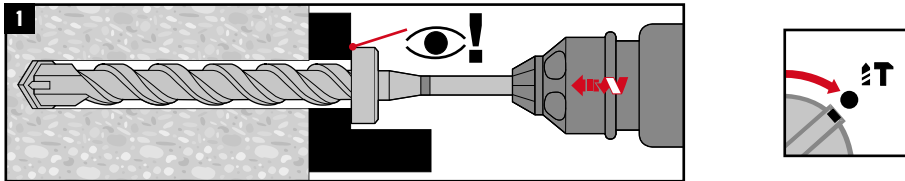





	HDA-T	max. $t_{fix}$	$d_f$
	HDA-T M10 x 160/20	20 mm	21 mm
	HDA-T M12 x 185/30	30 mm	23 mm



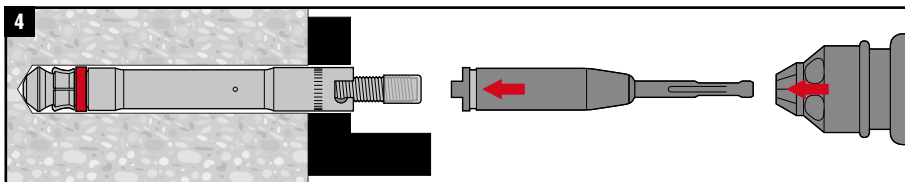
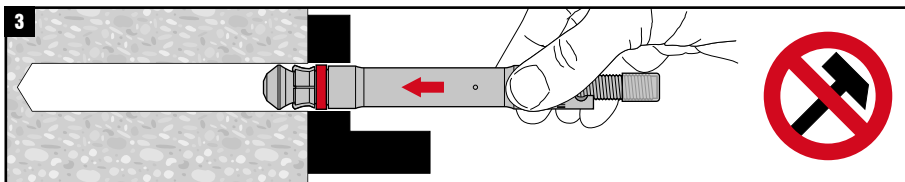
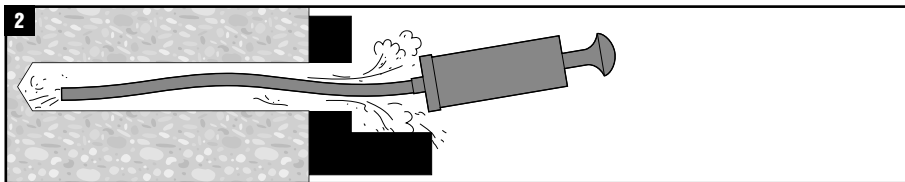



	HDA-T		TE-C (SDS plus)		TE-Y (SDS max)
HDA-T M10 x 160/20		TE-C-HDA-B 20 x 180		TE-Y-HDA-B 20 x 180	
HDA-T M12 x 185/30		TE-C-HDA-B 22 x 215		TE-Y-HDA-B 22 x 215	

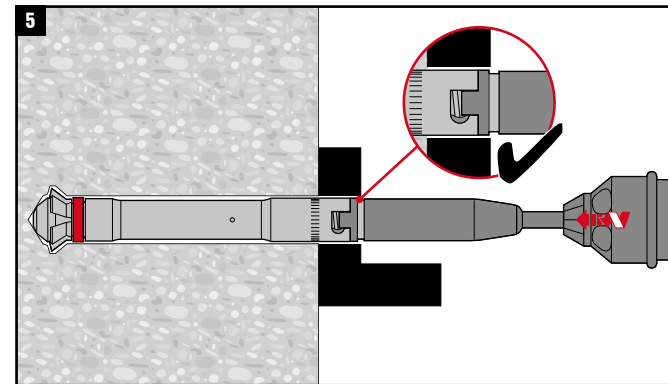

<b>4.1</b>		HDA-T		TE-C (SDS plus)		TE-Y (SDS max)
	HDA-T 20-M10 DE		-		TE 76	
	HDA-T 22-M12 DE		-		TE 56	



<b>4.2</b>		HDA-T		TE-C (SDS plus)		TE-Y (SDS max)
	HDA-T 20-M10 DE		-		TE-Y-HDA-ST20-M10	
	HDA-T 22-M12 DE		-		TE-Y-HDA-ST22-M12	

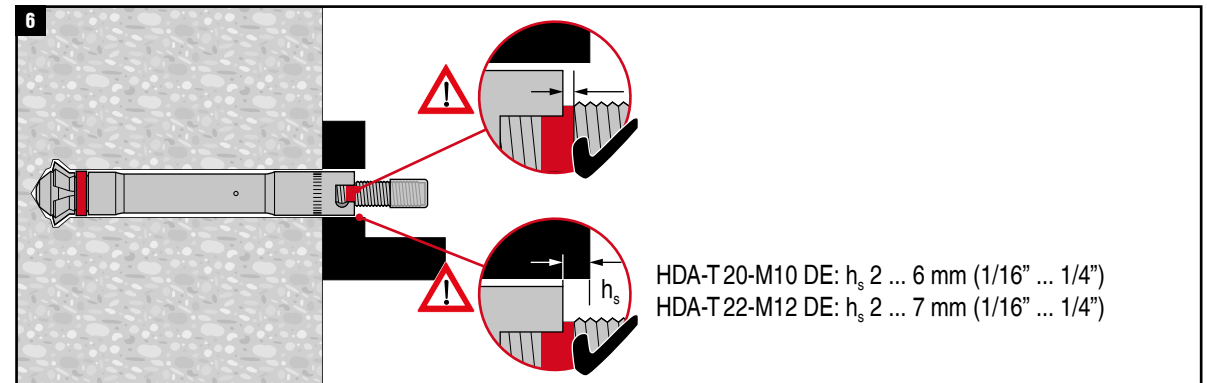

HDA-T 20-M10 DE	
	 $t_{setting}$
TE 76	 10 ... 20 sec (max. 30 sec)

HDA-T 22-M12 DE	
	 $t_{setting}$
TE 56	 10 ... 20 sec (max. 30 sec)



<b>7</b>		HDA-T		SW		$T_{inst}$
	HDA-T 20-M10		17		50 Nm (37 ft-lb)	
	HDA-T 22-M12		19		80 Nm (59 ft-lb)	