

HILTI

DST 10-E

Operating instructions

en



CE

DST 10-E electric wall saw

It is essential that the operating instructions are read before the machine is operated for the first time.

Always keep these operating instructions together with the machine.

Ensure that the operating instructions are with the machine when it is given to other persons.

Contents

1	General information	3
2	Description	5
3	Accessories	6
4	Technical data	8
5	Safety instructions	10
6	Preparations at the workplace	17
7	Setting up the system	20
8	Before use	30
9	Care and maintenance	38
10	Troubleshooting	42
11	Disposal	49
12	Manufacturer's warranty	50
13	EC declaration of conformity (original)	51

In these operating instructions, the designation “the machine” always refers to the DST 10-E electric wall saw.

Overview of parts



- ① Saw head
- ② Remote control unit
- ③ Transport trolley
- ④ Accessories box
- ⑤ Toolbox
- ⑥ Blade guard side section
- ⑦ Blade guard center section
- ⑧ Guide rail with end stop

1 General information

1.1 Safety notices and their meaning

DANGER

Draws attention to imminent danger that will lead to serious bodily injury or fatality.

WARNING

Draws attention to a potentially dangerous situation that could lead to serious personal injury or fatality.

CAUTION

Draws attention to a potentially dangerous situation that could lead to slight personal injury or damage to the equipment or other property.

NOTE

Draws attention to an instruction or other useful information.

1.2 Explanation of the pictograms and other information

Warning signs



General warning



Warning: electricity



Warning: sharp edges

Obligation signs



Wear eye protection.



Wear protective gloves.



Wear safety shoes.

Symbols



Read the operating instructions before use.



Wear ear protection.



Use the intended lifting points.

V

Volts

A

Amps

Hz

Hertz

∅

Diameter

mm

Millimeters

n

Rated speed

/min

Revolutions per minute

RPM

Revolutions per minute

On the saw head



To avoid damage to the equipment, water pressure must not exceed 6 bar.

To avoid damage when temperatures below freezing are expected, the cooling system must be fully drained by blowing out with air pressure. Please refer to the instructions for blowing out.

On the transport trolley

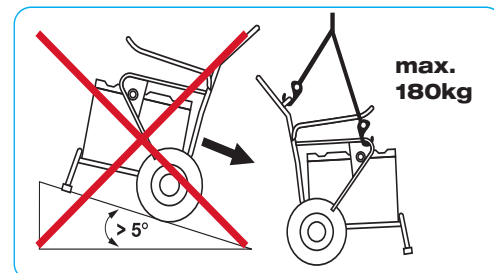

The transport trolley may become unstable or run away if stood on an inclined surface.

1 General information

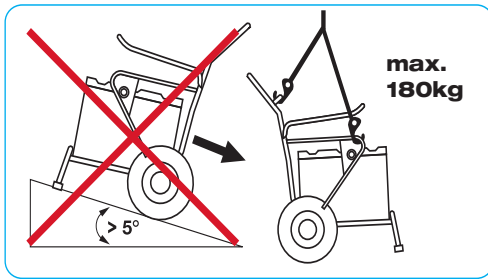

The transport trolley may be lifted by crane only at the lifting points intended for this purpose.

Location of identification data on the machine

The type designation, item number, year of manufacture and technical status of the machine can be found on the type plate. The serial number is marked on the side of the saw head beside the locking lever. On the remote control unit it is marked on the side of the casing. Make a note of this data in your operating instructions and always refer to it when making an enquiry to your Hilti representative or service department.

Type: DST 10-E saw head

Generation: 01

Serial no.:

Type: DST-RC 10 remote control unit

Generation: 01

Serial no.:

2 Description

2.1 Use of the product as directed

The DST 10-E is an electrically-powered, rail-guided wall saw designed for cutting reinforced concrete (containing light to moderate reinforcement), stone or masonry structures with diamond saw blades of 600 mm, 800 mm, 900 mm in diameter (maximum blade diameter for the initial cut is 800 mm).

All functions of the machine can be controlled by an electric remote control unit.

Thanks to load-dependent advance control, the machine is very easy to operate.

Best sawing performance is achieved when the DST 10-E is used with the specially-matched Hilti wall saw blades.

Use only diamond wall saw blades that comply with EN 13236 and which have been approved for use at a peripheral cutting speed of at least 63 m/s.

Use only anchors of adequate size and load capacity to secure the machine to the working surface.

Do not cut materials that may release hazardous or explosive dust or vapors during the cutting process (e.g. asbestos).

Do not cut easily flammable materials.

Overhead sawing is possible only when additional precautionary measures are taken.

For this application, the blade guard must be equipped with a means of water drainage.

Do not stand beneath the saw when it is used in this way.

Please consult your Hilti representative for further information and advice.

Use only genuine Hilti accessories (available as options) for angled or stepped cuts or for flush cutting.

Check that the electric supply provided at the construction site is always equipped with an earth/ground conductor and a ground fault circuit interrupter (PRCD type A, trigger

current max. 30 mA) and that these are connected.

2.2 Items supplied

- 1 Saw head
- 1 Remote control unit
- 1 Tool set
- 1 Operating instructions
- 1 DS-BG80 blade guard for blade diameters up to max. 900 mm
- 4 Rail supports
- 1 Transport box
- 1 Transport trolley
- 1 Tapered connector
- 3 Eccentric pins

With the aid of the accessories listed, the machine can be equipped to suit the types of work you carry out.

3 Accessories

3 Accessories

3.1 Accessory 1

Item number	Designation	Description
284808	DS-R100-L rail	Saw head guidance
284809	DS-R200-L rail	Saw head guidance
284810	DS-R230-L rail	Saw head guidance
371703	DS-ES-L end stop	Safety stop for saw head
207137	DS-CP-ML rail clamp	Fastening rails
284814	DS-RF-L rail support	Fastening rails
284816	DS-RFP-L rail support	For cutting at an angle or on stairs
232241	D-CO-ML double taper	Extending rails
232244	D-EP-ML eccentric pin	Extending rails

3.2 Accessory 2

Item number	Designation	Description
238000	DS-BG65 blade guard	Blade guard for blades up to 650 mm dia.
238002	DS-BG80 center section ¹	Blade guard for 600 mm to 900 mm dia. saw blades
238003	DS-BG80 side section	Blade guard for 600 mm to 900 mm dia. saw blades

¹ to be used only complete with the appropriate side sections

3.3 Accessory 3

Item number	Designation	Description
238006	DS-BGF80 center section ¹	Blade guard for 600 mm to 900 mm saw blades for flush cutting
238007	DS-BGF80 side section	Blade guard for 600 mm to 900 mm saw blades for flush cutting

¹ to be used only complete with the appropriate side sections

3.4 Accessory 4

Item number	Designation	Description
258436	DS-FCA-110 flush-cutting flange	Saw blade mounting flange for flush cutting
307188	DS-FCA-110FF auxiliary flange	Saw blade mounting flange for flush cutting

3 Accessories

3.5 Accessory 5

Item number	Designation	Description
430580	DST-TS10 tool set	Fastening rails, personal protection, maintenance and operation

3.6 Accessory 6

Item number	Designation	Description
400768	RC extension cable	Extending the distance between remote control unit and saw head from 10 to 20 m.

4 Technical data

4 Technical data

Right of technical changes reserved.

Technical data for the DST 10-E saw head

Rated values guaranteed at max. 18°C and heights of up to 2,000 m above sea level.

Power rating ¹	9 kW
Rated speed	160... 1,275/min
Rated voltage ²	380... 400 V
Voltage tolerance	+/- 10 %
Mains frequency	50 / 60 Hz
Mains connection (phase requirements)	3P+PE
Rated current	16 A
Mains fuse rating min. / max.	16 A
Saw blade diameter	600... 900 mm
Max. blade diameter for initial guide cut	Max. 800 mm
Max. cutting depth	Max. 38 cm
Weight	32 kg
Dimensions l × b × h	36.5 × 40 × 35 cm
Storage temperature ³	-25... +63°C
Ambient temperature range during operation ³	-15... +45°C
Generator power rating	Min. 20 kVA @ 16 A
Ground fault circuit interrupter in supply	30 mA
Leakage current	≤ 10 mA
Insulation resistance	> 2 MΩ
Cooling water temperature	Flow rate 4 l/min: +4... +30°C
Cooling water pressure	2... 6 bar
Protection class ⁴	IP 65

¹ Continuous operation 100%

² Power output is reduced at voltages below 370 V.

³ At temperatures below zero, allow the machine to warm up slowly before subjecting to load and drain (blow out) the water from the cooling circuit after use (a pump is supplied for this purpose).

⁴ Protection class IP65 in accordance with EN 60529:2000-09, 6 = protection against entry of dust, 5 = protection against water jets ("hose proof")

Technical data for the DST-RC 10 remote control unit

Cable length	10 m
Supply voltage	24 V
Protection class ¹	IP 65

4 Technical data

Weight	2.2 kg
Dimensions l × w × h	39 × 19 × 12.5 cm
¹ Protection class IP65 in accordance with EN 60529:2000-09, 6 = protection against entry of dust, 5 = protection against water jets ("hose proof")	

Technical data for the transport trolley

Dimensions l × w × h	loaded: 110 × 69 × 118 cm
Weight loaded ¹	100 kg
Permissible total weight	Max. 180 kg
¹ Contents in accordance with list of items supplied	

Noise information (measured in accordance with EN 15027)

Wear ear protection!

Note: The noise pressure level can be reduced by approx. 10 dB(A) when noise-reducing (silent) saw blades are used.

Typical A-weighted sound power level	114.5 dB (A)
Typical A-weighted sound emission pressure level	96.9 dB (A)
Uncertainty for the given sound level	3 dB (A)

5 Safety instructions

5 Safety instructions

WARNING

Failure to observe warnings and safety instructions may lead to potentially fatal injury and serious damage to property or equipment.

5.1 Proper organization of the workplace



- a) Approval must be obtained from the site engineer or site management before beginning drilling and sawing work. Drilling and sawing work on buildings and other structures may influence the statics of the structure, especially when steel reinforcing bars or load-bearing components are cut through.
- b) **Ensure that the workplace is well lit.**
- c) **Ensure that the workplace is well ventilated.** Exposure to dust at a poorly ventilated workplace may result in damage to the health.
- d) **Keep the workplace tidy. Objects which could cause injury should be removed from the working area.** Untidiness at the workplace can lead to accidents.
- e) Falling or other uncontrolled movement of the blocks cut free could cause injury or damage. Suitable means (e.g. steel wedges or supports) must be used to avoid uncontrolled movement of the blocks and prevent them falling.
- f) Ensure that adequately-sized supports are correctly installed so that the remaining structure maintains its stability after completion of the cutting work and removal of the part cut away.
- g) Never loiter beneath a load suspended by a crane or lifting equipment.
- h) The area of the cut or the opening created by the cutting process must be safely and visibly cordoned off in order to avoid the risk of persons falling.
- i) Wear personal protective equipment. Wear safety shoes or boots, protective gloves, ear and eye protection and, when required, a hard hat.
- j) Certain types of dust, e.g. mineral dust, are considered to be carcinogenic (cancer-causing). Wear respiratory protection if the work causes dust.
- k) **Dress properly for the work. Do not wear loose clothing or jewelry as it could be caught in moving parts. Contain long hair.**
- l) **Keep children away. Keep other persons away from the working area.**
- m) **The machine is not intended for use by children, by debilitated persons or those who have received no instruction or training.**
- n) **Children must be instructed not to play with the machine.**

5 Safety instructions

- o) Dust from material such as paint containing lead, some wood species, minerals and metal may be harmful. Contact with or inhalation of the dust may cause allergic reactions and/or respiratory diseases to the operator or bystanders. Certain kinds of dust are classified as carcinogenic such as oak and beech dust especially in conjunction with additives for wood conditioning (chromate, wood preservative). Material containing asbestos must only be treated by specialists. **Where the use of a dust extraction device is possible it shall be used. To achieve a high level of dust collection, use a suitable vacuum cleaner of the type recommended by Hilti for wood dust and/or mineral dust together with this tool. Ensure that the workplace is well ventilated. The use of a dust mask of filter class P2 is recommended. Follow national requirements for the materials you want to work with.**
- p) Do not allow other persons to touch the equipment or the extension cable.
- q) **Avoid unfavorable body positions. Make sure you work from a safe stance and stay in balance at all times.**
- r) To avoid presenting a tripping hazard, always ensure that cables and hoses leading to the machine are laid flat on the floor.
- s) Keep cables and hoses away from rotating parts.
- t) Gas and water or other pipes and electric cables present a serious hazard if damaged while the work is in progress. In cooperation with the site engineer or architect, check to ensure that no gas, water, electricity or other supply lines are located in the cutting area. External metal parts of the machine could become live if, for example, an electric supply cable is damaged.
- u) Water that is allowed to flow away or spray around in an uncontrolled manner can lead to damage or accidents. The fact that water could drain away into internal, hidden cavities, e.g. in brickwork or masonry, must also be taken into account. Ensure that the cooling water used is drained or extracted in a suitably controlled manner.
- v) **Don't work from a ladder.**

5 Safety instructions

5.2 Safety measures at the danger areas

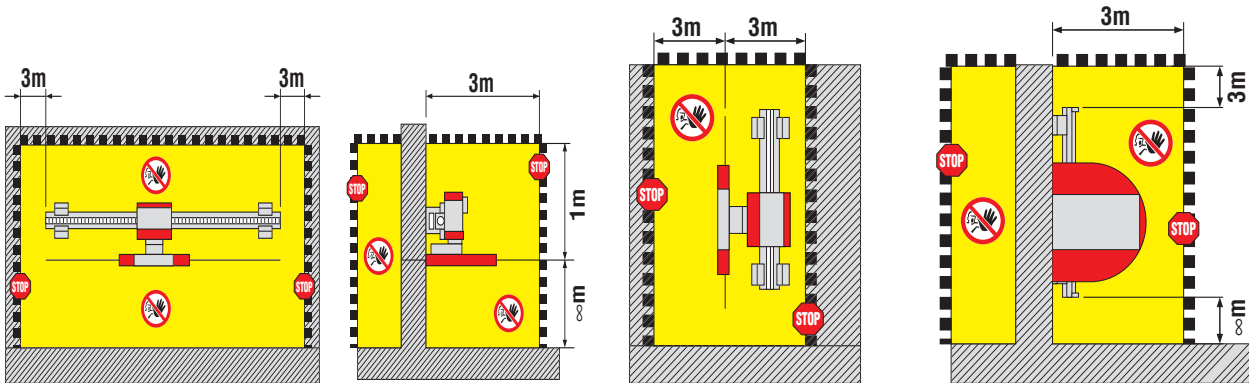

Safety measures must be implemented in the working area to ensure that operators and bystanders cannot be injured or property damaged by falling objects or flying debris (broken-off diamond segments, small stones, sawing slurry, etc.) while sawing is in progress.

Safety measures must also be implemented in the area not directly visible to the operator, i.e. at the rear of objects being cut.

Persons must NEVER enter the danger area while the blade drive is switched on. The danger area is marked in yellow in the illustrations.

CAUTION

Secure the working area. Ensure that no persons can be injured or property / equipment damaged by falling objects or debris that may fly off during the sawing operation.

Make sure that approval is obtained from the site engineer or site management before beginning the sawing work.

Find out whether overcutting at corners is permitted. If not, the corresponding corner holes must be planned and drilled first.

Make sure that the area is cordoned off, that supports are in place and warnings to third parties are displayed.

When setting up and operating the saw system and when removing parts that have been cut away, always ensure that no persons are below the area in which you are working.

NOTE

Falling objects could cause serious injury.

5.3 General safety rules

- a) Use the machine only when you have read the operating instructions, when you are familiar with the information the instructions contain, and when you have received training from a Hilti specialist on how to use the machine safely. Observe all warnings and instructions.
- b) **Use the right tool or machine for the job. Do not use the tool or machine for purposes for which it was not intended. Use it only as directed and when in faultless condition.**
- c) Use of this machine for operations other than those intended could result in hazardous situations. Use the machine, accessories and saw blades etc., in accordance with these instructions and in the manner intended for this particular type of machine. In doing so, the working conditions and the tasks to be performed must be taken into account.
- d) **Use only the genuine Hilti accessories or ancillary equipment listed in the operating instructions.** Use of accessories or ancillary equipment not listed in the operating instructions may present a risk of personal injury.
- e) Electric tools and machines generate sparks which may ignite dust or gas. Take the influences of the surrounding area into account. Do not use the machine where there is a risk of fire or explosion.
- f) Keep the grips dry, clean and free from oil and grease. Before releasing the saw head locking levers, make sure you are holding the saw head securely.
- g) **Do not overload the machine. It will work more efficiently and more safely within its intended performance range.**
- h) Never leave the machine unattended.
- i) Store appliances in a secure place when not in use. When not in use, appliances must be stored in a dry place, locked up or out of reach of children.
- j) Always unplug the machine from the electric supply when it is not in use (e.g. during breaks between working), before making adjustments and before carrying out care and maintenance. This safety precaution prevents the machine starting unintentionally.
- k) Remove any adjusting key or wrench before switching the machine on. A wrench or a key left attached to a rotating part of the machine may result in personal injury.
- l) Before use, the machine, the saw blade and accessories must be checked carefully to ensure that all items function faultlessly and as intended. Check that moving parts function correctly without sticking and that no parts are damaged. All parts must be fitted correctly and fulfill all conditions necessary for correct operation. Damaged parts must be repaired or replaced properly by an authorized service center.
- m) Avoid skin contact with drilling and sawing slurry. In the event of contact with the eyes, rinse immediately with clean water and consult a doctor if necessary.
- n) Wear a protective mask during work that generates dust, e.g. dry cutting. Connect a dust removal system. Working on materials hazardous to the health (e.g. asbestos) is not permissible.
- o) Follow the instructions concerning care and maintenance.

5 Safety instructions

5.4 Electrical safety



- a) There is an increased risk of electric shock if your body is earthed or grounded. Take steps to avoid electric shock. Avoid body contact with earthed or grounded surfaces such as pipes, radiators, ranges and refrigerators.
- b) Check the machine's supply cord at regular intervals and have it replaced by a qualified electrical specialist if found to be damaged. Check extension cords at regular intervals and replace them if found to be damaged.
- c) Check the condition of the machine and its accessories. Do not operate the machine and its accessories if damage is found, if the machine is incomplete or if its controls cannot be operated faultlessly.
- d) If an electric cable is damaged while working, don't touch the cable or the machine. Press the EMERGENCY OFF button and unplug the supply cord from the electric supply.
- e) Damaged or faulty switches must be replaced at a Hilti service center. Do not use the machine if it cannot be switched on and off correctly.
- f) **Have the machine repaired only by a trained electrical specialist (Hilti service center) using genuine Hilti spare parts. Failure to observe this point may result in risk of accident to the user.**
- g) **Do not use the supply cord for purposes for which it is not intended. Never carry the machine by the supply cord. Never pull the plug out of the power outlet by pulling the supply cord.**
- h) **Do not expose the supply cord to heat, oil or sharp edges.**
- i) Sawing inadvertently into a live cable presents a risk of fatal accident if the machine is not earthed/grounded or the insulation on a part of the machine is faulty. Connect the machine and its ancillary equipment only to a power source equipped with an earth/ground conductor and ground fault circuit interrupter (PRCD). Check that these items are in perfect working order before operating the equipment. Install an earth/ground rod if a generator is used or if no earth/ground conductor is present in the on-site electric supply. Operation of the machine without an earth/ground connection is not permissible under any circumstances.
- j) Make sure that the mains voltage corresponds to the specification given on the type plate.
- k) Electric cables and their plug connectors must be kept dry. When not in use, close power outlets with the cover provided.
- l) Use only extension cables of a type approved for the application and with conductors of adequate gauge. Do not use extension cables that are still rolled up. This can result in a drop in output at the equipment and may cause the cable to overheat.
- m) Disconnect the power cable before beginning cleaning and maintenance work or in the event of an interruption between periods of operation.
- n) Please note that certain components within the casing retain an extremely dangerous (potentially fatal) high voltage for up to 10 minutes after disconnection from the electric supply.

5.5 Requirements to be met by users

- a) The machine may be operated only by specialists trained in concrete cutting techniques, referred to in the following as “operators”. These persons must be fully familiar with the content of these operating instructions and must have been trained in their safe application by a Hilti specialist.
- b) A moment of inattention could result in serious injury. Stay alert, watch what you are doing and use common sense when working. Don't use the machine when you are tired or under the influence of drugs, alcohol or medication.
- c) Wear personal protective equipment. Wear safety shoes or boots, protective gloves, ear and eye protection and, when required, a hard hat.
- d) Always operate the machine from the closed side of the blade guard, i.e. the protected side, when corner cuts are made with the blade guard in the partly open position. The operator must take additional precautions (fit a cover, plank of wood, boards etc.) where necessary.
- e) Never enter the danger area (e.g. to change the saw blade, remove the blade guard side section, hammer in wedges, etc.) before the blade drive is switched off and the blade has come to a standstill. Press the EMERGENCY STOP button before entering the danger area.
- f) Do not touch rotating parts. Keep the grips dry, clean and free from oil and grease.
- g) Adhere to the permissible drive unit parameters and recommended guide values for blade rotation speed and advance speed while sawing.

5.6 Safety during operation

- a) Check that the wall saw and its components, the saw blade and all accessories are in good condition and in perfect working order before use. Make sure that any damage or malfunctions are rectified in a **professional** manner before operation commences.
- b) A falling object could result in serious personal injury or damage to property or equipment. Sawing may begin only once the wall saw system (rail supports) have been fastened securely to a solid surface and the other parts of the system have been assembled or installed correctly (all bolts tightened, the saw head positioned securely on the rail, locking levers closed, end stops fitted).
- c) NEVER stand in the direction of radial flight of the saw blade. Always use the appropriate blade guard (DS-BG for normal cutting, DS-BGF for flush cutting).
- h) Use only saw blades that comply with the requirements of EN 13236. Use of blades beyond the specified diameter range is not permissible. Fit the blades the right way round (observe correct direction of rotation).
- i) Use of blades with laser-welded segments can reduce the risk of segments breaking and flying off.
- j) Check the blade mounting flange and blade for damage (e.g. cracks in the steel disc) and degrease the blade mount each time before operating the wall saw.
- k) The saw blade may get hot. Always put on gloves before touching it.
- l) Use only fastening materials of adequate size (anchors, bolts, etc.) to fasten the rail supports and to secure the part being cut away.
- m) Use of accessories other than the recommended genuine Hilti accessories may result in personal injury or damage. Use only the accessories recommended in these operating instructions.

5 Safety instructions

- n) If equipment such as scaffolding, platforms or ladders is used, check that this equipment complies with regulations, that it is undamaged and set up in accordance with regulations.
- o) The operator must make sure that no persons enter or loiter in the danger area at any time while the saw is in operation. This also applies to the area not immediately visible to the operator, i.e. the area behind or below the object in which the cut is being made. If necessary, a large area must be cordoned off or security personnel posted.
- p) Stay alert at all times. Monitor the progress of the sawing operation and keep an eye on the cooling water system and the area surrounding the workplace. Do not operate the machine if your full attention is not on the job.
- q) No modifications may be made to the saw system. Modification of the factory-set drive parameters is strictly prohibited.
- e) The machine may be lifted by crane only at the lifting points provided using tested and approved lifting gear. Before lifting, check that all removable items of equipment are securely attached to the transport trolley or locked in position. Use of the trolley to transport rails with a length of more than 1.5 meters is not permissible. Never loiter beneath a load suspended by a crane or lifting equipment.
- f) The trolley is intended to be used for transporting the saw system and the specified accessories. The trolley must not be used to transport other items.

5.7 Safety instructions for transportation

- a) Avoid lifting and carrying heavy objects. Use suitable lifting equipment and means of transport and share heavy loads between several people.
- b) Use the grips provided for transportation. Keep the grips dry, clean and free from oil and grease.
- c) Bear in mind that the machine could fall over. Stand it only on a solid, level surface.
- d) Secure the saw system and its components to prevent inadvertent movement or falling over during transportation.

6 Preparations at the workplace

6.1 Planning the cutting sequence, marking the cutting line and fastening points

NOTE

The parts to be cut out are usually marked by the client. A rational cutting sequence can be followed when the rail supports are cleverly positioned.

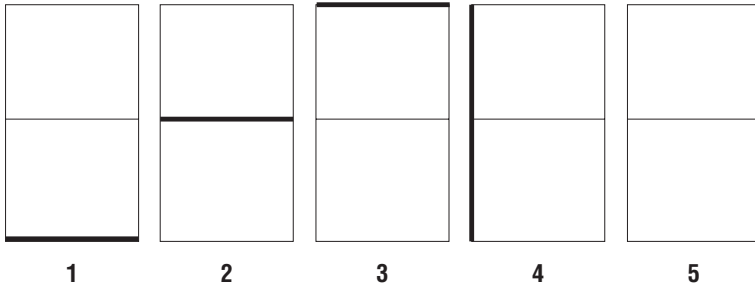

If necessary, make dividing cuts to adjust the size and weight of the concrete blocks to the prevailing conditions (i.e. the lifting capacity of the crane or the maximum permissible floor loading capacity and size of doors).

Use steel wedges and supports, as necessary, to secure the cut sections of concrete.

6.2 Safety aspects to be clarified

Make sure there are no hazardous pipes or cables (gas, water, electricity etc.) in the cutting area.

Make sure that the effects of the cutting work on the stability of the structure have been clarified and that all supports are capable of taking up the resulting loads.

Make sure that the possibility of hazards or damage as a result of the cooling water used can be ruled out.

Make sure that safety measures have been implemented to ensure that no persons can be injured or property and equipment damaged by falling objects or debris that may fly off during the sawing operation.

Make sure that the parts of the structure to be sawn out can be removed safely in a controlled operation and subsequently disposed of.

Check that the electric supply and water supply available for use meet the specified requirements.

Check that the required equipment in the correct specification is available for use.

Make sure that the work to be carried out has been approved in full by the site engineer or architect.

6 Preparations at the workplace

6.3 Electric power supply / fuse rating

CAUTION

Irrespective of whether using mains power or generator power, always check that an earth/ground conductor and ground fault circuit interrupter are present in the power supply and that these are connected.

Check that the fuse rating of the electric power supply at the construction site is as follows:

Voltage version 3 × 380 ... 400 V

Fuse rating	16 A
Ground fault circuit interrupter (FI)	Type A 30 mA

6.4 Electric power connection / power cable plugs

Pin assignment

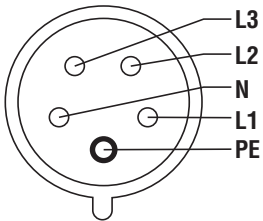

L1	Phase 1
L2	Phase 2
L3	Phase 3
N	Neutral conductor (not required)
PE	Earth / ground conductor

Voltage version	3 × 400 V
Pin assignment	3P + N + PE - 16 A

NOTE

The remote control unit displays the electric supply voltage and indicates an error if any one of the phases (L1, L2, L3) provides no power.

6.5 Extension cables / conductor cross section

Make sure that only extension cables approved for the intended field of use and with conductors of adequate cross section are used. The cable may otherwise overheat. In accordance with EN 61029-1 the conductor cross section must be at least 1.5 mm² for 16 A (conductor cross section = cross sectional area of each conductor).

Inadequate conductor cross sections and long cables lead to a drop in voltage and, accordingly, to a loss of performance.

Check to ensure that cables are fully unrolled before the wall saw is put into operation.

6 Preparations at the workplace

6.6 Cooling water supply

When the cooling water has a temperature of 25°C, a flow rate of approx. 2 l/min is required to cool the saw head.

The machine's automatic cut-out will be activated in the event of inadequate cooling.

Use only clean cooling water.

Where pressure in the water supply line is low, a non-return valve should be fitted in order to prevent dirty water finding its way into the water supply.

7 Setting up the system

7 Setting up the system

7.1 Rail supports

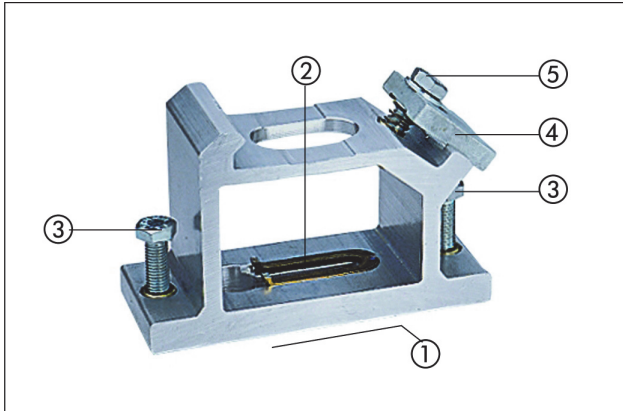

Rail support for regular cutting

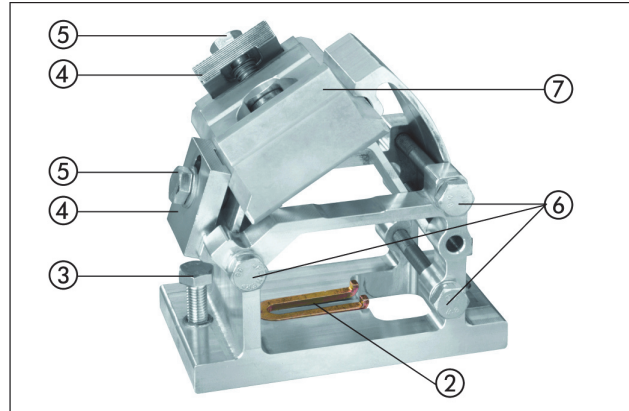

Rail support for cutting at an angle or on stairs

- ① Contact surface
- ② Anchor slot for fitting rail support
- ③ Leveling screws
- ④ Rail clamping plate
- ⑤ Rail clamping screw
- ⑥ Clamping screw for angle adjustment
- ⑦ Clamping plate for cutting on stairs

7.2 Fastening the rail supports

WARNING

Use an anchor suitable for the material on which you are working and observe the anchor manufacturer's instructions.

CAUTION

Positioning and spacing the rail supports at distances greater than those shown may cause the saw to wander off course and, in extreme situations, may result in failure of the anchor fastenings.

CAUTION

Adequately dimensioned fastenings of a type suitable for the applicable material are essential in order to ensure efficient and safe use of the equipment.

NOTE

Hilti M12 metal expansion anchors are usually suitable for fastening diamond core drilling equipment to uncracked concrete. Under certain conditions it may be necessary to use an alternative fastening method. Please contact Hilti Technical Service if you have any questions about secure fastening.

7 Setting up the system

WARNING

The HKD-D M12 anchor is unsuitable for use on cracked concrete, masonry and synthetic or natural stone or similar materials.

NOTE

During installation, the leveling screws should not project beyond the contact surface of the rail supports.

Use the DS-RFP rail support for angled and stepped cuts.

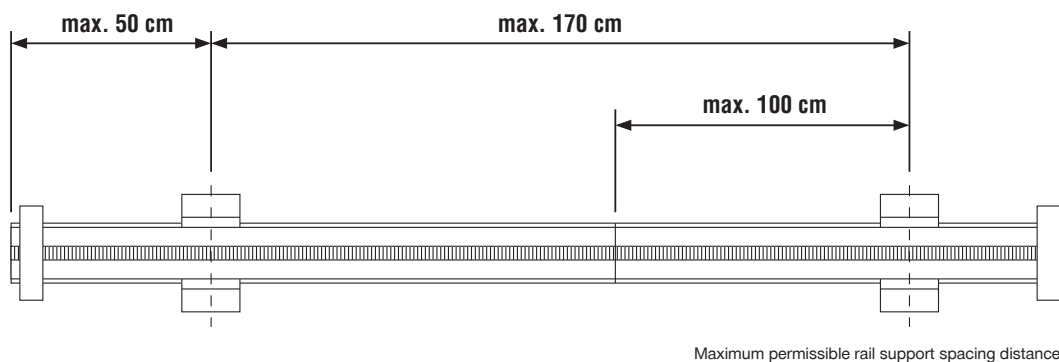
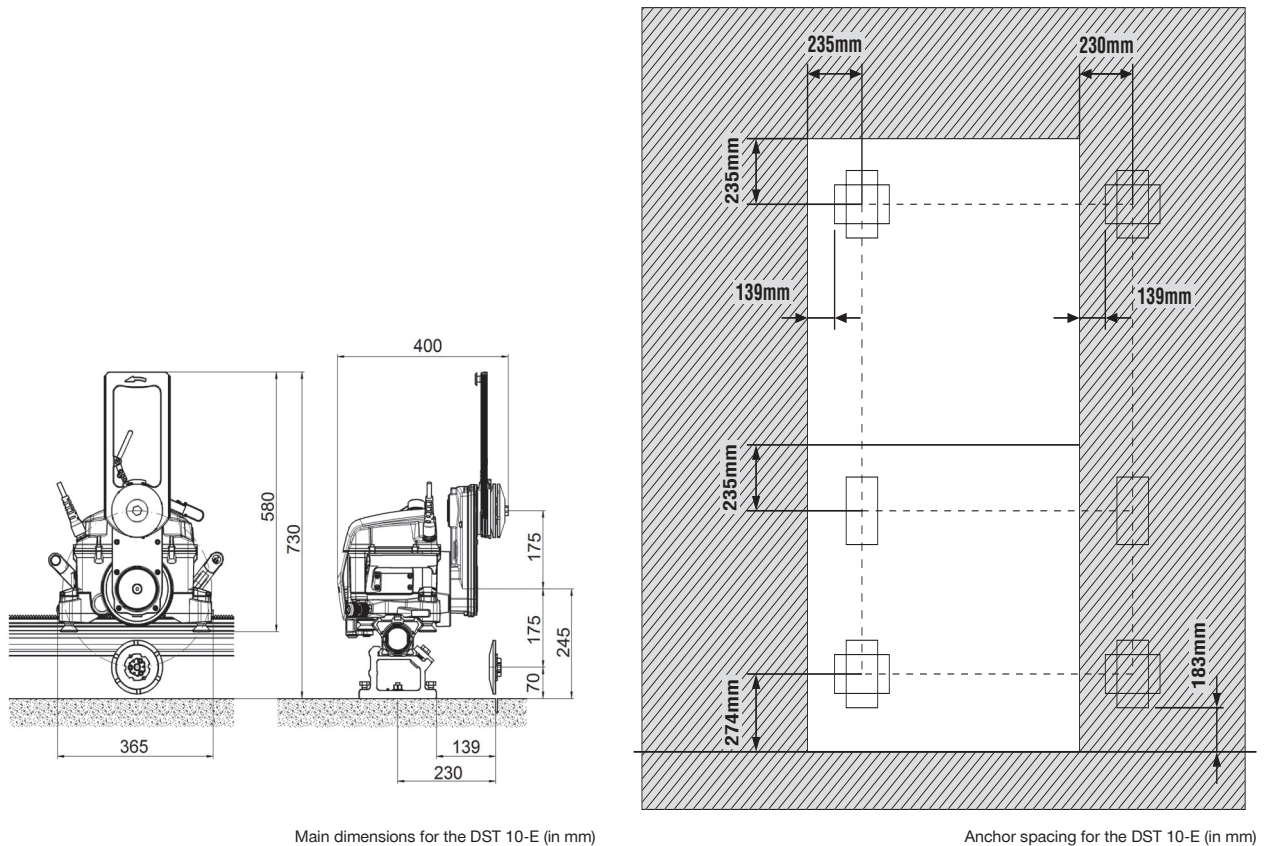

1. Mark the positions of the anchor holes for the rail supports.
2. Drill the anchor holes (depth and diameter in accordance with the manufacturer's instructions).

7 Setting up the system

3. Clean the holes (remove the drilling dust).
4. Insert and expand the anchors (e.g. Hilti HKD-D M12) using the setting tool.
5. Screw in the fastening screws (8.8 grade with collar nut, supplied in the accessory box) to their full depth by hand.



6. Position and align the rail supports and then tighten the collar nuts slightly.

7.3 Fitting the rail

NOTE

The rail clamps cannot be used with the rail supports for angular cutting.

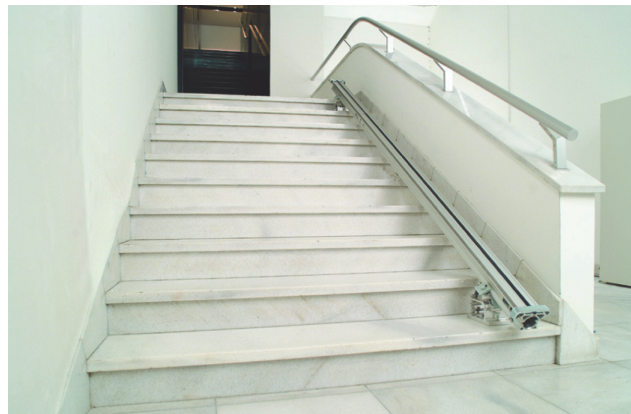
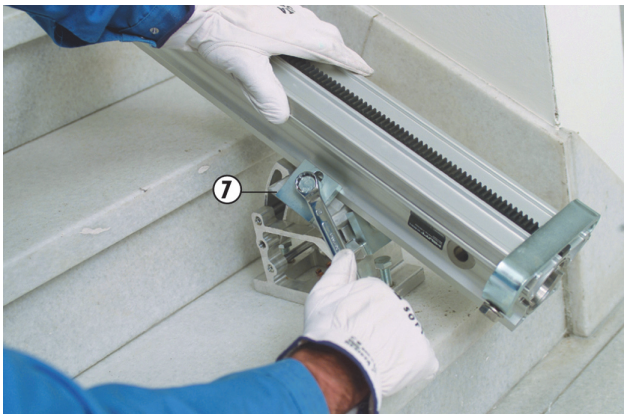
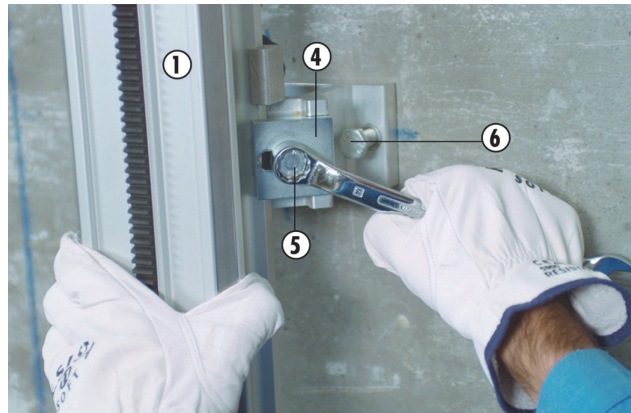
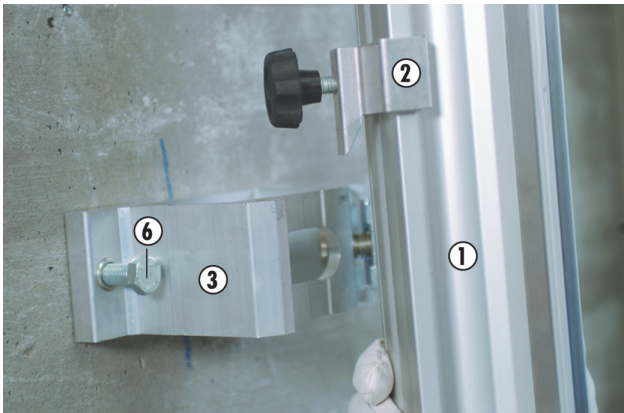

7 Setting up the system

- ① Rail
- ② Rail clamp
- ③ Rail support
- ④ Rail clamping plate
- ⑤ Rail clamping screw
- ⑥ Leveling screws
- ⑦ Clamping plate for cutting on stairs

1. Fit the rail clamp to the rail.
2. Position the rail with fitted rail clamp on the rail support and close the clamping plate.
3. Turn the rail support until at right angles to the rail and then tighten the clamping plate securely.
4. Compensate for any difference in level by adjusting the leveling screws.
5. Align the rail at the correct distance from the cutting line and then tighten the fastening screws.
See page: 23
6. Fit end stops at both ends of the rail.

7.3.1 Dimensions for setting up

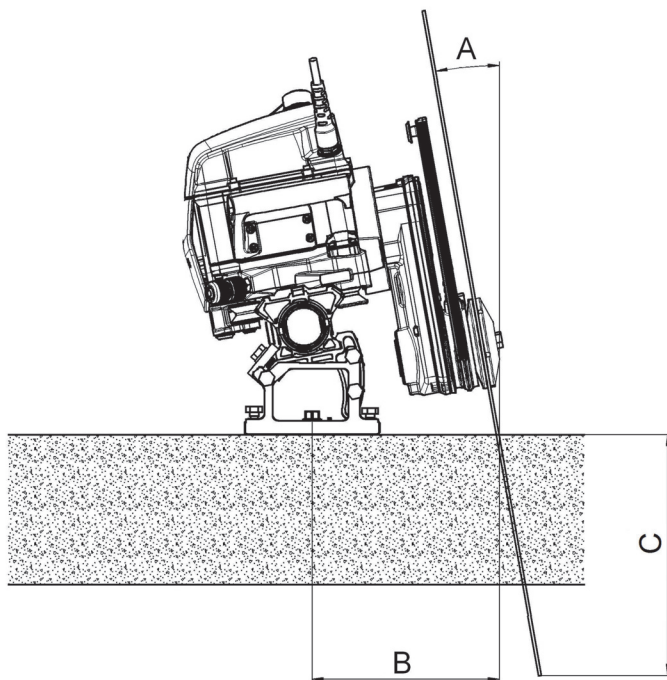

A	B	C			
		(Ø) 600 mm	(Ø) 700 mm	(Ø) 800 mm	(Ø) 900 mm
0°	23.0 cm	23.0 cm	28.0 cm	33.0 cm	38.0 cm

7 Setting up the system

A	B	C			
		(Ø) 600 mm	(Ø) 700 mm	(Ø) 800 mm	(Ø) 900 mm
5°	23.8 cm	19.9 cm	24.9 cm	29.9 cm	34.9 cm
10°	24.8 cm	17.1 cm	22.0 cm	26.9 cm	31.8 cm
15°	26.0 cm	13.9 cm	18.8 cm	23.7 cm	28.5 cm
20°	27.6 cm	10.8 cm	15.5 cm	20.2 cm	24.9 cm
25°	29.5 cm	7.5 cm	12.0 cm	16.5 cm	21.1 cm
30°	31.8 cm		8.3 cm	12.7 cm	17.0 cm
35°	34.6 cm			8.6 cm	12.7 cm
40°	38.1 cm				8.3 cm

7.4 Extending the rail

NOTE

When long cuts are to be made, tapered connectors and eccentric pins can be used to join individual rails together to form a rigid unit.



- ① Rail
- ② Tapered connector
- ③ Eccentric pins
- ④ 1/2" square drive wrench
- ⑤ Tapered sleeve

1. Clean the tapered connector and connector sleeves.
2. Insert the tapered connector and secure it with an eccentric pin.
3. Slide the rail onto the tapered connector and also secure it with an eccentric pin.
4. To release the connection, turn the eccentric pins in the opposite direction and push out the tapered connector.

7.5 Mounting the saw head

CAUTION

Before releasing the saw head locking levers, make sure you are holding the saw head securely.

NOTE

The DS-FCA-110 flush-cutting flange should be mounted on the saw head for flush-cutting applications.

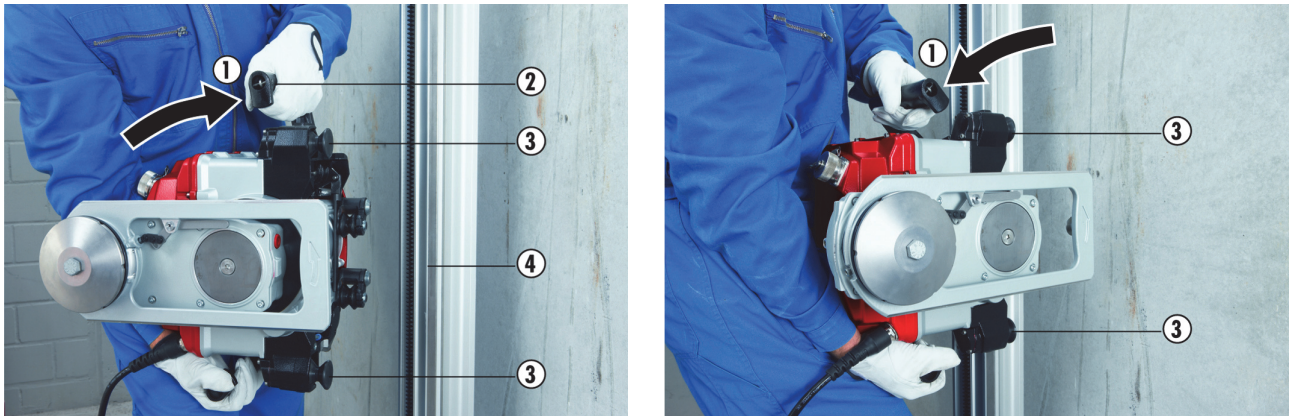

- ① Clamping lever with built-in release button
- ② Release button
- ③ Guide roller
- ④ Guiding surface

1. Press the release button ② and then push the clamping lever ① downwards and engage it in the lower position.
2. Position the saw head on the previously fastened rail.
3. Check that the guide rollers ③ are correctly aligned.
NOTE The center of the guiding surface ④ should be in line with the middle of the guide roller.
4. Press the release button ② and then pull the clamping lever ① upwards until it engages in position.
5. Continue to hold the saw head securely until you have checked the position of the guide rollers ③ on the guide rail and ensured that the clamping lever has engaged correctly (move the clamping lever back and forward).

7 Setting up the system

7.6 Adjusting the blade guard



- ① Blade guard holder
- ② Keyless clamping mechanism

1. Set the blade guard holder ① to the desired position (45°/90°/135°).
2. Apply slight pressure to the lever ② while rotating the blade guard holder until it is felt to engage and then push the lever fully into the locking position.
3. To release the mechanism, push the lever ② in the opposite direction into the open position.

7.7 Connecting the power cable, remote control cable and cooling water hose

CAUTION

When unplugging, always grip the plug and not the cable. Fit the protective cap immediately.

CAUTION

To avoid damage to the parts, check that the plug and socket are clean and in good condition before connecting. Clean the parts or remedy any damage before connecting them.

CAUTION

Don't allow the cables to become tangled. Position the cables carefully so that the plug connectors are not lying in water and so that the cables can follow movement of the saw head without coming under tension.

7 Setting up the system



- ① Socket for remote control cable
- ② Cooling water hose connector
- ③ Protective cap
- ④ Securing sleeve
- ⑤ Supply cord

1. Remove the protective cap.
2. Align the plug carefully with the socket and push it in all the way without using excessive force.
3. Close the securing sleeve and check that it engages.
4. Close the protective caps together.
5. Connect the cooling water hose.
6. Connect the power cable to the power source.

7.8 Fitting the saw blade

NOTE

Use the DS-FCA-110 flush-cutting flange and flush-cutting blade guard (available as accessories) for flush-cutting applications.

Use only the original Hilti screw (10.9 grade steel) as the central blade mounting screw.

Before operating the wall saw each time, always check the mounting flange and saw blade for damage, cracks or discoloration caused by overheating and clean the saw blade if it has been oiled or greased.

7 Setting up the system

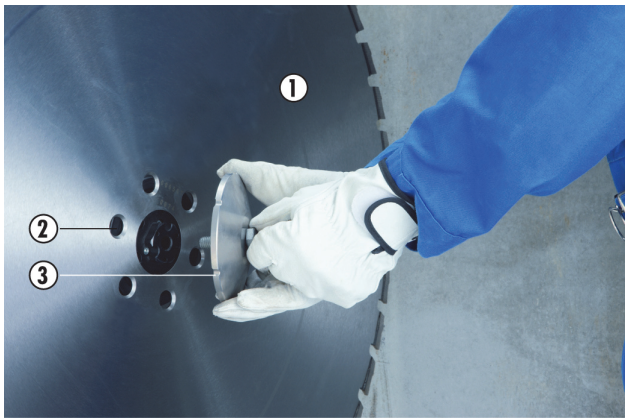

- ① Saw blade
- ② Centering and mounting flange
- ③ Blade flange
- ④ Clamping screw
- ⑤ Mounting holes for flush cutting

1. Position the saw blade ① on the saw arm, taking care to observe the correct direction of rotation.
2. Fit the blade flange ③ and mounting screw. Tighten the screw only slightly.
3. Align the saw blade ① so that the mounting holes for flush cutting ⑤ lie between the water grooves.
4. Tighten the mounting screw ④ securely with the 19 mm AF ring wrench (110 Nm).

7.9 Fitting the blade guard

NOTE

Should it prove impossible to use the blade guard due to specific circumstances at the working area, special measures must be taken, such as construction of a temporary enclosure (e.g. using forming boards), to protect the surrounding area from flying fragments etc. while sawing.

Use the DS-FCA-110 flush-cutting flange and flush-cutting blade guard (available as accessories) for flush-cutting applications.

Keep the metal hooks for the side sections clean in order to prevent jamming or sticking of the side sections.

Keep the blade guard clean. Clean it regularly each time after use to ensure that it remains in good working order.

CAUTION

Remove the side section only immediately before beginning a corner cut.

7 Setting up the system

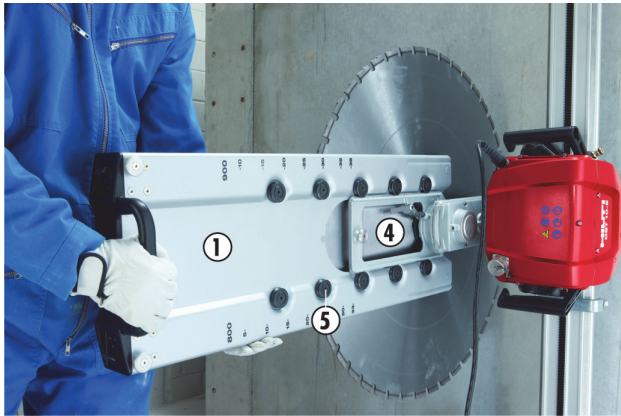

- ① Blade guard center section
- ② Blade guard side section
- ③ Metal hook
- ④ Blade guard holder
- ⑤ Guide wheels
- ⑥ Clamp
- ⑦ Tensioning lug
- ⑧ Rubber tensioning strap

1. Push the center section of the blade guard ①, or the complete blade guard, onto the blade guard holder ④.
2. Fit the blade guard side section by engaging both metal hooks ③ of the side section ② with the center section ① and then close the clamp ⑥.
3. Secure the blade guard to the blade guard holder by pulling the rubber strap ⑧ over the tensioning lug ⑦.
4. To remove the side section ②, open the clamp ⑥ and lift the side section away from the center section.

8 Before use

8 Before use

8.1 Checks before beginning sawing

On-site preparations must be completed (supports, water collection, etc.).

The danger zones in front of and behind the object where sawing is to take place must be secured and cordoned off. No persons may remain in a danger zone.

The power cable and water supply must be connected. The electric supply must be earthed / grounded and equipped with a ground fault circuit interrupter. The water supply must be within the permitted pressure range.

The rail supports and rails must be aligned and fastened correctly, with all screws and nuts tightened securely.

The saw head must be mounted correctly and the locking levers engaged. Move the locking levers back and forward slightly to check that they are engaged correctly.

The saw blade must be mounted in the correct direction of rotation and the mounting screw at the saw blade flange (or six countersunk screws for flush cutting) tightened securely.

The blade guard and end stops must be fitted securely.

The remote control unit must be connected.

The emergency stop button on the remote control unit must be disengaged and the reset button pressed.

All control knobs on the remote control unit must be in the “Off” or “Neutral” position.

The operator should be wearing the remote control unit (using the shoulder strap).

The “Ready” indicators must light up.

The safety precautions must be observed.

8.2 Functions of the remote control unit

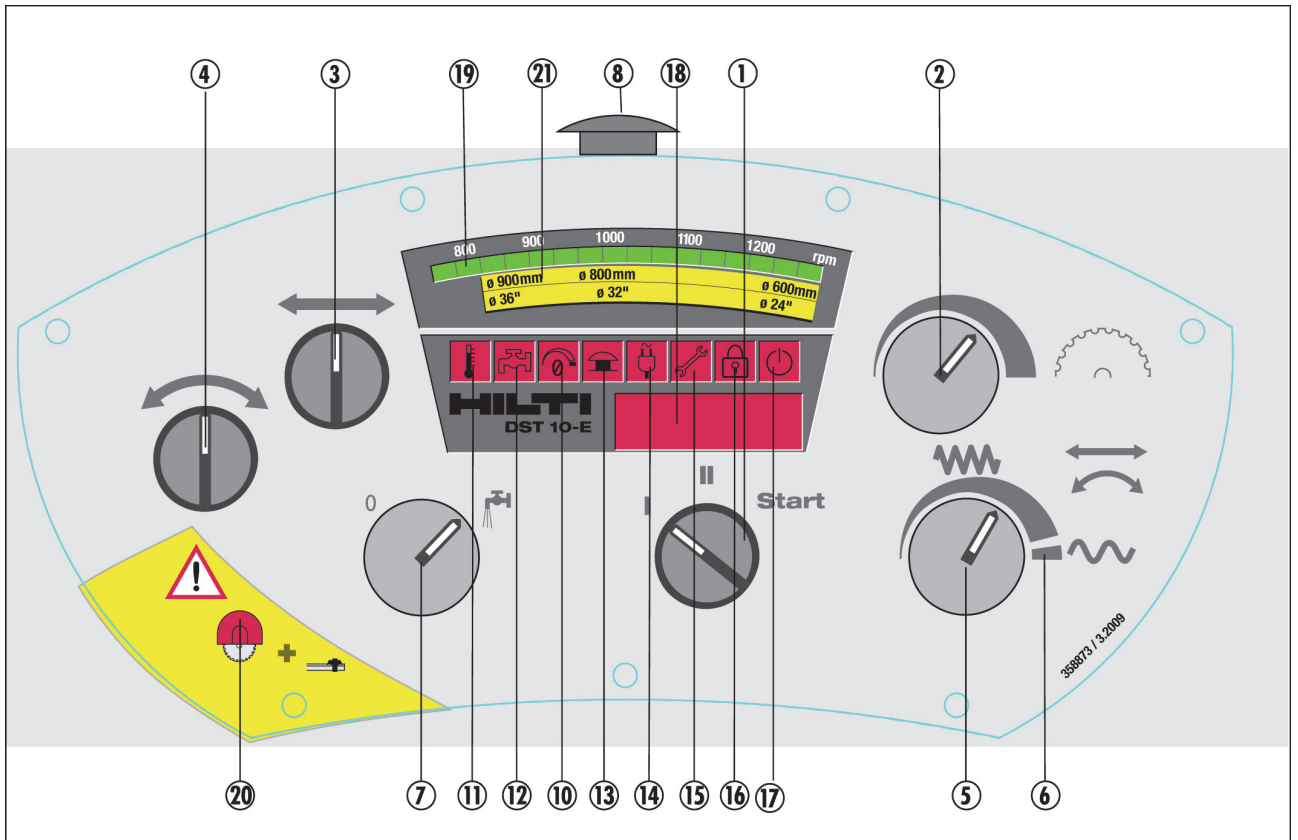

①	Saw blade drive on / off	Turn to start Position II Position I	Start the blade drive Saw blade drive running Saw blade drive "Off"
②	Saw blade speed	Smooth (stepless) speed regulation.	
③	Direction of advance movement	Switch controlling direction of advance of the saw along the rail.	
④	Direction of plunge movement	Switch controlling direction of blade plunge movement	

8 Before use

⑤	Speed regulation for advance and plunge movements.	Manual and / or automatic advance or plunge movement, power shown in display.	
⑥	Rapid advance and plunge movement.	For rapid movement in the advance and plunge directions.	
⑦	Cooling water on / off	Controls cooling water supply to saw blade. Water flows when power is switched off.	
⑧	Emergency off button	Press in an emergency! Leave pressed in when setting up or changing blades etc. Turn the button to release it.	
⑨	Emergency off reset button	Reset function, to be pressed after releasing the emergency off button.	
⑩	Zero position error	Lights when one or more knobs are not in the zero or neutral position when switching on.	
⑪	Overheating cut-out	Lights when the machine has switched itself off due to overheating.	
⑫	Temperature warning	Lights when cooling is inadequate.	
⑬	Emergency stop indicator	Lights when the emergency stop button is pressed or when it is not reset.	
⑭	Fault in the electric supply	Lights in the event of a phase fault, i.e. voltage too low, too high or out of synchronization.	
⑮	Service indicator	Lights when servicing is due (end of service interval). The machine should be serviced by Hilti.	
⑯	Theft protection	Not activated	
⑰	Emergency off indicator	Lights until reset button is pressed after emergency stop.	
⑱	Display	Software version	The currently installed software version is displayed when the power cable is plugged in.
		Operating hours counter	After switching on, the total time the saw head has been in operation is displayed (in hours).
		Power indicator	The actual power input is displayed (in %) and updated continuously during operation of the saw.
		Supply voltage	The supply voltage is displayed when the starting switch is turned to the "Start" position while the saw is in operation.
		Fault indicator	The code displayed can help to localize a possible fault (e.g. Er01).

⑱	Speed indicator	Shows the speed currently set (rpm = revolutions per minute).
⑳	Warning	Operation of the saw without blade guard and end stops fitted is not permissible.
㉑	Recommended speed range	

8.2.1 Reading the mains input voltage while the saw is in operation

Turn the start switch ① to the “Start” position and hold it there.

The voltage reading is shown in the display ⑱ in volts.

8.2.2 Reading the mains input voltage while the saw is stationary

1. Turn the starting switch ① to the “I” position.
2. Set the saw blade speed control knob ② to the maximum speed position.
3. Turn the start switch ① to the “Start” position and hold it there.
The voltage reading is shown in the display ⑱ in volts.

8.2.3 Reversing the switch positions controlling direction of advance

1. Turn the starting switch ① to the “I” position.
2. Turn the advance speed control knob ⑤ to the zero position.
3. Set the saw blade speed control knob ② to the maximum speed position.
4. Operate the direction of movement control switch ③ or ④.
5. Turn the starting switch ① to the “Start” position.
When the control direction has been successfully reversed, “L _ _ R” is shown in the display ⑱.

8.2.4 Pressing / resetting the emergency stop button

NOTE

Press the emergency stop button in an emergency or before any manipulation at the saw head.

Press the emergency stop button ⑧.

The emergency stop indicator ⑬ and emergency stop reset indicator ⑰ light up.

Release the emergency stop button ⑧ (turn the button).

Press the reset button ⑨.

8 Before use

8.2.5 Switching to the program mode for unfavorable electric supply conditions

If the saw frequently switches itself off and displays the error code Er33 even when running at low power (e.g. <70%), this may indicate that the conditions in the electric supply are unfavorable.

This can be resolved by switching to a special program mode.

1. When the machine is ready for operation, first press the emergency off button.
2. Turn the saw blade drive switch to “Start” and hold the switch in this position for 10 seconds until the “0” ahead of the supply voltage value shown in the display disappears.

8.3 Operating the saw

1. Use the plunge ④, advance ③ and speed regulation ⑤ controls to move the saw head along the rail to where the cut is to be started and then return all controls to the “neutral” or “0” position.
2. For rapid movement, turn the speed regulation knob ⑤ to the right beyond the pressure point ⑥ as far as it will go.
3. Switch on the cooling water ⑦.
4. Switch on the saw blade drive ① and then use the speed control ② to set the desired speed (please observe recommended speeds). Wait until the blade runs up to speed. The current speed is shown by the speed indicator ⑩.
5. Select the direction of plunge movement ④ and advance speed ⑤ and then bring the blade slowly to the desired cutting depth (plunge movement). Subsequently return the direction of plunge movement ④ and speed regulator ⑤ to the “Neutral” or “0” position.
6. Set the direction of longitudinal advance ③ and the desired speed ⑤, e.g. 100%.
7. Make the initial cut at reduced power (60%).
8. At the end of the cut, turn the speed control ⑤ to the “Zero” position and switch off the longitudinal advance ③.
9. Repeat steps 4 to 6 until the desired depth is reached.
10. Once the cut has been completed or the maximum depth reached, use the plunge movement direction control ④ to lift the saw blade out of the kerf while the blade is still rotating, bringing the saw and saw arm to the 90° position.
11. Subsequently turn all switches / knobs (advance direction, advance speed, blade speed, water supply and starting switch) back the “Neutral” or “0” position and then press the emergency stop button.
12. If necessary, fit a larger diameter saw blade (max. 900 mm dia.) and repeat the procedure.

8.4 Guidelines and guide values

The initial or guide cut

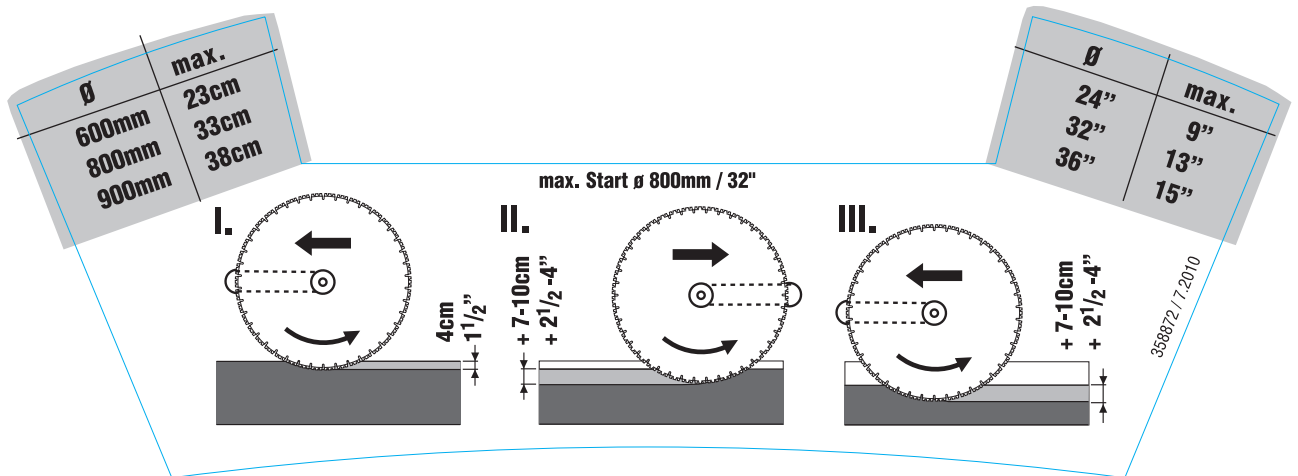

The initial cut is known as the guide cut. This cut should always be made with the saw arm in the trailing position (see illustration).

Depending on the material being cut (hard or soft concrete, masonry) the guide cut should be made to a depth of between 2 to 4 cm.

NOTE

The guide cut should always be made at reduced power (e.g. 60%). This helps to ensure that the blade stays on course, making a straight cut.

Subsequent cuts

After the guide cut has been made, sawing can continue with the saw arm trailing (pulling the blade) or leading (pushing the blade).

NOTE

It is recommended that the saw is used, where possible, with the saw arm in the trailing position.

The depth of subsequent cuts depends greatly on the material. Depths of 7 to 10 cm are recommended (see illustration). These cuts can be made at full (100%) power.

8 Before use

8.5 Remaining uncut distances

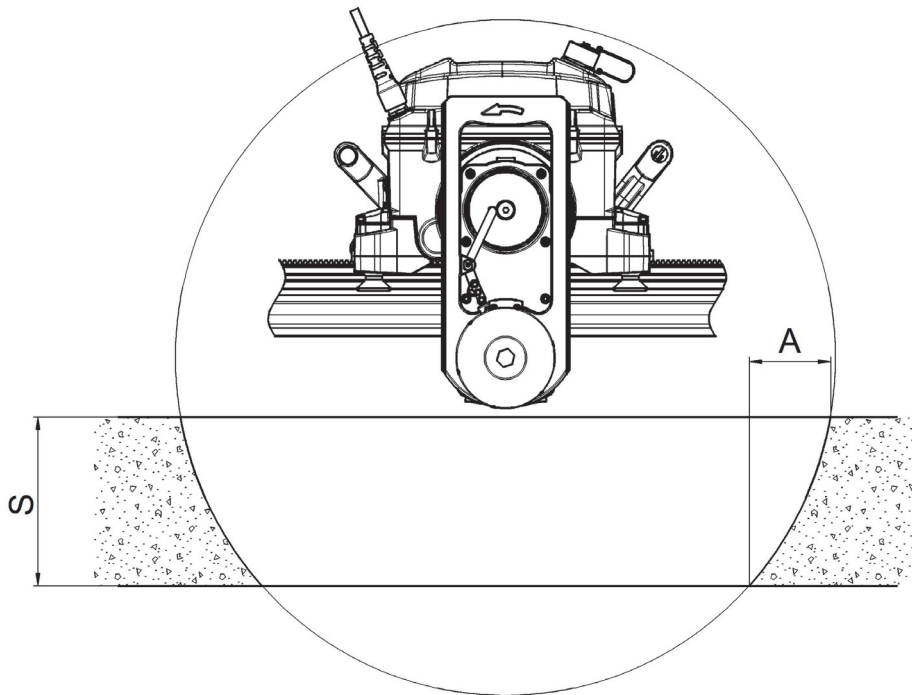

s	A		
	(Ø) 600 mm	(Ø) 800 mm	(Ø) 900 mm
20 cm	16.1 cm	10.2 cm	8.7 cm
25 cm		15.9 cm	13.2 cm
30 cm		25.1 cm	19.4 cm
35 cm			29.3 cm

8.6 Dismantling the saw system

CAUTION

Before releasing the saw head locking levers, make sure you are holding the saw head securely.

CAUTION

To avoid the possibility of damage, always switch off the saw blade drive and the advance / plunge controls before disconnecting the power cable.

CAUTION

To avoid damage when temperatures below freezing are expected, the cooling system must be fully drained by blowing out with air pressure.

8 Before use

1. Pivot the saw arm into the 90° position, switch off the machine and unplug the power cable.
2. Unplug the remote control cable and fit the protective cap to the connector.
3. Disconnect the water hose from the saw head and clean the blade guard, the saw head and the rail system.
4. Remove the blade guard and saw blade and clean these parts.
5. Remove the saw head from the rail and clean the parts.
6. Stow and secure the saw head, the rail system, the blade guard and accessories on the trolley.
7. Clean the cables and hose, roll them up and stow them on the trolley.

8.7 Blowing water out of the cooling circuit when there is a risk of frost



1. Fit the blow-out adapter to the hose on the pump.
2. Connect the pump to the water connection on the saw head.
3. Operate the pump (at least 8 full strokes) until no further water is ejected from the saw head.

9 Care and maintenance

9 Care and maintenance

9.1 Maintenance

Parts	Procedure	Daily	Weekly
Rail supports	Check the contact and clamping surfaces, clean if necessary.	●	
	Check the threads for smoothness and ease of operation, clean if necessary.		●
Rail	Check the contact and running surfaces, clean if necessary.	●	
	Check the tothing for damage and wear, replace the rail if necessary.		●
	Check the tapered sleeves, clean and lubricate with oil if necessary.	●	
Blade guard	Check and clean inner and outer surfaces, remove any slurry deposits	●	
	Check that the guide rollers are free to move, clean or replace the parts if necessary.		●
	Check the condition of the rubber tensioning straps and replace if necessary.	●	
	Check the clamping lever tension and adjust if necessary by turning the hex. head screw.	●	
Saw head	Check the locking mechanism for security of engagement, have it repaired if necessary.	●	
	Check the guide rollers for ease of operation and excessive play, have them replaced / repaired as necessary.		●
	Check the guide rollers for ease of operation and excessive play, have them replaced / repaired as necessary.	●	
	Check the cable for damage and replace it if necessary.	●	
	Check the saw blade mounting flange and mounting screw, clean or replace if necessary.	●	
	Check the saw head for oil or water leakage and have it repaired if necessary.		●
	Check the water flow and replace the mesh filter at the water supply connection if necessary.		●

9 Care and maintenance

Parts	Procedure	Daily	Weekly
Remote control unit	Check the switches and indicator lamps for correct operation. Clean the parts or have them replaced if necessary. NOTE An electric tool or machine that cannot be switched on or off reliably is dangerous and must be repaired.	●	
	Check the plug connectors for cleanliness and damage. Blow out with compressed air or have the parts replaced if necessary.	●	
	Before operation, check the casing for external damage and for signs of water ingress. Have it repaired if necessary.	●	
Water hose	Check the couplings for cleanliness, ease of operation and leakage. Clean and lubricate the couplings if necessary (lubricant spray).	●	
	Check the hose for leakage.		●
Cables / plugs	Check the plug connectors for cleanliness, damage and ease of operation. Blow out with compressed air or have the parts replaced if necessary.	●	
	Check the cables for damage and replace them if necessary.	●	
Transport trolley	Check the tyre pressures (2.1 bar or 30 PSI).		●
Tool set	Check for completeness.		●

9.2 Cleaning

CAUTION

Do not use high-pressure water jet cleaning systems to clean the saw head, remote control unit or cables. Water finding its way into these parts may cause malfunctions and damage to the equipment.

CAUTION

If a parting agent for concrete formwork or oil is applied to the equipment (to help prevent adhesion of concrete) take care to ensure that these substances and any cleaning agents used contain no solvents.

CAUTION

Substances containing solvents may attack seals and casing parts, leading to deterioration (hardness, cracking etc.).

9 Care and maintenance

1. Disconnect the system from the electric supply.
2. Clean the entire set of equipment after finishing work or before long breaks between periods of use.
3. Do not allow the dirt and slurry adhering to parts to dry out.
4. When cleaning, pay particular attention to the operating surfaces, threads, connectors, toothed sections, points of contact between moving parts, operating controls and safety or operating information plates.
5. Fit the protective caps to all plugs and connectors.
6. Clean the remote control unit and cable with a damp cloth.
7. Use a medium-hard brush and water to clean the saw head, rails, blade guard system and transport trolley.

9.3 Adjusting the guide rollers

In the event of play at the guide rollers, they can be adjusted as follows:



1. Mount and secure the saw on the rail.
2. Release the guide roller locking screw.



3. Adjust the eccentric pin in the roller axle, applying only very light pressure, until the roller comes into contact with the guide rail.

4. Re-tighten the guide roller locking screw.
NOTE The roller must remain free to rotate.
5. Repeat the procedure with the second roller.

9.4 Repairs

CAUTION

The machine may be operated, serviced and repaired only by authorized personnel who have been trained by Hilti. This personnel must be informed of any special hazards that may be encountered.

CAUTION

Repairs to electrical components may be carried out only by trained electrical specialists.

CAUTION

NEVER open the cover on the machine's casing while on a construction site.

9.5 Statutory requirements

The electrical and mechanical safety of the saw system and its accessories such as electric extension cables must be checked at the specified intervals in accordance with national regulations.

Following the provisions of EN 60204-1, in EU countries it is recommended that the checks listed below are carried out annually:

- Measurement of earth/ground conductor resistance (max. 0.3 ohms).
- Instead of the insulation resistance test in accordance with EN 60204-1, leakage current during operation should be measured, as this provides a very quick indication of a possible insulation fault.
- Measurement of earth/ground conductor current (max. 3.5 mA during operation, with the machine located on an insulated surface).
- Functional and visual check of the emergency stop switch, operating controls, indicator lamps, seals, cables, blade guard and support system in order to detect faults that could present a hazard.

9.6 Service intervals

We recommend that the system is checked at a Hilti service center after every 200 operating hours. This will ensure that the equipment is ready for use when required and help avoid high repair costs.

NOTE





The service indicator on the remote control unit lights when servicing is necessary.

10 Troubleshooting

10 Troubleshooting

10.1 The meaning of error codes and the measures to be taken to remedy faults









The electric wall saw is quipped with a fault diagnosis and error display system that allows the operator to localize faults and, as far as possible, to remedy these without assistance. Should it prove impossible to remedy the fault yourself, you can assist Hilti Service by describing the fault as precisely as possible and by stating the error code displayed by the remote control unit.

Message displayed	Code	Fault	Possible cause	Remedy
 Symbol blinks		The saw blade drive can't be switched on.	One or more control knobs or switches not in the "0" or neutral position.	Return all knobs and switches to the "0" or neutral position and restart.
 Symbol lights		The machine can't be switched on.	Emergency stop button is in the pressed-in position.	Release the button and press reset. Have the fault repaired by Hilti Service.
 Symbol lights		Not a fault.	Service interval exceeded.	Bring the saw head to Hilti Service.
 Symbol lights		The machine can't be switched on.	Emergency off reset button not pressed.	Press reset button / restart.
The display remains blank		No display on remote control unit.	Electric supply not connected or faulty.	Check the electric supply. Check the plug connectors. Return the remote control and saw head to Hilti Service.
Only error code displayed	Er00	The machine doesn't function.	Wrong remote control unit or machine identification fault.	Check compatibility and replace remote control with compatible type. Return the remote control and saw head to Hilti Service.









10 Troubleshooting

Message displayed	Code	Fault	Possible cause	Remedy
Only error code displayed	Er01 Er02	The machine doesn't function.	Communication problem between remote control unit and saw head.	Check the plug connectors and cable. Return the remote control and saw head to Hilti Service.
Only error code displayed	Er04 Er05 Er06 Er07	The machine doesn't function correctly.	Fault in the remote control electronics.	Replace the remote control unit. Return the remote control unit to Hilti Service.
Only error code displayed	Er30	The machine has switched itself off.	Slip clutch activated as a result of how the saw is being used (e.g. blade jammed).	Observe the guidelines for use of the saw. Return the saw head to Hilti Service.
Only error code displayed	Er33	The machine has switched itself off.	Safety cut-out due to brief overcurrent at the saw motor (overload or short circuit), e.g. blade stalled or saw overloaded for a short time.	Restart. Observe the application guidelines. Switch to program mode for unfavorable electric supply conditions (see section 8.2.5.). Return the saw head to Hilti Service.
Only error code displayed	Er35	The machine has switched itself off.	High current in the electronics over a long period.	Observe the application guidelines. Return the saw head to Hilti Service.
Only error code displayed	Er40	The machine has switched itself off.	Electric supply voltage too high.	Check the electric supply.
Only error code displayed	Er42	The machine has switched itself off.	Voltage in the electronics is too high.	Return the saw head to Hilti Service.
 Symbol blinks	Er44	The machine can't be switched on or switches itself off.	Electric supply phase(s) missing, voltage is too low.	Check electric supply fuses. Return the saw head to Hilti Service.
 Symbol blinks	Sr45	Warning: inadequate electric supply	Voltage in the electronics too low.	Check and improve the electric supply voltage.





10 Troubleshooting

Message displayed	Code	Fault	Possible cause	Remedy
 Symbol blinks	Sr46	Warning: inadequate electric supply	Phase voltage missing or too low.	Check phase voltage, correct any faults in the electric supply.
 Symbol lights	Er50	The machine has switched itself off due to overheating.	Saw advance motor temperature is too high. Cooling water insufficient or too warm.	Leave to cool with water flowing / re-start. Return the saw head to Hilti Service.
 Symbol lights	Er52	The machine has switched itself off due to overheating.	Saw advance motor temperature is too high. Cooling water insufficient or too warm.	Leave to cool with water flowing / re-start. Return the saw head to Hilti Service.
 Symbol lights	Er53	The machine has switched itself off due to overheating.	Saw motor temperature too high. Cooling water insufficient or too warm.	Leave to cool with water flowing / re-start. Return the saw head to Hilti Service.
 Symbol lights	Er54	The machine has switched itself off due to overheating.	Temperature too high in electronics enclosure. Cooling water insufficient or too warm.	Leave to cool with water flowing / re-start. Return the saw head to Hilti Service.
 Symbol lights	Er55	The machine has switched itself off due to overheating.	Machine interior temperature sensor fault.	Return the saw head to Hilti Service.
 Symbol lights	Er56	The machine has switched itself off due to overheating.	Saw motor temperature too high.	Leave to cool with water flowing / re-start. Return the saw head to Hilti Service.
 Symbol lights	Er57 Er58	The machine has switched itself off due to overheating.	Electronics temperature too high.	Leave to cool with water flowing / re-start. Return the saw head to Hilti Service.
 Symbol blinks	Sr60	Warning 1 before cut-out due to temperature	Saw motor temperature is high.	Improve the cooling. Observe the application guidelines. Return the saw head to Hilti Service.

10 Troubleshooting

Message displayed	Code	Fault	Possible cause	Remedy
 Symbol blinks	Sr61	Warning 2 before cut-out due to temperature	Saw motor temperature is high.	Improve the cooling. Observe the application guidelines. Return the saw head to Hilti Service.
 Symbol lights	Er62	The machine has switched itself off due to overheating.	Main motor temperature sensor fault.	Return the saw head to Hilti Service.
 Symbol blinks	Sr63	Warning 1 before cut-out due to temperature	Power module temperature too high.	Improve the cooling. Observe the application guidelines. Return the saw head to Hilti Service.
 Symbol blinks	Sr64	Warning 2 before cut-out due to temperature	Power module temperature too high.	Improve the cooling. Observe the application guidelines. Return the saw head to Hilti Service.
 Symbol lights	Er65	The machine has switched itself off.	Power unit temperature sensor fault.	Return the saw head to Hilti Service.
 Symbol blinks	Sr66	Warning 1 before cut-out due to temperature	Electronics temperature too high.	Improve the cooling. Observe the application guidelines. Return the saw head to Hilti Service.
 Symbol blinks	Sr67	Warning 2 before cut-out due to temperature	Electronics temperature too high.	Improve the cooling. Observe the application guidelines. Return the saw head to Hilti Service.
 Symbol blinks	Sr68	Warning 1 before cut-out due to temperature	Arm pivot motor temperature is high.	Improve the cooling. Observe the application guidelines. Return the saw head to Hilti Service.
 Symbol blinks	Sr69	Warning 2 before cut-out due to temperature	Arm pivot motor temperature is high.	Improve the cooling. Observe the application guidelines. Return the saw head to Hilti Service.

10 Troubleshooting

Message displayed	Code	Fault	Possible cause	Remedy
Only error code displayed	Sr70	Pulsed operation of the arm pivot motor.	Arm pivot motor stalled, lateral friction too high, blade segments are polished.	Remove obstruction / change pivot direction. Replace the saw blade. Observe the application guidelines.
 Symbol lights	Er71	The machine has switched itself off.	Arm pivot motor temperature sensor fault.	Return the saw head to Hilti Service.
 Symbol blinks	Sr72	Warning 1 before cut-out due to temperature	Saw advance motor temperature is high.	Improve the cooling. Observe the application guidelines. Return the saw head to Hilti Service.
 Symbol blinks	Sr73	Warning 2 before cut-out due to temperature	Saw advance motor temperature is high.	Improve the cooling. Observe the application guidelines. Return the saw head to Hilti Service.
Only error code displayed	Sr74	Pulsed operation of the saw advance motor.	Saw advance motor stalled, lateral friction too high, blade segments polished, end-stop reached, obstruction preventing movement along the rail.	Remove obstruction / change sawing direction. Replace the saw blade. Observe the application guidelines.
 Symbol lights	Er75	The machine has switched itself off.	Saw advance motor temperature sensor fault.	Return the saw head to Hilti Service.
Only error code displayed	Er76	The machine has switched itself off.	Overvoltage in electric supply to the saw advance / arm pivot motor.	Return the saw head to Hilti Service.
Only error code displayed	Er80	The machine has switched itself off.	Safety monitoring system triggered.	Return the saw head to Hilti Service.
Only error code displayed	Er81	The machine has switched itself off.	Memory fault, data could not be loaded.	Restart. Return the saw head to Hilti Service.

10 Troubleshooting

Message displayed	Code	Fault	Possible cause	Remedy
Only error code displayed	Er82	The machine has switched itself off.	Memory fault.	Restart. Return the saw head to Hilti Service.
Only error code displayed	Er83	The machine has switched itself off.	Software error.	Restart. Return the saw head to Hilti Service.
Only error code displayed	Er84	The machine has switched itself off.	Malfunction in the electronics overcurrent cut-out system.	Restart. Return the saw head to Hilti Service.
Only error code displayed	Er85	The machine has switched itself off.	Short circuit in the arm pivot motor.	Return the saw head to Hilti Service.
Only error code displayed	Er86	The machine has switched itself off.	Short circuit in the saw advance motor.	Return the saw head to Hilti Service.
Only error code displayed	Er92	The machine has switched itself off.	Communication malfunction between saw head and remote control unit.	Restart. Return the saw head to Hilti Service.
Only error code displayed	Er93	The machine has switched itself off.	Speed monitoring system fault.	Return the saw head to Hilti Service.
Only error code displayed	Er94	The machine has switched itself off.	Faulty connection between saw head and remote control unit.	Restart. Return the saw head to Hilti Service.
Only error code displayed	Er95	The machine has switched itself off.	Electric supply to the saw advance or arm pivot motor is overloaded.	Restart. Return the saw head to Hilti Service.
Only error code displayed	Er96	The machine has switched itself off.	Electric supply to the remote control unit is overloaded.	Restart. Return the saw head to Hilti Service.
Only error code displayed	Er97	The machine has switched itself off.	Water valve overload or short circuit.	Restart. Return the saw head to Hilti Service.
Only error code displayed	Er98	The machine can't be switched on.	Fault in the electronics.	Return the saw head to Hilti Service.

10 Troubleshooting

10.2 Causes of faults with no error code and how these faults can be remedied

Fault	Possible cause	Remedy
Blade wanders off course	Inadequate blade tension	Check the tension / replace the blade.
	Saw blade segments have lost cutting ability	Check the specification / replace the blade.
	No guide cut made or the guide cut was not straight	Adhere to the guidelines.
	Play at the guide rollers	Check play, re-adjust the rollers, replace the rollers or rails.
	Rail fastenings are loose	Check and improve the fastenings.
	Rail distorts (twists)	Install additional rail supports.
Low sawing performance	Unsuitable blade specification	Check the specification / change to suitable specification if possible.
	Depth of cut is set too deep.	Check depth of cut / reduce if possible.
	Power setting too low	Check the setting / increase if possible.
	Drop in performance due to blade wandering off course	See "Blade wanders off course".
	Drop in performance due to high reinforcement content	Check reinforcement content / change position of cut if possible
	Saw blade speed too high or too low	Check the speed / increase or reduce if possible.

11 Disposal



Most of the materials from which Hilti machines or appliances are manufactured can be recycled. The materials must be correctly separated before they can be recycled. In many countries, Hilti has already made arrangements for taking back old machines and appliances for recycling. Ask Hilti customer service or your Hilti representative for further information.



For EC countries only

Disposal of electric appliances together with household waste is not permissible.

In observance of the European Directive on waste electrical and electronic equipment and its implementation in accordance with national law, electrical appliances that have reached the end of their life must be collected separately and returned to an environmentally compatible recycling facility.

Disposal of drilling and sawing slurry

NOTE

With regard to environmental aspects, allowing drilling or sawing slurry to flow directly into rivers, lakes or the sewerage system without suitable pre-treatment is problematical.

In addition to the following recommended pre-treatment procedures, the applicable national regulations must be observed when disposing of drilling or sawing slurry. Ask the applicable local authorities for further information.

We recommend the following pre-treatment:

1. Collect the drilling or sawing slurry (e.g. using a suitable industrial vacuum cleaner).
2. The fine content of the drilling or sawing slurry should be separated from the water by allowing it to settle (e.g. leave it standing for some time or add a coagulation agent).
3. Solid material from the drilling or sawing slurry should be deposited at a construction waste disposal site.
4. Water from the drilling and sawing slurry should be neutralized (e.g. by adding a large quantity of water or other neutralization agents) before it is allowed to flow into the sewerage system.

12 Manufacturer's warranty

12 Manufacturer's warranty

Hilti warrants that the tool supplied is free of defects in material and workmanship. This warranty is valid so long as the tool is operated and handled correctly, cleaned and serviced properly and in accordance with the Hilti Operating Instructions, and the technical system is maintained. This means that only original Hilti consumables, components and spare parts may be used in the tool.

This warranty provides the free-of-charge repair or replacement of defective parts only over the entire lifespan of the tool. Parts requiring repair or replacement as a result of normal wear and tear are not covered by this warranty.

Additional claims are excluded, unless stringent national rules prohibit such exclusion. In particular, Hilti is not obligated for direct, indirect, incidental or consequential damages, losses or expenses in connection with, or by reason of, the use of, or inability to use the tool for any purpose. Implied warranties of merchantability or fitness for a particular purpose are specifically excluded.

For repair or replacement, send the tool or related parts immediately upon discovery of the defect to the address of the local Hilti marketing organization provided.

This constitutes Hilti's entire obligation with regard to warranty and supersedes all prior or contemporaneous comments and oral or written agreements concerning warranties.

13 EC declaration of conformity (original)

13 EC declaration of conformity (original)

Designation:	Electric wall saw
Type:	DST 10-E
Generation:	01
Serial number:	10001 - 99999
Year of design:	2010

We declare, on our sole responsibility, that this product complies with the following directives and standards: 2006/42/EC, 2004/108/EC, 2011/65/EU, EN 15027, EN 60204-1, EN ISO 12100.

This equipment complies with the applicable standard provided that the short-circuit power S_{SC} at the interface point between the user's supply and the public supply network is greater than or equal to 3.2 MVA. It is the responsibility of the installer or user of the equipment to ensure, by consultation with the supply network operator if necessary, that the equipment is connected only to a supply with a short-circuit power S_{SC} of greater than or equal to 3.2 MVA.

Hilti Corporation, Feldkircherstrasse 100, FL-9494 Schaan



Paolo Luccini
Head of BA Quality and Process Management
Business Area Electric Tools & Accessories
01/2012



Johannes Wilfried Huber
Senior Vice President
Business Unit Diamond
01/2012

Technical documentation filed at:

Hilti Entwicklungsgesellschaft mbH
Zulassung Elektrowerkzeuge
Hiltistrasse 6
86916 Kaufering
Deutschland



Hilti Corporation

LI-9494 Schaan

Tel.: +423/234 21 11

Fax: +423/234 29 65

www.hilti.com

