



**HILTI HIT-RE 500 V4
INJECTION MORTAR
ETA-20/0541 (09.06.2023)**



English	2-69
Deutsch	70-137
Français	138-205
Polski	206-273

European Technical Assessment

**ETA-20/0541
of 09/06/2023**

English translation prepared by CSTB - Original version in French language

General Part

Technical Assessment Body issuing the European Technical Assessment:

Centre Scientifique et Technique du Bâtiment (CSTB)

Trade name:

Injection system Hilti HIT-RE 500 V4

Product family:

Bonded fastener with threaded rods, rebar, internally threaded sleeve HIS-(R)N and Hilti Tension anchor HZA(-R) for use in concrete for a working life of 50 and 100 years

Manufacturer:

Hilti Corporation
Feldkircherstrasse 100
FL-9494 Schaan
Principality of Liechtenstein

Manufacturing plants:

Hilti Plant

This European Technical
Assessment contains:

68 pages including 64 pages of annexes which form an integral part of this assessment

This European Technical
Assessment is issued in
accordance with Regulation (EU)
No 305/2011, on the basis of:

EAD 330499-02-0601 version September 2022

This Assessment replaces:

ETA-20/0541 dated 04/09/2021

Corrigendum

The European Technical Assessment is issued by the Technical Assessment Body in its official language. Translations of this European Technical Assessment in other languages shall fully correspond to the original issued document and shall be identified as such. Communication of this European Technical Assessment, including transmission by electronic means, shall be in full. However, partial reproduction may only be made with the written consent of the issuing Technical Assessment Body. Any partial reproduction shall be identified as such. This European Technical Assessment may be withdrawn by the issuing Technical Assessment Body, in particular pursuant to information by the Commission in accordance with Article 25(3) of Regulation (EU) No 305/2011.

Specific Part

1 Technical description of the product

The Injection system Hilti HIT-RE 500 V4 is a bonded fastener consisting of a foil pack with injection mortar Hilti HIT-RE 500 V4 and a steel element.

These steel elements are:

- a threaded rod Hilti HAS, HAS-U, Hilti HIT-V, Hilti meter rod AM 8.8 or a commercial threaded rod with washer and hexagon nut in the range of M8 to M30 and 3/8 in. to 1 1/4 in.
- a reinforcing bar (rebar) in the range of $\phi 8$ to $\phi 32$.
- a Hilti Tension anchor HZA in the range of M12 to M27 or HZA-R in the range of M12 to M24.
- an internal threaded sleeve HIS-(R)N in the range M8 to M20 and 3/8 in. to 3/4 in.

The steel element is placed into a drilled hole filled with injection mortar and is anchored via the bond between steel element, injection mortar and concrete.

The illustration and the description of the product are given in Annexes A.

2 Specification of the intended use

The performances given in Section 3 are only valid if the fastener is used in compliance with the specifications and conditions given in Annexes B.

The provisions made in this European technical assessment are based on an assumed working life of the fastener of 50 and 100 years. The indications given on the working life cannot be interpreted as a guarantee given by the producer, but are to be regarded only as a means for choosing the right products in relation to the expected economically reasonable working life of the works.

3 Performance of the product

3.1 Mechanical resistance and stability (BWR 1)

Essential characteristic	Performance
Characteristic resistance for static and quasi static loads, Displacements	See Annexes C1 to C28
Characteristic resistance for seismic performance category C1	See Annexes C29 to C35
Characteristic resistance for seismic performance category C2, Displacements	See Annexes C36 to C38

3.2 Safety in case of fire (BWR 2)

Essential characteristic	Performance
Reaction to fire	Fasteners satisfy requirements for Class A1
Resistance to fire	See Annexes C39 to C42

3.3 Hygiene, health and the environment (BWR 3)

Regarding dangerous substances contained in this European technical approval, there may be requirements applicable to the products falling within its scope (e.g., transposed European legislation and national laws, regulations and administrative provisions). In order to meet the provisions of the Construction Products Directive, these requirements need also to be complied with, when and where they apply.

3.4 Safety in use (BWR 4)

For Basic requirement Safety in use the same criteria are valid as for Basic Requirement Mechanical resistance and stability.

3.5 Protection against noise (BWR 5)

Not relevant.

3.6 Energy economy and heat retention (BWR 6)

Not relevant.

3.7 Sustainable use of natural resources (BWR 7)

For the sustainable use of natural resources no performance was determined for this product.

3.8 General aspects relating to fitness for use

Durability and Serviceability are only ensured if the specifications of intended use according to Annex B1 are kept.

4 Assessment and verification of constancy of performance (AVCP)

According to the Decision 96/582/EC of the European Commission¹, as amended, the system of assessment and verification of constancy of performance (see Annex V to Regulation (EU) No 305/2011) given in the following table apply.

Product	Intended use	Level or class	System
Bonded fasteners for use in concrete	For fixing and/or supporting to concrete, structural elements (which contributes to the stability of the works) or heavy units	-	1

5 Technical details necessary for the implementation of the AVCP system, as planned in the relevant EAD

Technical details necessary for the implementation of the Assessment and verification of constancy of performance (AVCP) system are laid down in the control plan deposited at Centre Scientifique et Technique du Bâtiment.

The following standards are referred to in this European Technical Assessment:

- EN 1992-1-1:2004 + AC:2010 Eurocode 2: Design of concrete structures - Part 1-1: General rules and rules for buildings
- EN 1992-1-2:2004 + AC:2008 Eurocode 2: Design of concrete structures - Part 1-2: General rules – Structural fire design
- EN 1992-4:2018 Eurocode 2: Design of concrete structures – Part 4: Design of fastenings for use in concrete
- EN 1993-1-4:2006 + A1:2015 Eurocode 3: Design of steel structures, Part 1-4: General rules – Supplementary rules for stainless steels
- EN 1998-1:2004 + A1:2013 Eurocode 8: Design of structures for earthquake resistance - Part 1: General rules, seismic actions and rules for buildings
- EN 10088-1:2014 Stainless steels – Part 1: List of stainless steels
- EN 206:2013 + A2:2021 Concrete: Specification, performance, production and conformity

¹ Official Journal of the European Communities L 254 of 08.10.1996.

The control plan including confidential informations is not included in the published part of this ETA.
The manufacturer shall, on the basis of a contract, involve a notified body approved in the field of fasteners for issuing the certificate of conformity CE based on the control plan.
The Notified Body shall visit the factory at least twice a year for surveillance of the manufacturer.

The original French version is signed by:

Anca Cronopol
Head of the Structure, Masonry, Partition Division

Installed condition

Figure A1: Threaded rod, HAS ..., HAS-U..., HAS-..., HIT-V-..., AM...

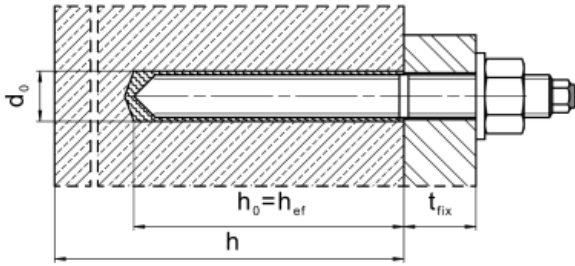

Figure A2: Threaded rod, HAS ..., HAS-U-..., HIT-V-..., AM..., with Hilti Filling Set...

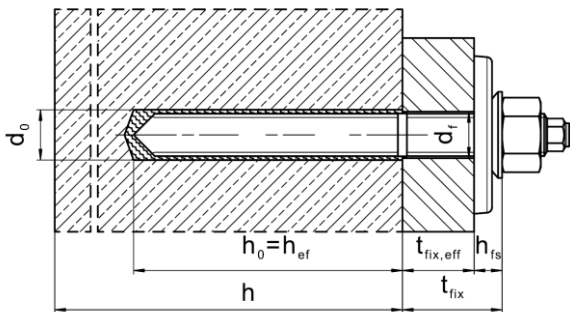

Figure A3: Internally threaded sleeve HIS-(R)N

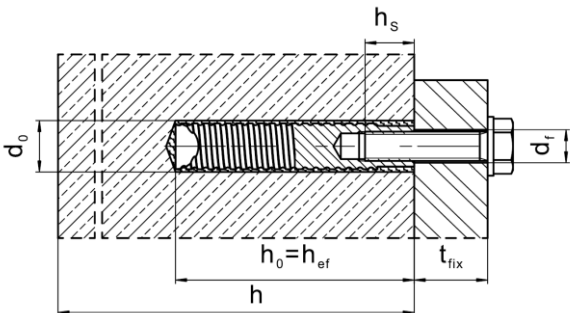
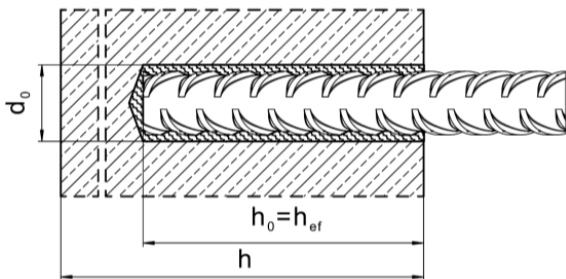

Figure A4: Reinforcing bar (rebar)



Injection system Hilti HIT-RE 500 V4

Product description
 Installed condition

Annex A1

Product description: Injection mortar and steel elements

Injection mortar Hilti HIT-RE 500 V4: epoxy resin system with aggregate

330 ml, 500 ml and 1400 ml

Marking:
 HILTI HIT
 Product name
 Production time and line
 Expiry date mm/yyyy



Product name: "Hilti HIT-RE 500 V4"

Static mixer Hilti HIT-RE-M



Steel elements

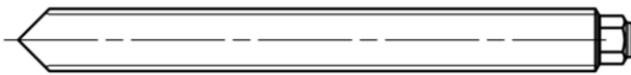

Marking

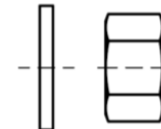

washer nut

HAS-U...: M8 to M30

Marking: Steel grade number and length identification number

- 5 = HAS-U 5.8, 5.8 HDG
- 8 = HAS-U 8.8, 8.8. HDG
- 1 = HAS-U A4
- 2 = HAS-U HCR

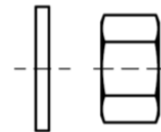
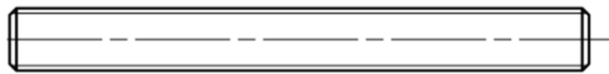

washer nut

HAS ...: M8 to M30

HAS Color code marking:

- 5.8 = RAL 5010 (blue)
- 8.8 = RAL 1023 (yellow)
- A4 = RAL 3000 (red)

AM ... 8.8: (HDG) M8 to M30

Injection system Hilti HIT-RE 500 V4

Product description
 Steel elements

Annex A2

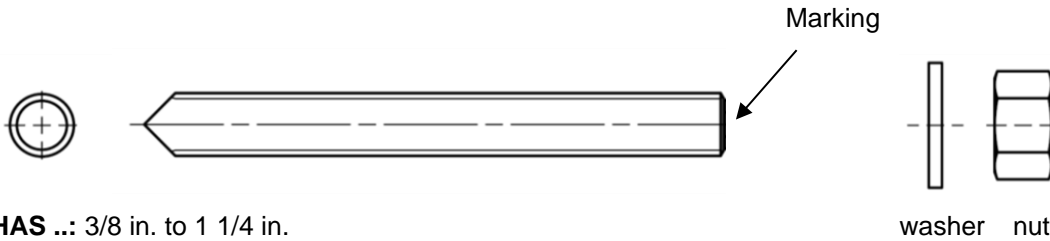

HAS ..: 3/8 in. to 1 1/4 in.

Marking: Steel grade and element length [in]

- V = HAS-V-36 (HDG)
- E = HAS-E-55
- B = HAS-B-105 (HDG)
- R1 = HAS-R 304
- R2 = HAS-R 316

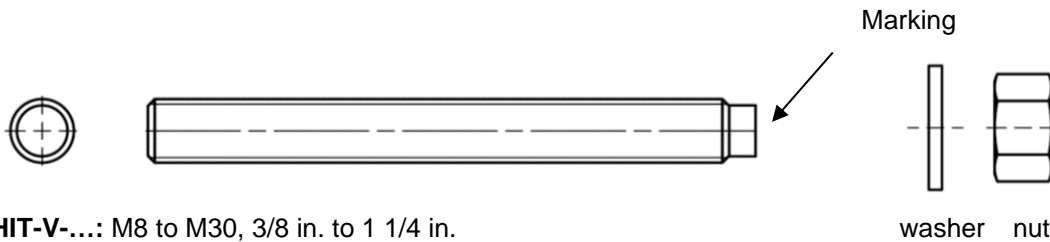

HIT-V-...: M8 to M30, 3/8 in. to 1 1/4 in.

Marking: e.g.,

- 5.8 - l = HIT-V-5.8 M...x l
- 5.8F - l = HIT-V-5.8F M...x l
- 8.8 - l = HIT-V-8.8 M...x l
- 8.8F - l = HIT-V-8.8F M...x l
- R - l = HIT-V-R M...x l
- HCR - l = HIT-V-HCR M...x l

Commercial standard threaded rod: M8 to M30, 3/8 in. to 1 1/4 in.

- Materials and mechanical properties according to Table A2.
- Inspection certificate 3.1 according to EN 10204. The document shall be stored.
- Marking of embedment depth.

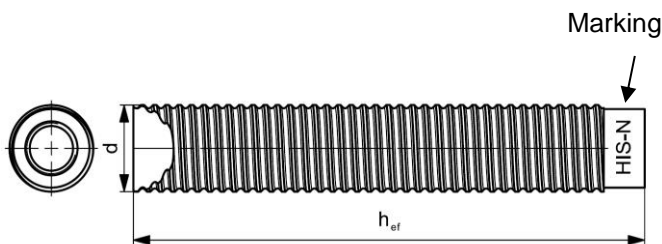

Internally threaded sleeve HIS-(R)N: M8 to M20, 3/8 in. to 3/4 in.

Marking:

Identifying mark - HILTI and embossing "HIS-N" (for zinc coated steel) or embossing "HIS-RN" (for stainless steel)

Injection system Hilti HIT-RE 500 V4

Product description
 Steel elements

Annex A3

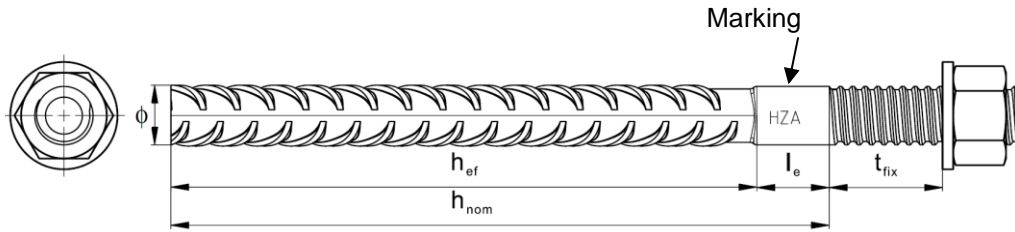

Hilti Tension anchor HZA: M12 to M27
Hilti Tension anchor HZA-R: M12 to M24

Marking:
 embossing "HZA-R" M .. / t_{fix}

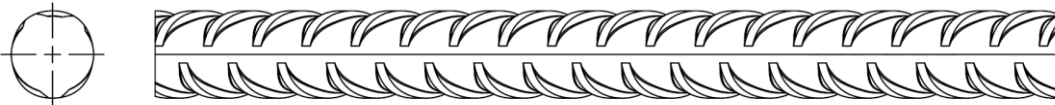

Reinforcing bar (rebar): $\phi 8$ to $\phi 32$

- Materials and mechanical properties according to Table A2.
- Dimensions according to Annex B
- Minimum value of related rib area $f_{R,min}$ according to EN 1992-1-1:2004+AC:2010
- Rib height of the bar h_{rib} shall be in the range $0,05 \cdot \phi \leq h_{rib} \leq 0,07 \cdot \phi$
 (ϕ : nominal diameter of the bar; h_{rib} : rib height of the bar)

Hilti Filling Set to fill the annular gap between steel element and fixture

Sealing washer

Spherical washer

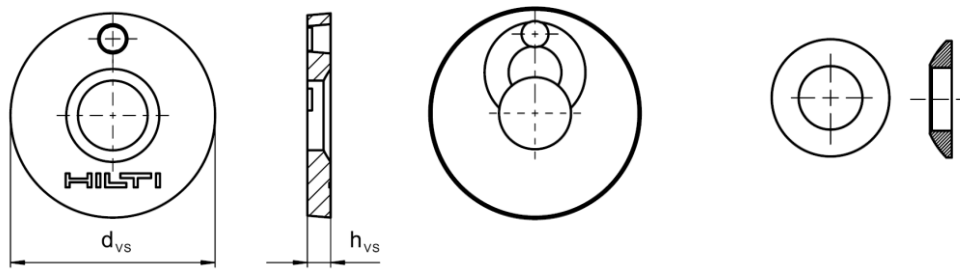

Table A1: Geometry of Hilti Filling Set

Hilti Filling Set		M8	M10	M12	M16	M20	M24
Diameter of sealing washer	d_{vs} [mm]	38	42	44	52	60	70
Thickness of sealing washer	h_{vs} [mm]	5			6		
Thickness of Hilti Filling Set	h_{fs} [mm]	8	9	10	11	13	15

Injection system Hilti HIT-RE 500 V4

Product description
 Steel elements

Annex A4

Table A2: Materials

Designation	Material
Reinforcing bars (rebars)	
Rebar EN 1992-1-1:2004 and AC:2010, Annex C	Bars and de-coiled rods class B or C with f_{yk} and k according to NDP or NCL of EN 1992-1-1/NA:2013 $f_{uk} = f_{tk} = k \cdot f_{yk}$
Steel elements made of zinc coated steel	
HAS 5.8 (HDG), HAS-U 5.8 (HDG), HIT-V-5.8 (F), Threaded rod 5.8	Strength class 5.8, $f_{uk} = 500 \text{ N/mm}^2$, $f_{yk} = 400 \text{ N/mm}^2$ Elongation at fracture ($l_0 = 5d$) > 8% ductile Electroplated zinc coated $\geq 5 \mu\text{m}$, (F) or (HDG) hot dip galvanized $\geq 50 \mu\text{m}$
Threaded rod 6.8	Strength class 6.8, $f_{uk} = 600 \text{ N/mm}^2$, $f_{yk} = 480 \text{ N/mm}^2$ Elongation at fracture ($l_0 = 5d$) > 8% ductile Electroplated zinc coated $\geq 5 \mu\text{m}$, (F) or (HDG) hot dip galvanized $\geq 50 \mu\text{m}$
HAS 8.8 (HDG), HAS-U-8.8 (HDG), HIT-V-8.8 (F), AM 8.8 Threaded rod 8.8	Strength class 8.8, $f_{uk} = 800 \text{ N/mm}^2$, $f_{yk} = 640 \text{ N/mm}^2$ Elongation at fracture ($l_0 = 5d$) > 12% ductile Electroplated zinc coated $\geq 5 \mu\text{m}$, (F) or (HDG) hot dip galvanized $\geq 50 \mu\text{m}$
Hilti Tension anchor HZA	Round steel with threaded part: electroplated zinc coated $\geq 5 \mu\text{m}$ Rebar: bars class B according to NDP or NCL of EN 1992-1-1/NA
Internally threaded sleeve HIS-N	Electroplated zinc coated $\geq 5 \mu\text{m}$
Threaded rod, HIT-V	ASTM A 307 Grade A, $f_{uk} = 414 \text{ N/mm}^2$, $f_{yk} = 259 \text{ N/mm}^2$ Elongation at fracture ($l_0 = 5d$) > 8% ductile Electroplated zinc coated $\geq 5 \mu\text{m}$
Threaded rod, HAS-V-36 (HDG)	ASTM F1554, Grade 36, $f_{uk} = 400 \text{ N/mm}^2$, $f_{yk} = 248 \text{ N/mm}^2$ Elongation at fracture ($l_0 = 5d$) > 23% ductile Electroplated zinc coated $\geq 5 \mu\text{m}$, (HDG) hot dip galvanized $\geq 53 \mu\text{m}$
Threaded rod, HAS-E-55	ASTM F1554, Grade 55, $f_{uk} = 517 \text{ N/mm}^2$, $f_{yk} = 379 \text{ N/mm}^2$ Elongation at fracture ($l_0 = 5d$) > 21% ductile Electroplated zinc coated $\geq 5 \mu\text{m}$
Threaded rod, HAS-B-105 (HDG)	ASTM F1554, Grade 105, $f_{uk} = 862 \text{ N/mm}^2$, $f_{yk} = 724 \text{ N/mm}^2$ Elongation at fracture ($l_0 = 5d$) > 15% ductile Electroplated zinc coated $\geq 5 \mu\text{m}$, (HDG) hot dip galvanized $\geq 53 \mu\text{m}$
Washer	Electroplated zinc coated $\geq 5 \mu\text{m}$, hot dip galvanized $\geq 50 \mu\text{m}$
Nut	Nominal strength class equal or higher to nominal strength class of rod Electroplated zinc coated $\geq 5 \mu\text{m}$, hot dip galvanized $\geq 50 \mu\text{m}$
Hilti Filling Set (F)	Filling washer: Electroplated zinc coated $\geq 5 \mu\text{m}$, (F) hot dip galvanized $\geq 50 \mu\text{m}$ Spherical washer: Electroplated zinc coated $\geq 5 \mu\text{m}$, (F) hot dip galvanized $\geq 50 \mu\text{m}$ Lock nut: Electroplated zinc coated $\geq 5 \mu\text{m}$, (F) Electroplated zinc-nickel coated $6 \mu\text{m}$

Injection system Hilti HIT-RE 500 V4

Product description
Materials

Annex A5

Table A2: continued

Steel elements made of stainless steel	
Corrosion resistance class (CRC II) acc. to EN 1993-1-4	
Threaded rod	For ≤ M24: strength class 70, $f_{uk} = 700 \text{ N/mm}^2$, $f_{yk} = 450 \text{ N/mm}^2$ For > M24: strength class 50, $f_{uk} = 500 \text{ N/mm}^2$, $f_{yk} = 210 \text{ N/mm}^2$ Elongation at fracture ($l_0 = 5d$) > 12% ductile Stainless steel 1.4301, 1.4307, 1.4311, 1.4541, 1.4306, 1.4567 EN 10088-1
Washer	Stainless steel 1.4301, 1.4307, 1.4311, 1.4541, 1.4306, 1.4567 EN 10088-1
Nut	For ≤ M24: strength class 70, $f_{uk} = 700 \text{ N/mm}^2$, $f_{yk} = 450 \text{ N/mm}^2$ For > M24: strength class 50, $f_{uk} = 500 \text{ N/mm}^2$, $f_{yk} = 210 \text{ N/mm}^2$ Stainless steel 1.4301, 1.4307, 1.4311, 1.4541, 1.4306, 1.4567 according to EN 10088-1: 2014
Threaded rod, HAS-R 304	Size 3/8 in. to 5/8 in.: ASTM F593 CW1, $f_{uk} = 689 \text{ N/mm}^2$, $f_{yk} = 448 \text{ N/mm}^2$ Elongation at fracture ($l_0 = 5d$) > 12% ductile Size 3/4 in. to 1 in.: ASTM F593 CW2, $f_{uk} = 586 \text{ N/mm}^2$, $f_{yk} = 310 \text{ N/mm}^2$ Elongation at fracture ($l_0 = 5d$) > 12% ductile Size > 1 in.: ASTM A193 Grade 8(M), class 1, $f_{uk} = 515 \text{ N/mm}^2$, $f_{yk} = 205 \text{ N/mm}^2$ Elongation at fracture ($l_0 = 5d$) > 12% ductile
Washer	Stainless steel ASTM F593 and ASTM A193
Nut	Nominal strength class equal or higher to nominal strength class of rod
Steel elements made of stainless steel	
Corrosion resistance class (CRC III) acc. to EN 1993-1-4	
HAS A4, HAS-U A4, HIT-V-R, Threaded rod A4	For ≤ M24: strength class 70, $f_{uk} = 700 \text{ N/mm}^2$, $f_{yk} = 450 \text{ N/mm}^2$ For > M24: strength class 50, $f_{uk} = 500 \text{ N/mm}^2$, $f_{yk} = 210 \text{ N/mm}^2$ Elongation at fracture ($l_0 = 5d$) > 12% ductile Stainless steel 1.4401, 1.4404, 1.4578, 1.4571, 1.4439, 1.4362 EN 10088-1
Hilti Tension anchor HZA-R	Round steel with threaded part: Stainless steel according to EN 10088-1:2014 Rebar: bars class B according to NDP or NCL of EN 1992-1-1/NA:2013
Internally threaded sleeve HIS-RN	Stainless steel 1.4401, 1.4571 EN 10088-1
Threaded rod, HAS-R 316	Size 3/8 in. to 5/8 in.: ASTM F593 CW1, $f_{uk} = 689 \text{ N/mm}^2$, $f_{yk} = 448 \text{ N/mm}^2$ Elongation at fracture ($l_0 = 5d$) > 12% ductile Size 3/4 in. to 1 1/4 in.: ASTM F 593 CW2, $f_{uk} = 586 \text{ N/mm}^2$, $f_{yk} = 310 \text{ N/mm}^2$ Elongation at fracture ($l_0 = 5d$) > 12% ductile
Washer	Stainless steel ASTM F593
Nut	Nominal strength class equal or higher to nominal strength class of rod
Hilti Filling Set A4	Filling washer: Stainless steel according to EN 10088-1 Spherical washer: Stainless steel according to EN 10088-1 Lock nut: Stainless steel according to EN 10088-1

Injection system Hilti HIT-RE 500 V4

Product description
 Materials

Annex A6

Table A2: continued

Steel elements made of high corrosion resistant steel	
Corrosion resistance class (CRC V) acc. to EN 1993-1-4	
HAS-U HCR, HIT-V-HCR, Threaded rod	For $\leq M20$: $f_{uk} = 800 \text{ N/mm}^2$, $f_{yk} = 640 \text{ N/mm}^2$ For $> M20$: $f_{uk} = 700 \text{ N/mm}^2$, $f_{yk} = 400 \text{ N/mm}^2$ Elongation at fracture ($l_0 = 5d$) $> 12\%$ ductile High corrosion resistant steel 1.4529, 1.4565 EN 10088-1
Washer	High corrosion resistant steel 1.4529, 1.4565 EN 10088-1
Nut	Nominal strength class equal or higher to nominal strength class of rod High corrosion resistant steel 1.4529, 1.4565 EN 10088-1

Injection system Hilti HIT-RE 500 V4

Product description
 Materials

Annex A7

Specifications of intended use

Fasteners subject to:

- Static and quasi static loading.
- Seismic performance category C1.
- Seismic performance category C2 (HAS (8.8, 8.8 HDG, A4), HAS-U (8.8, 8.8 HDG, A4, HCR), HIT-V (-8.8, -8.8F, -R, -HCR), AM (8.8, 8.8 HDG) and standard threaded rod (grade 8.8, A4, HCR)), with hammer drilling and hammer drilling with Hilti hollow drill bit TE-CD, TE-YD.
- Fire exposure: threaded rod size M8 to M30 (HAS (5.8, 5.8 HDG, 8.8, 8.8 HDG, A4-70), (HAS-U (5.8, 5.8 HDG, 8.8, 8.8 HDG, A4-70, HCR), HIT-V (5.8, 5.8F, 8.8, 8.8F ,R, HCR), 3/8 to 1 1/4 (HAS-E-55, HAS-B-105 (HDG))).

Base material:

- Compacted reinforced or unreinforced normal weight concrete without fibres according to EN 206
- Strength classes C20/25 to C50/60 according to EN 206
- Cracked and uncracked concrete.

Temperature in the base material:

- **at installation**
-5°C to +40°C for the standard variation of temperature after installation
- **in-service**
Temperature range I: -40°C to +40°C
(max. long term temperature +24°C and max. short term temperature +40°C)
Temperature range II: -40°C to +55°C
(max. long term temperature +43°C and max. short term temperature +55°C)
Temperature range III: -40°C to +75°C
(max. long term temperature +55°C and max. short term temperature +75°C)

Use conditions (Environmental conditions):

- Structures subject to dry internal conditions (all materials).
- For all other conditions according EN 1993-1-4 corresponding to corrosion resistance classes Annex A (stainless steel and high corrosion resistant steel).

Design:

- Fasteners are designed under the responsibility of an engineer experienced in fasteners and concrete work.
- Verifiable calculation notes and drawings are prepared taking account of the loads to be anchored. The position of the fastener is indicated on the design drawings (e. g. position of the fastener relative to reinforcement or to supports, etc.).
- The fasteners are designed in accordance with EN 1992-4 and EOTA Technical Report 055. Fasteners under seismic actions shall be positioned outside of critical regions (e.g., plastic hinges) of the concrete structure. Fastening in stand-off installation or with a grout layer under seismic action are not covered in this European technical assessment (ETA).
- For applications with resistance to fire exposure, the fasteners are designed in accordance with EOTA TR 082 "Design of bonded fasteners in concrete under fire conditions"

Injection system Hilti HIT-RE 500 V4

Intended use
Specifications

Annex B1

Installation:

- Use category:
 - dry or wet concrete (not in water-filled drill holes): for all drilling techniques.
 - water-filled drill holes: for hammer drilling only, for uncracked concrete only.
- Drilling technique:
 - hammer drilling,
 - hammer drilling with Hilti hollow drill bit TE-CD, TE-YD,
 - diamond coring, for uncracked concrete only,
 - diamond coring with roughening with Hilti Roughening tool TE-YRT.
- Installation direction D3: downward, horizontal and upward (e.g., overhead) installation admissible for all elements.
- Fastener installation carried out by appropriately qualified personnel and under the supervision of the person responsible for technical matters of the site.

Injection system Hilti HIT-RE 500 V4

Intended use
Specifications

Annex B2

Table B1: Installation parameters of metric threaded rod according to Annex A

Metric threaded rod according to Annex A	M8	M10	M12	M16	M20	M24	M27	M30
Diameter of element d [mm]	8	10	12	16	20	24	27	30
Nominal diameter of drill bit d_0 [mm]	10	12	14	18	22	28	30	35
Effective embedment depth and drill hole depth h_{ef} [mm]	60 to 160	60 to 200	70 to 240	80 to 320	90 to 400	96 to 480	108 to 540	120 to 600
Maximum diameter of clearance hole in the fixture d_f [mm]	9	12	14	18	22	26	30	33
Thickness of Hilti Filling Set h_{fs} [mm]	8	9	10	11	13	15	-	-
Effective fixture thickness with Hilti Filling Set $t_{fix,eff}$ [mm]	$t_{fix,eff} = t_{fix} + h_{fs}$							
Minimum thickness of concrete member h_{min} [mm]	$h_{ef} + 30$ $\geq 100 \text{ mm}$			$h_{ef} + 2 \cdot d_0$				
Maximum installation torque $\max. T_{inst}$ [Nm]	10	20	40	80	150	200	270	300
Minimum spacing s_{min} [mm]	40	50	60	75	90	115	120	140
Minimum edge distance c_{min} [mm]	40	45	45	50	55	60	75	80

Table B2: Installation parameters fractional threaded rod according to Annex A

Fractional threaded rod according to Annex A	3/8	1/2	5/8	3/4	7/8	1	1 1/4
Diameter of element d [mm]	9,5	12,7	15,9	19,1	22,2	25,4	31,8
Nominal diameter of drill bit d_0 [in.]	7/16	9/16	3/4	7/8	1	1 1/8	1 3/8
Effective cross sectional area $A_s^{1)}$ [mm ²]	50	92	146	216	298	391	625
Effective embedment depth and drill hole depth h_{ef} [mm]	60 to 191	70 to 254	79 to 318	89 to 381	89 to 445	102 to 508	127 to 635
Maximum diameter of clearance hole in the fixture d_f [mm]	11,1	14,3	17,5	20,6	23,8	28,6	34,9
Minimum thickness of concrete member h_{min} [mm]	$h_{ef} + 30$ $\geq 100 \text{ mm}$		$h_{ef} + 2 \cdot d_0$				
Maximum installation torque $\max. T_{inst}$ [Nm]	20	41	81	136	169	203	271
Minimum spacing s_{min} [mm]	45	60	80	90	105	115	140
Minimum edge distance c_{min} [mm]	45	45	50	55	60	70	80

1) Effective cross sectional area for calculation of characteristic steel resistance.

Injection system Hilti HIT-RE 500 V4

Intended use
 Installation parameters

Annex B2

Table B3: Installation parameters of internally threaded sleeve HIS-(R)N

HIS-(R)N			M8	M10	M12	M16	M20
Outer diameter of sleeve	d	[mm]	12,5	16,5	20,5	25,4	27,6
Nominal diameter of drill bit	d_0	[mm]	14	18	22	28	32
Effective embedment depth and drill hole depth	h_{ef}	[mm]	90	110	125	170	205
Maximum diameter of clearance hole in the fixture ³⁾	d_f	[mm]	9	12	14	18	22
Thickness of Hilti Filling Set	h_{fs}	[mm]	8	9	10	11	13
Effective fixture thickness with Hilti Filling Set	$t_{fix,eff}$	[mm]	$t_{fix,eff} = t_{fix} + h_{fs}$				
Minimum thickness of concrete member	h_{min}	[mm]	120	150	170	230	270
Maximum installation torque	$max. T_{inst}$	[Nm]	10	20	40	80	150
Thread engagement length min-max	h_s	[mm]	8 to 20	10 to 25	12 to 30	16 to 40	20 to 50
Minimum spacing	s_{min}	[mm]	60	75	90	115	130
Minimum edge distance	c_{min}	[mm]	40	45	55	65	90

Table B4: Installation parameters of internally threaded sleeve HIS-(R)N

HIS-(R)N, size			3/8	1/2	5/8	3/4
Outer diameter of sleeve	d	[mm]	16,5	20,5	25,4	27,6
Nominal diameter of drill bit	d_0	[in.]	11/16	7/8	1 1/8	1
Effective embedment depth and drill hole depth	h_{ef}	[mm]	110	125	170	205
Maximum diameter of clearance hole in the fixture	d_f	[mm]	11,1	14,3	17,5	20,6
Minimum thickness of concrete member	h_{min}	[mm]	150	170	230	270
Maximum installation torque	$max. T_{inst}$	[Nm]	20	41	81	136
Thread engagement length min to max	h_s	[mm]	10 to 25	12 to 30	16 to 40	20 to 50
Minimum spacing	s_{min}	[mm]	70	90	115	130
Minimum edge distance	c_{min}	[mm]	45	55	65	90

Injection system Hilti HIT-RE 500 V4

Intended use
 Installation parameters

Annex B3

Table B5: Installation parameters of Hilti Tension anchor HZA / HZA-R

HZA			M12	M16	M20	M24	M27	
HZA-R			M12	M16	M20	M24	-	
Rebar diameter	ϕ	[mm]	12	16	20	25	28	
Nominal embedment depth and drill hole depth HZA	h_0	[mm]	90 to 240	100 to 320	110 to 400	120 to 500	140 to 560	
Nominal embedment depth and drill hole depth HZA-R	h_0	[mm]	170 to 240	180 to 320	190 to 400	200 to 500	-	
Effective embedment depth HZA ($h_{ef} = h_{nom} - l_e$)	h_{ef}	[mm]	$h_{nom} - 20$					
Effective embedment depth HZA-R ($h_{ef} = h_{nom} - l_e$)	h_{ef}	[mm]	$h_{nom} - 100$					
Length of smooth shaft HZA	l_e	[mm]	20					
Length of smooth shaft HZA-R	l_e	[mm]	100					
Nominal diameter of drill bit	d_0	[mm]	16	20	25	32	35	
Maximum diameter of clearance hole in the fixture	d_f	[mm]	14	18	22	26	30	
Thickness of Hilti Filling Set	h_{fs}	[mm]	10	11	13	15	-	
Effective fixture thickness with Hilti Filling Set	$t_{fix,eff}$	[mm]	$t_{fix,eff} = t_{fix} - h_{fs}$					-
Maximum installation torque	max. T_{inst}	[Nm]	40	80	150	200	270	
Minimum thickness of concrete member	h_{min}	[mm]	$h_{nom} + 2 \cdot d_0$					
Minimum spacing	s_{min}	[mm]	65	80	100	130	140	
Minimum edge distance	c_{min}	[mm]	45	50	55	60	75	

Table B6: Installation parameters of reinforcing bar (rebar)

Reinforcing bar (rebar)			$\phi 8$	$\phi 10$	$\phi 12$	$\phi 14$	$\phi 16$	$\phi 18$	$\phi 20$	$\phi 24$	$\phi 25$	$\phi 28$	$\phi 30$	$\phi 32$
Diameter	ϕ	[mm]	8	10	12	14	16	18	20	24	25	28	30	32
Effective embedment depth and drill hole depth	h_{ef}	[mm]	60 to 160	60 to 200	70 to 240	75 to 280	80 to 320	85 to 360	90 to 400	100 to 480	100 to 500	112 to 560	120 to 600	128 to 640
Nominal diameter of drill bit	d_0	[mm]	10 ¹⁾ 12 ¹⁾	12 ¹⁾ 14 ¹⁾	14 ¹⁾ 16 ¹⁾	18	20	22	25	30 ¹⁾ 32 ¹⁾	30 ¹⁾ 32 ¹⁾	35	37	40
Minimum thickness of concrete member	h_{min}	[mm]	$h_{ef} + 30$ $\geq 100 \text{ mm}$			$h_{ef} + 2 \cdot d_0$								
Minimum spacing	s_{min}	[mm]	40	50	60	70	80	90	100	125	125	140	150	160
Minimum edge distance	c_{min}	[mm]	40	45	45	50	50	60	65	70	70	75	80	80

1) Each of the two given values can be used.

Injection system Hilti HIT-RE 500 V4

Intended use
Installation parameters

Annex B4

Table B7: Working and curing time^{1) 2)}

Temperature in the base material <i>T</i>	Maximum working time <i>t_{work}</i>	Minimum curing time <i>t_{cure}</i> ¹⁾
-5°C to -1°C	2 hours	168 hours
0°C to 4°C	2 hours	48 hours
5°C to 9°C	2 hours	24 hours
10°C to 14°C	1,5 hours	16 hours
15°C to 19°C	1 hour	12 hours
20°C to 24°C	30 min	7 hours
25°C to 29°C	20 min	6 hours
30°C to 34°C	15 min	5 hours
35°C to 39°C	12 min	4,5 hours
40°C	10 min	4 hours

¹⁾ The curing time data are valid for dry base material only. In wet base material the curing times must be doubled.











²⁾ The minimum temperature of the foil pack is +5°C.

Injection system Hilti HIT-RE 500 V4

Intended use
 Working and curing time

Annex B5

Table B8: Parameters of cleaning and setting tools

Steel elements				Drill and clean				Installation	
Metric threaded rod (Annex A)	HIS-(R)N	Rebar	HZA(-R)	Hammer drilling		Diamond coring		Brush	Piston plug
				Hollow drill bit TE-CD, TE-YD ¹⁾		Roughening tool TE-YRT			
									
Size	Size	Size	Size	d_0 [mm]	d_0 [mm]	d_0 [mm]	d_0 [mm]	HIT-RB	HIT-SZ
M8	-	$\phi 8$	-	10	10	10	-	10	-
M10	-	$\phi 8, \phi 10$	-	12	12	12	-	12	12
M12	M8	$\phi 10, \phi 12$	-	14	14	14	-	14	14
-	-	$\phi 12$	M12	16	16	16	-	16	16
M16	M10	$\phi 14$	-	18	18	18	18	18	18
-	-	$\phi 16$	M16	20	20	20	20	20	20
M20	M12	$\phi 18$	-	22	22	22	22	22	22
-	-	$\phi 20$	M20	25	25	25	25	25	25
M24	M16	-	-	28	28	28	28	28	28
M27	-	$\phi 24, \phi 25$	-	30	-	30	30	30	30
-	M20	$\phi 24, \phi 25$	M24	32	32	32	32	32	32
M30	-	$\phi 28$	M27	35	35	35	35	35	35
-	-	$\phi 30$	-	37	-	37	-	37	37
-	-	$\phi 32$	-	40	-	-	-	40	40
				-	-	42	-	42	42

¹⁾ With vacuum cleaner Hilti VC 10/20/40 (automatic filter cleaning activated, eco mode off) or a vacuum cleaner providing equivalent cleaning performance in combination with the specified Hilti hollow drill bit TE-CD or TE YD.







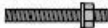

Injection system Hilti HIT-RE 500 V4

Intended use

Overview of installation options / Parameters of cleaning and setting tools

Annex B6

Table B9: Parameters of cleaning and setting tools

Steel elements		Drill and clean				Installation	
Fractional threaded rod (Annex A)	HIS-(R)N	Hammer drilling		Diamond coring		Brush	Piston plug
			Hollow drill bit TE-CD, TE-YD ¹⁾		Roughening tool TE-YRT		
							
Size [in]	Size [in]	d_0 [in.]	d_0 [in.]	d_0 [in.]	d_0 [in.]	HIT-RB	HIT-SZ
3/8	-	7/16	-	7/16	-	7/16	7/16
1/2	-	9/16	9/16	9/16	-	9/16	9/16
-	3/8	11/16	-	11/16	-	11/16	11/16
5/8	-	3/4	3/4	3/4	3/4	3/4	3/4
3/4	1/2	7/8	7/8	7/8	7/8	7/8	7/8
7/8	-	1	1	1	1	1	1
1	5/8	1 1/8	1 1/8	1 1/8	1 1/8	1 1/8	1 1/8
-	3/4	1 1/4	-	1 1/4	-	1 1/4	1 1/4
1 1/4	-	1 3/8	-	1 3/8	1 3/8	1 3/8	1 3/8

¹⁾ With vacuum cleaner Hilti VC 10/20/40 (automatic filter cleaning activated, eco mode off) or a vacuum cleaner providing equivalent cleaning performance in combination with the specified Hilti hollow drill bit TE-CD or TE YD.

Injection system Hilti HIT-RE 500 V4

Intended use

Overview of installation options / Parameters of cleaning and setting tools

Annex B7

Table B10: Cleaning alternatives



<p>Compressed Air Cleaning (CAC): air nozzle with an orifice opening of minimum 3,5 mm (1/7 in.) in diameter.</p>	
<p>Automatic Cleaning (AC): Cleaning is performed during drilling with Hilti TE-CD and TE-YD drilling system including vacuum cleaner.</p>	

Table B11: Parameters for use of the Hilti Roughening tool TE-YRT



Diamond coring			Roughening tool TE-YRT		Wear gauge RTG...	
						
d_0					size	
nominal [mm]	nominal [in.]	measured [mm]	d_0 [mm]	d_0 [in.]		
18	3/4	17,9 to 18,2	18	3/4	18	3/4
20	7/8	19,9 to 20,2	20	7/8	20	7/8
22	1	21,9 to 22,2	22	1	22	1
25	1 1/8	24,9 to 25,2	25	1 1/8	25	1 1/8
28	1 3/8	27,9 to 28,2	28	1 3/8	28	1 3/8
30	-	29,9 to 30,2	30	-	30	-
32	-	31,9 to 32,2	32	-	32	-
35	-	34,9 to 35,2	35	-	35	-

Table B12: Using parameters of the Hilti Roughening tool TE-YRT

h_{ef} [mm]	Roughening time $t_{roughen}$ ($t_{roughen}$ [sec] = h_{ef} [mm] / 10)
0 to 100	10
101 to 200	20
201 to 300	30
301 to 400	40
401 to 500	50
501 to 600	60

Table B13: Hilti Roughening tool TE-YRT and wear gauge RTG

TE-YRT	
RTG	

Injection system Hilti HIT-RE 500 V4

Intended use
 Cleaning alternatives / Parameters for use of roughening tool

Annex B8

Installation instructions

Hole drilling

a) Hammer drilling: For dry or wet concrete and installation in water-filled drill holes (no sea water).

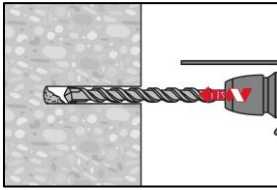

Drill hole to the required embedment depth with a hammer drill set in rotation-hammer mode using an appropriately sized carbide drill bit.

b) Hammer drilling with Hilti hollow drill bit TE-CD, TE-YD: For dry and wet concrete only.

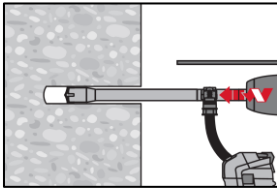

Drill hole to the required embedment depth with an appropriately sized Hilti hollow drill bit TE-CD or TE-YD attached to Hilti vacuum cleaner VC 10/20/40 (automatic filter cleaning activated, eco-mode off) or a vacuum cleaner providing equivalent performance in combination with the specified Hilti hollow drill bit TE-CD or TE-YD. This drilling system removes the dust and cleans the bore hole during drilling when used in accordance with the user's manual. After drilling is completed, proceed to the "injection preparation" step in the installation instruction.

c) Diamond coring: For dry and wet concrete only.

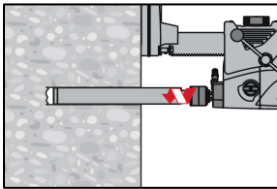

Diamond coring is permissible when suitable diamond core drilling machines and the corresponding core bits are used.

d) Diamond coring with roughening with Hilti Roughening tool TE-YRT: For dry and wet concrete only.

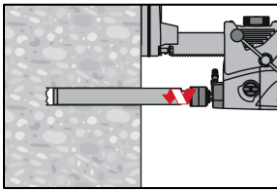

Diamond coring is permissible when suitable diamond core drilling machines and the corresponding core bits are used.

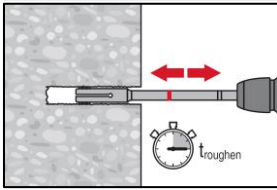

For the use in combination with Hilti Roughening tool TE-YRT see parameters in Table B8 and Table B9.

Before roughening free water needs to be removed from the borehole. Check usability of the roughening tool with the wear gauge RTG.

Roughen the borehole over the whole length to the required h_{ef} .

Injection system Hilti HIT-RE 500 V4

Intended use
 Installation instructions

Annex B9

Drill hole cleaning: Just before setting the steel element, the drill hole must be free of dust and debris.
Inadequate hole cleaning = poor load values.

Compressed Air Cleaning (CAC): For all drill hole diameters d_0 and all drill hole depths h_0 .

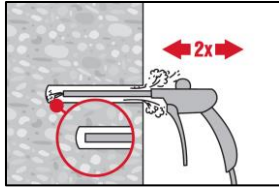

Blow 2 times from the back of the hole (if needed with nozzle extension) over the whole length with oil-free compressed air (min. 6 bar at 6 m³/h) until return air stream is free of noticeable dust.

For drill hole diameters ≥ 32 mm the compressor has to supply a minimum air flow of 140 m³/h.

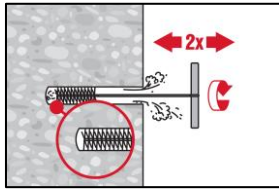

Brush 2 times with the specified brush (see Table B8 and Table B9) by inserting the steel brush Hilti HIT-RB to the back of the hole (if needed with extension) in a twisting motion and removing it.

The brush must produce natural resistance as it enters the drill hole (brush $\phi \geq$ drill hole ϕ) - if not the brush is too small and must be replaced with the proper brush diameter.

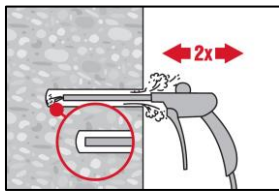

Blow again with compressed air 2 times until return air stream is free of noticeable dust.

Injection system Hilti HIT-RE 500 V4

Intended use
Installation instructions

Annex B10

Cleaning and water removal of water filled holes drilled with hammer drilling, hammer drilling with Hilti hollow drill bit and diamond coring

For all drill hole diameters d_0 and all drill hole depths h_0 .

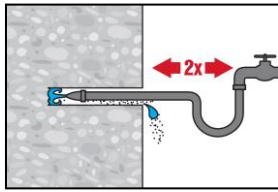

Flush 2 times by inserting a water hose (water-line pressure) to the back of the hole until water runs clear.

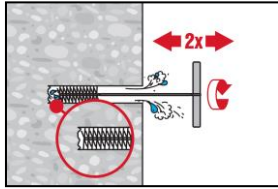

Brush 2 times with the specified brush (see Table B8 and Table B9) by inserting the steel brush Hilti HIT-RB to the back of the hole (if needed with extension) in a twisting motion and removing it.
 The brush must produce natural resistance as it enters the drill hole (brush $\phi \geq$ drill hole ϕ) - if not the brush is too small and must be replaced with the proper brush diameter.

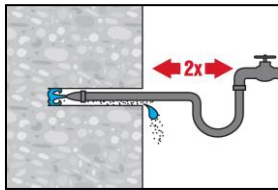

Flush 2 times by inserting a water hose (water-line pressure) to the back of the hole until water runs clear.

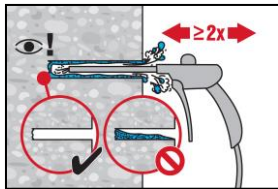

Blow 2 times from the back of the hole (if needed with nozzle extension) over the whole length with oil-free compressed air (min. 6 bar at 6 m³/h) until return air stream is free of noticeable dust and water.
 For drill hole diameters ≥ 32 mm the compressor has to supply a minimum air flow of 140 m³/h.

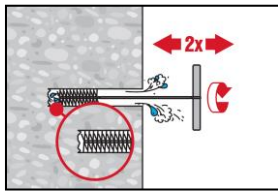

Brush 2 times with the specified brush size (see Table B8 and Table B9) by inserting the steel brush Hilti HIT-RB to the back of the hole (if needed with extension) in a twisting motion and removing it.
 The brush must produce natural resistance as it enters the drill hole – if not the brush is too small and must be replaced with the proper brush diameter.

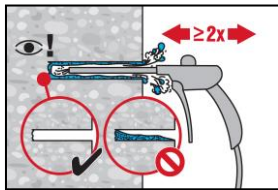

Blow again with compressed air 2 times until return air stream is free of noticeable dust and water.

Injection system Hilti HIT-RE 500 V4

Intended use
 Installation instructions

Annex B11

Cleaning of diamond cored holes with roughening with Hilti Roughening tool TE-YRT:

For all drill hole diameters d_0 and all drill hole depths h_0 .

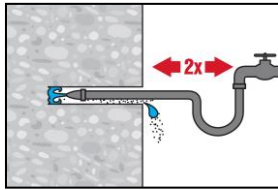

Flush 2 times by inserting a water hose (water-line pressure) to the back of the hole until water runs clear.

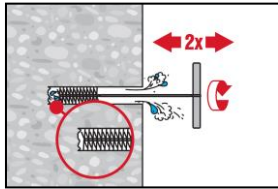

Brush 2 times with the specified brush (see Table B8 and Table B9) by inserting the steel brush Hilti HIT-RB to the back of the hole (if needed with extension) in a twisting motion and removing it.

The brush must produce natural resistance as it enters the drill hole (brush $\phi \geq$ drill hole ϕ) - if not the brush is too small and must be replaced with the proper brush diameter.

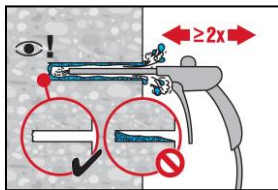

Blow 2 times from the back of the hole (if needed with nozzle extension) over the whole length with oil-free compressed air (min. 6 bar at 6 m³/h) until return air stream is free of noticeable dust and water.

For drill hole diameters ≥ 32 mm the compressor has to supply a minimum air flow of 140 m³/h.

Injection preparation

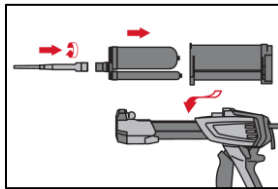

Tightly attach Hilti mixing nozzle HIT-RE-M to foil pack manifold. Do not modify the mixing nozzle.

Observe the instruction for use of the dispenser.

Check foil pack holder for proper function. Insert foil pack into foil pack holder and put holder into dispenser.

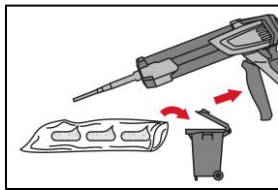

The foil pack opens automatically as dispensing is initiated. Depending on the size of the foil pack an initial amount of adhesive has to be discarded.

Discarded quantities are: 3 strokes for 330 ml foil pack,
 4 strokes for 500 ml foil pack,
 65 ml for 1400 ml foil pack.

The minimum foil pack temperature is +5°C.

Injection system Hilti HIT-RE 500 V4

Intended use
 Installation instructions

Annex B12

Inject adhesive from the back of the drill hole without forming air voids.

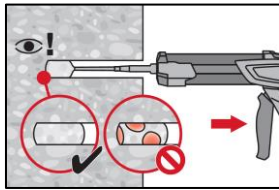

Inject the adhesive starting at the back of the hole, slowly withdrawing the mixer with each trigger pull.
 Fill approximately 2/3 of the drill hole to ensure that the annular gap between the steel element and the concrete is completely filled with adhesive along the embedment length.

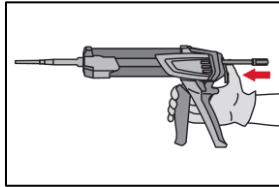

After injection is completed, depressurize the dispenser by pressing the release trigger. This will prevent further adhesive discharge from the mixer.

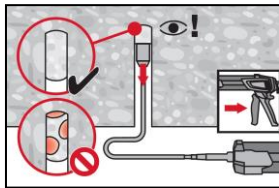

Overhead installation and/or installation with embedment depth $h_{ef} > 250$ mm.
 For overhead installation the injection is only possible with the aid of extensions and piston plugs. Assemble HIT-RE-M mixer, extension(s) and appropriately sized piston plug (see Table B8 and Table B9). Insert piston plug to back of the hole and inject adhesive. During injection the piston plug will be naturally extruded out of the drill hole by the adhesive pressure.

Setting the steel element

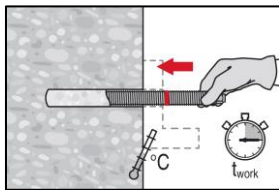

Before use, verify that the steel element is dry and free of oil and other contaminants. Mark and set steel element to the required embedment depth before working time t_{work} has elapsed. The working time t_{work} is given in Table B7.

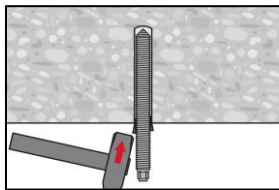

For overhead installation use piston plugs and fix embedded parts with e.g., wedges.

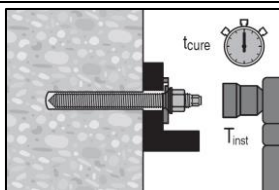

After required curing time t_{cure} (see Table B7) the fastening can be loaded.
 The applied installation torque shall not exceed the values max. T_{inst} given in Table B1 to Table B5.

Injection system Hilti HIT-RE 500 V4

Intended use
 Installation instructions

Annex B13

Installation of Hilti Filling Set

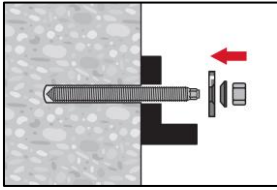

Use Hilti Filling Set with standard nut. Observe the correct orientation of filling washer and spherical washer.

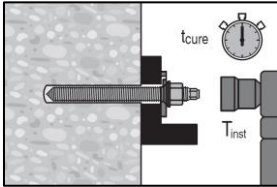

The applied installation torque shall not exceed the values max. T_{inst} given in in Table B1 to Table B5.

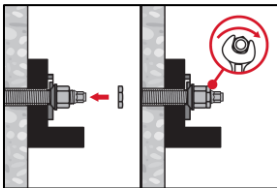

Optional:
Installation of lock nut. Tighten with a $\frac{1}{4}$ to $\frac{1}{2}$ turn. (Not for size M24.)

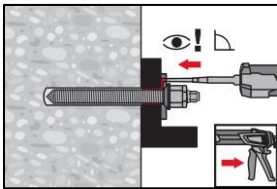

Fill the annular gap between the anchor rod and fixture with 1-3 strokes of a Hilti injection mortar HIT-HY ... or HIT-RE
Follow the installation instructions supplied with the Hilti injection mortar.
After required curing time t_{cure} , the fastening can be loaded.

Injection system Hilti HIT-RE 500 V4

Intended use
Installation instructions

Annex B14

Table C1: Essential characteristics for metric threaded rod according to Annex A under tension load in concrete

Metric threaded rod according to Annex A			M8	M10	M12	M16	M20	M24	M27	M30	
For a working life of 50 and 100 years											
Steel failure											
Characteristic resistance	$N_{Rk,s}$	[kN]	$A_s \cdot f_{uk}$								
Partial factor grade 5.8, 6.8, 8.8 (Table A2)	$\gamma_{Ms,N}^{1)}$	[-]	1,5								
Partial factor HAS A4, HAS-U A4, HIT-V-R, Threaded rod: CRC II and III (Table A2)	$\gamma_{Ms,N}^{1)}$	[-]	1,87						2,86		
Partial factor HAS-U HCR, HIT-V-HCR, Threaded rod: CRC V (Table A2)	$\gamma_{Ms,N}^{1)}$	[-]	1,5					2,1			
Installation factor											
Hammer drilling	γ_{inst}	[-]	1,0								
Hammer drilling with Hilti hollow drill bit TE-CD or TE-YD	γ_{inst}	[-]	1,0								
Diamond coring	γ_{inst}	[-]	1,2			1,4					
Diamond coring with roughening with Hilti Roughening tool TE-YRT	γ_{inst}	[-]	2)			1,0					
Hammer drilling in water-filled drill holes	γ_{inst}	[-]	1,4								
Concrete cone failure											
Factor for cracked concrete	$k_{cr,N}$	[-]	7,7								
Factor for uncracked concrete	$k_{ucr,N}$	[-]	11,0								
Edge distance	$c_{cr,N}$	[mm]	$1,5 \cdot h_{ef}$								
Spacing	$s_{cr,N}$	[mm]	$3,0 \cdot h_{ef}$								
Splitting failure											
Edge distance $c_{cr,sp}$ [mm] for	$h/h_{ef} \geq 2,0$		$1,0 \cdot h_{ef}$								
	$2,0 > h/h_{ef} > 1,3$		$4,6 \cdot h_{ef} - 1,8 \cdot h$								
	$h/h_{ef} \leq 1,3$		$2,26 \cdot h_{ef}$								
Spacing	$s_{cr,sp}$	[mm]	$2 \cdot c_{cr,sp}$								

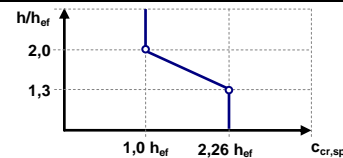

Injection system Hilti HIT-RE 500 V4

Performance
 Essential characteristics under tension load in concrete

Annex C1

Table C1: continued (1)

Metric threaded rod according to Annex A	M8	M10	M12	M16	M20	M24	M27	M30		
Combined pullout and concrete cone failure for a working life of 50 years										
Characteristic resistance in uncracked concrete C20/25 in hammer drilled holes and hammer drilled holes with Hilti hollow drill bit TE-CD or TE-YD and diamond cored holes with roughening with Hilti Roughening tool TE-YRT										
Temperature range I: 24°C / 40°C	$\tau_{Rk,ucr}$	[N/mm ²]	19	18	18	17	16	15	15	14
Temperature range II: 43°C / 55°C	$\tau_{Rk,ucr}$	[N/mm ²]	16	15	15	14	13	13	12	12
Temperature range III: 55°C / 75°C	$\tau_{Rk,ucr}$	[N/mm ²]	6,0	6,0	6,0	5,5	5,0	5,0	4,5	4,5
Characteristic resistance in uncracked concrete C20/25 in diamond cored holes										
Temperature range I: 24°C / 40°C	$\tau_{Rk,ucr}$	[N/mm ²]	13	13	13	13	12	12	12	12
Temperature range II: 43°C / 55°C	$\tau_{Rk,ucr}$	[N/mm ²]	12	12	11	11	11	11	11	10
Temperature range III: 55°C / 75°C	$\tau_{Rk,ucr}$	[N/mm ²]	6,0	5,5	5,5	5,5	5,5	5,5	5,5	5,0
Characteristic resistance in uncracked concrete C20/25 in hammer drilled holes and installation in water-filled drill holes										
Temperature range I: 24°C / 40°C	$\tau_{Rk,ucr}$	[N/mm ²]	16	16	15	15	14	13	12	12
Temperature range II: 43°C / 55°C	$\tau_{Rk,ucr}$	[N/mm ²]	13	13	13	12	11	11	10	10
Temperature range III: 55°C / 75°C	$\tau_{Rk,ucr}$	[N/mm ²]	5,0	5,0	5,0	4,5	4,5	4,0	4,0	4,0
Characteristic resistance in cracked concrete C20/25 in hammer drilled holes and hammer drilled holes with Hilti hollow drill bit TE-CD or TE-YD and diamond cored holes with roughening with Hilti Roughening tool TE-YRT										
Temperature range I: 24°C / 40°C	$\tau_{Rk,cr}$	[N/mm ²]	7,5	9,0	11	11	10	9,5	9,0	8,5
Temperature range II: 43°C / 55°C	$\tau_{Rk,cr}$	[N/mm ²]	7,0	8,0	9,0	8,5	8,0	8,0	7,5	7,0
Temperature range III: 55°C / 75°C	$\tau_{Rk,cr}$	[N/mm ²]	4,0	3,5	3,5	3,5	3,0	3,0	3,0	3,0
Influence factors ψ on bond resistance τ_{Rk} in cracked and uncracked concrete										
Influence of concrete strength										
in hammer drilled holes and hammer drilled holes with Hilti hollow drill bit TE-CD or TE-YD and diamond cored holes										
Temperature range I to III:	ψ_c	[-]	$(f_{ck}/20)^{0,1}$							
in diamond cored holes with roughening with Hilti Roughening tool TE-YRT										
Temperature range I to III:	ψ_c	[-]	2)			1,0				
Influence of sustained load										
in hammer drilled holes and hammer drilled holes with Hilti hollow drill bit TE-CD or TE-YD and diamond cored holes with roughening with Hilti Roughening tool TE-YRT										
Temperature range I: 24°C / 40°C	ψ_{sus}^0	[-]	0,88							
Temperature range II: 43°C / 55°C	ψ_{sus}^0	[-]	0,72							
Temperature range III: 55°C / 75°C	ψ_{sus}^0	[-]	0,69							
in diamond cored holes										
Temperature range I: 24°C / 40°C	ψ_{sus}^0	[-]	0,89							
Temperature range II: 43°C / 55°C	ψ_{sus}^0	[-]	0,70							
Temperature range III: 55°C / 75°C	ψ_{sus}^0	[-]	0,62							

Injection system Hilti HIT-RE 500 V4

Performance

Essential characteristics under tension load in concrete

Annex C2

Table C1: continued (2)

Metric threaded rod according to Annex A	M8	M10	M12	M16	M20	M24	M27	M30
Combined pullout and concrete cone failure for a working life of 100 years								
Characteristic resistance in uncracked concrete C20/25 in hammer drilled holes and hammer drilled holes with Hilti hollow drill bit TE-CD or TE-YD and diamond cored holes with roughening with Hilti Roughening tool TE-YRT								
Temperature range I: 24°C / 40°C $\tau_{Rk,100,ucr}$ [N/mm ²]	19	18	18	17	16	15	15	14
Temperature range II: 43°C / 55°C $\tau_{Rk,100,ucr}$ [N/mm ²]	15	15	15	14	13	13	12	11
Temperature range III: 55°C / 75°C $\tau_{Rk,100,ucr}$ [N/mm ²]	6,0	6,0	6,0	5,5	5,0	5,0	4,5	4,5
Characteristic resistance in uncracked concrete C20/25 in diamond cored holes								
Temperature range I: 24°C / 40°C $\tau_{Rk,100,ucr}$ [N/mm ²]	13	13	13	13	12	12	12	12
Temperature range II: 43°C / 55°C $\tau_{Rk,100,ucr}$ [N/mm ²]	12	12	11	11	11	11	11	10
Temperature range III: 55°C / 75°C $\tau_{Rk,100,ucr}$ [N/mm ²]	6,0	5,5	5,5	5,5	5,5	5,5	5,5	5,0
Characteristic resistance in uncracked concrete C20/25 in hammer drilled holes and installation in water-filled drill holes								
Temperature range I: 24°C / 40°C $\tau_{Rk,100,ucr}$ [N/mm ²]	16	16	15	15	14	13	12	12
Temperature range II: 43°C / 55°C $\tau_{Rk,100,ucr}$ [N/mm ²]	13	13	13	12	11	11	10	9,5
Temperature range III: 55°C / 75°C $\tau_{Rk,100,ucr}$ [N/mm ²]	5,0	5,0	5,0	4,5	4,5	4,0	4,0	4,0
Characteristic resistance in cracked concrete C20/25 in hammer drilled holes and hammer drilled holes with Hilti hollow drill bit TE-CD or TE-YD and diamond cored holes with roughening with Hilti Roughening tool TE-YRT								
Temperature range I: 24°C / 40°C $\tau_{Rk,100,cr}$ [N/mm ²]	7,0	8,0	9,0	8,5	8,0	7,5	7,0	6,5
Temperature range II: 43°C / 55°C $\tau_{Rk,100,cr}$ [N/mm ²]	6,0	7,0	8,0	7,5	7,0	6,5	6,5	6,0
Temperature range III: 55°C / 75°C $\tau_{Rk,100,cr}$ [N/mm ²]	4,0	3,5	3,5	3,5	3,0	3,0	3,0	3,0
Influence factors ψ on bond resistance $\tau_{Rk,100}$ in cracked and uncracked concrete								
Influence of concrete strength								
in hammer drilled holes and hammer drilled holes with Hilti hollow drill bit TE-CD or TE-YD and diamond cored holes								
Temperature range I to III:	ψ_c	[-]		$(f_{ck}/20)^{0,1}$				
in diamond cored holes with roughening with Hilti Roughening tool TE-YRT								
Temperature range I to III:	ψ_c	[-]		2)		1,0		
Influence of sustained load								
in hammer drilled holes and hammer drilled holes with Hilti hollow drill bit TE-CD or TE-YD and diamond cored holes with roughening with Hilti Roughening tool TE-YRT								
Temperature range I: 24°C / 40°C	$\psi_{sus,100}^0$	[-]		0,85				
Temperature range II: 43°C / 55°C	$\psi_{sus,100}^0$	[-]		0,72				
Temperature range III: 55°C / 75°C	$\psi_{sus,100}^0$	[-]		0,69				
in diamond cored holes								
Temperature range I: 24°C / 40°C	$\psi_{sus,100}^0$	[-]		0,70				
Temperature range II: 43°C / 55°C	$\psi_{sus,100}^0$	[-]		0,67				
Temperature range III: 55°C / 75°C	$\psi_{sus,100}^0$	[-]		0,62				

1) In absence of national regulations.

2) No performance assessed.

Injection system Hilti HIT-RE 500 V4

Performance

Essential characteristics under tension load in concrete

Annex C3

Table C2: Essential characteristics for fractional threaded rod according to Annex A under tension load in concrete

Fractional threaded rod according to Annex A		[in.]	3/8	1/2	5/8	3/4	7/8	1	1 1/4
For a working life of 50 and 100 years									
Steel failure									
Characteristic resistance	$N_{Rk,s}$	[kN]	$A_s \cdot f_{uk}$						
Partial factor HIT-V	$\gamma_{Ms,N}^{1)}$	[-]	1,92						
Partial factor HAS-V-36	$\gamma_{Ms,N}^{1)}$	[-]	1,94						
Partial factor HAS-E-55	$\gamma_{Ms,N}^{1)}$	[-]	1,64						
Partial factor HAS-B-105	$\gamma_{Ms,N}^{1)}$	[-]	1,43						
Partial factor HAS-R 304	$\gamma_{Ms,N}^{1)}$	[-]	1,85		2,27			3,01	
Partial factor HAS-R 316	$\gamma_{Ms,N}^{1)}$	[-]	1,85		2,27				
Installation factor									
Hammer drilling	γ_{inst}	[-]	1,0						
Hammer drilling with Hilti hollow drill bit TE-CD or TE-YD	γ_{inst}	[-]	2)	1,0					
Diamond coring	γ_{inst}	[-]	1,2		1,4				
Diamond coring with roughening with Hilti Roughening tool TE-YRT	γ_{inst}	[-]	2)	1,0					
Hammer drilling in water-filled drill holes	γ_{inst}	[-]	1,4						
Concrete cone failure									
Factor for cracked concrete	$k_{cr,N}$	[-]	7,7						
Factor for uncracked concrete	$k_{ucr,N}$	[-]	11,0						
Edge distance	$c_{cr,N}$	[mm]	$1,5 \cdot h_{ef}$						
Spacing	$s_{cr,N}$	[mm]	$3,0 \cdot h_{ef}$						
Splitting failure									
Edge distance $c_{cr,sp}$ [mm] for	$h/h_{ef} \geq 2,0$		$1,0 \cdot h_{ef}$						
	$2,0 > h/h_{ef} > 1,3$		$4,6 \cdot h_{ef} - 1,8 \cdot h$						
	$h/h_{ef} \leq 1,3$		$2,26 \cdot h_{ef}$						
Spacing	$s_{cr,sp}$	[mm]	$2 \cdot c_{cr,sp}$						

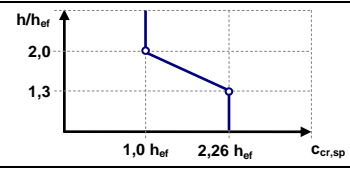

Injection system Hilti HIT-RE 500 V4

Performance
 Essential characteristics under tension load in concrete

Annex C4

Table C2: continued (1)

Fractional threaded rod according to Annex A	[in.]	3/8	1/2	5/8	3/4	7/8	1	1 1/4	
Combined pullout and concrete cone failure for a working life of 50 years									
Characteristic resistance in uncracked concrete C20/25 in hammer drilled holes and hammer drilled holes with Hilti hollow drill bit TE-CD or TE-YD and diamond cored holes with roughening with Hilti Roughening tool TE-YRT									
Temperature range I:	24°C / 40°C	$\tau_{Rk,ucr}$	[N/mm ²]	19	18	17	16	15	14
Temperature range II:	43°C / 55°C	$\tau_{Rk,ucr}$	[N/mm ²]	15	15	14	14	13	12
Temperature range III:	55°C / 75°C	$\tau_{Rk,ucr}$	[N/mm ²]	6,0	6,0	5,5	5,5	5,0	4,5
Characteristic resistance in uncracked concrete C20/25 in diamond cored holes									
Temperature range I:	24°C / 40°C	$\tau_{Rk,ucr}$	[N/mm ²]	13	13	13	12	12	12
Temperature range II:	43°C / 55°C	$\tau_{Rk,ucr}$	[N/mm ²]	12	11	11	11	11	10
Temperature range III:	55°C / 75°C	$\tau_{Rk,ucr}$	[N/mm ²]	5,5	5,5	5,5	5,5	5,5	5,0
Characteristic resistance in uncracked concrete C20/25 in hammer drilled holes and installation in water-filled drill holes									
Temperature range I:	24°C / 40°C	$\tau_{Rk,ucr}$	[N/mm ²]	16	15	15	14	13	13
Temperature range II:	43°C / 55°C	$\tau_{Rk,ucr}$	[N/mm ²]	13	13	12	12	11	11
Temperature range III:	55°C / 75°C	$\tau_{Rk,ucr}$	[N/mm ²]	5,0	5,0	4,5	4,5	4,5	4,0
Characteristic resistance in cracked concrete C20/25 in hammer drilled holes and hammer drilled holes with Hilti hollow drill bit TE-CD or TE-YD and diamond cored holes with roughening with Hilti Roughening tool TE-YRT									
Temperature range I:	24°C / 40°C	$\tau_{Rk,cr}$	[N/mm ²]	9,0	11	11	10	9,0	9,0
Temperature range II:	43°C / 55°C	$\tau_{Rk,cr}$	[N/mm ²]	8,0	9,0	8,5	8,5	8,0	7,5
Temperature range III:	55°C / 75°C	$\tau_{Rk,cr}$	[N/mm ²]	3,5	3,5	3,5	3,0	3,0	2,5
Influence factors ψ on bond resistance τ_{Rk} in cracked and uncracked concrete									
Influence of concrete strength									
in hammer drilled holes and hammer drilled holes with Hilti hollow drill bit TE-CD or TE-YD and diamond cored holes									
Temperature range I to III:	ψ_c	[-]							$(f_{ck}/20)^{0,1}$
in diamond cored holes with roughening with Hilti Roughening tool TE-YRT									
Temperature range I to III:	ψ_c	[-]							1,0
Influence of sustained load									
in hammer drilled holes and hammer drilled holes with Hilti hollow drill bit TE-CD or TE-YD and diamond cored holes with roughening with Hilti Roughening tool TE-YRT									
Temperature range I:	24°C / 40°C	ψ_{sus}^0	[-]						0,88
Temperature range II:	43°C / 55°C	ψ_{sus}^0	[-]						0,72
Temperature range III:	55°C / 75°C	ψ_{sus}^0	[-]						0,69
in diamond cored holes									
Temperature range I:	24°C / 40°C	ψ_{sus}^0	[-]						0,89
Temperature range II:	43°C / 55°C	ψ_{sus}^0	[-]						0,70
Temperature range III:	55°C / 75°C	ψ_{sus}^0	[-]						0,62

Injection system Hilti HIT-RE 500 V4

Performance

Essential characteristics under tension load in concrete

Annex C5

Table C2: continued (2)

Fractional threaded rod according to Annex A	[in.]	3/8	1/2	5/8	3/4	7/8	1	1 1/4	
Combined pullout and concrete cone failure for a working life of 100 years									
Characteristic resistance in uncracked concrete C20/25 in hammer drilled holes and hammer drilled holes with Hilti hollow drill bit TE-CD or TE-YD and diamond cored holes with roughening with Hilti Roughening tool TE-YRT									
Temperature range I:	24°C / 40°C	$\tau_{Rk,100,ucr}$ [N/mm ²]	19	18	17	16	16	15	14
Temperature range II:	43°C / 55°C	$\tau_{Rk,100,ucr}$ [N/mm ²]	15	15	14	13	13	12	11
Temperature range III:	55°C / 75°C	$\tau_{Rk,100,ucr}$ [N/mm ²]	6,0	6,0	5,5	5,5	5,0	5,0	4,5
Characteristic resistance in uncracked concrete C20/25 in diamond cored holes									
Temperature range I:	24°C / 40°C	$\tau_{Rk,100,ucr}$ [N/mm ²]	13	13	13	12	12	12	12
Temperature range II:	43°C / 55°C	$\tau_{Rk,100,ucr}$ [N/mm ²]	12	11	11	11	11	11	10
Temperature range III:	55°C / 75°C	$\tau_{Rk,100,ucr}$ [N/mm ²]	5,5	5,5	5,5	5,5	5,5	5,5	5,0
Characteristic resistance in uncracked concrete C20/25 in hammer drilled holes and installation in water-filled drill holes									
Temperature range I:	24°C / 40°C	$\tau_{Rk,100,ucr}$ [N/mm ²]	16	15	15	14	13	13	12
Temperature range II:	43°C / 55°C	$\tau_{Rk,100,ucr}$ [N/mm ²]	13	12	12	11	11	10	9,5
Temperature range III:	55°C / 75°C	$\tau_{Rk,100,ucr}$ [N/mm ²]	5,0	5,0	4,5	4,5	4,5	4,0	3,5
Characteristic resistance in cracked concrete C20/25 in hammer drilled holes and hammer drilled holes with Hilti hollow drill bit TE-CD or TE-YD and diamond cored holes with roughening with Hilti Roughening tool TE-YRT									
Temperature range I:	24°C / 40°C	$\tau_{Rk,100,cr}$ [N/mm ²]	8,0	8,5	8,5	8,0	7,5	7,5	6,5
Temperature range II:	43°C / 55°C	$\tau_{Rk,100,cr}$ [N/mm ²]	7,0	7,5	7,5	7,0	7,0	6,5	6,0
Temperature range III:	55°C / 75°C	$\tau_{Rk,100,cr}$ [N/mm ²]	3,5	3,5	3,5	3,0	3,0	3,0	2,5
Influence factors ψ on bond resistance $\tau_{Rk,100}$ in cracked and uncracked concrete									
Influence of concrete strength									
in hammer drilled holes and hammer drilled holes with Hilti hollow drill bit TE-CD or TE-YD and diamond cored holes									
Temperature range I to III:		ψ_c [-]	$(f_{ck}/20)^{0,1}$						
in diamond cored holes with roughening with Hilti Roughening tool TE-YRT									
Temperature range I to III:		ψ_c [-]	2)		1,0				
Influence of sustained load									
in hammer drilled holes and hammer drilled holes with Hilti hollow drill bit TE-CD or TE-YD and diamond cored holes with roughening with Hilti Roughening tool TE-YRT									
Temperature range I:	24°C / 40°C	$\psi_{sus,100}^0$ [-]	0,85						
Temperature range II:	43°C / 55°C	$\psi_{sus,100}^0$ [-]	0,72						
Temperature range III:	55°C / 75°C	$\psi_{sus,100}^0$ [-]	0,69						
in diamond cored holes									
Temperature range I:	24°C / 40°C	$\psi_{sus,100}^0$ [-]	0,70						
Temperature range II:	43°C / 55°C	$\psi_{sus,100}^0$ [-]	0,67						
Temperature range III:	55°C / 75°C	$\psi_{sus,100}^0$ [-]	0,62						

1) In absence of national regulations.

2) No performance assessed.

Injection system Hilti HIT-RE 500 V4

Performance

Essential characteristics under tension load in concrete

Annex C6

Table C3: Essential characteristics for internally threaded sleeve HIS-(R)N under tension load in concrete

HIS-(R)N		M8	M10	M12	M16	M20
Outer diameter of sleeve	d_{nom} [mm]	12,5	16,5	20,5	25,4	27,6
For a working life of 50 and 100 years						
Steel failure						
Characteristic resistance HIS-N with screw grade 8.8	$N_{Rk,s}$ [kN]	25	46	67	125	116
Partial factor	$\gamma_{Ms,N}^{1)}$ [-]	1,5				
Characteristic resistance HIS-RN with screw grade 70	$N_{Rk,s}$ [kN]	26	41	59	110	166
Partial factor	$\gamma_{Ms,N}^{1)}$ [-]	1,87				2,4
Installation factor						
Hammer drilling	γ_{inst} [-]	1,0				
Hammer drilling with Hilti hollow drill bit TE-CD or TE-YD	γ_{inst} [-]	1,0				
Diamond coring	γ_{inst} [-]	1,2	1,4			
Diamond coring with roughening with Hilti Roughening tool TE-YRT	γ_{inst} [-]	2)	1,0			
Hammer drilling in water-filled drill holes	γ_{inst} [-]	1,4				
Concrete cone failure						
Factor for cracked concrete	$k_{cr,N}$ [-]	7,7				
Factor for uncracked concrete	$k_{ucr,N}$ [-]	11,0				
Edge distance	$c_{cr,N}$ [mm]	$1,5 \cdot h_{ef}$				
Spacing	$s_{cr,N}$ [mm]	$3,0 \cdot h_{ef}$				
Splitting failure						
Edge distance $c_{cr,sp}$ [mm] for	$h/h_{ef} \geq 2,0$	$1,0 \cdot h_{ef}$				
	$2,0 > h/h_{ef} > 1,3$	$4,6 \cdot h_{ef} - 1,8 \cdot h$				
	$h/h_{ef} \leq 1,3$	$2,26 \cdot h_{ef}$				
Spacing	$s_{cr,sp}$ [mm]	$2 \cdot c_{cr,sp}$				

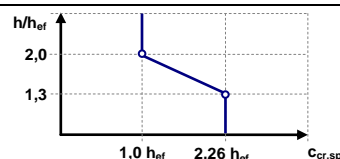

Injection system Hilti HIT-RE 500 V4

Performance
 Essential characteristics under tension load in concrete

Annex C7

Table C3: continued (1)

HIS-(R)N		M8	M10	M12	M16	M20
Outer diameter of sleeve	d_{nom} [mm]	12,5	16,5	20,5	25,4	27,6
Combined pullout and concrete cone failure for a working life of 50 years						
Characteristic resistance in uncracked concrete C20/25 in hammer drilled holes and hammer drilled holes with Hilti hollow drill bit TE-CD or TE-YD and diamond cored holes with roughening with Hilti Roughening tool TE-YRT						
Temperature range I:	24°C / 40°C $\tau_{Rk,ucr}$ [N/mm ²]	14	14	14	14	14
Temperature range II:	43°C / 55°C $\tau_{Rk,ucr}$ [N/mm ²]	12	12	12	12	12
Temperature range III:	55°C / 75°C $\tau_{Rk,ucr}$ [N/mm ²]	4,5	4,5	4,5	4,5	4,5
Characteristic resistance in uncracked concrete C20/25 in diamond cored holes						
Temperature range I:	24°C / 40°C $\tau_{Rk,ucr}$ [N/mm ²]	8,5	9,0	9,5	10	10
Temperature range II:	43°C / 55°C $\tau_{Rk,ucr}$ [N/mm ²]	8,0	8,0	8,5	9,0	9,0
Temperature range III:	55°C / 75°C $\tau_{Rk,ucr}$ [N/mm ²]	4,0	4,0	4,0	4,5	4,5
Characteristic resistance in uncracked concrete C20/25 in hammer drilled holes and installation in water-filled drill holes						
Temperature range I:	24°C / 40°C $\tau_{Rk,ucr}$ [N/mm ²]	12	12	12	12	12
Temperature range II:	43°C / 55°C $\tau_{Rk,ucr}$ [N/mm ²]	10	10	10	10	10
Temperature range III:	55°C / 75°C $\tau_{Rk,ucr}$ [N/mm ²]	4,0	4,0	4,0	4,0	4,0
Characteristic resistance in cracked concrete C20/25 in hammer drilled holes and hammer drilled holes with Hilti hollow drill bit TE-CD or TE-YD and diamond cored holes with roughening with Hilti Roughening tool TE-YRT						
Temperature range I:	24°C / 40°C $\tau_{Rk,cr}$ [N/mm ²]	9,0	9,0	9,0	9,0	9,0
Temperature range II:	43°C / 55°C $\tau_{Rk,cr}$ [N/mm ²]	8,0	8,0	8,0	8,0	8,0
Temperature range III:	55°C / 75°C $\tau_{Rk,cr}$ [N/mm ²]	3,0	3,0	3,0	3,0	3,0
Influence factors ψ on bond resistance τ_{Rk} in cracked and uncracked concrete						
Influence of concrete strength						
in hammer drilled holes and hammer drilled holes with Hilti hollow drill bit TE-CD or TE-YD and diamond cored holes						
Temperature range I to III:	ψ_c [-]	$(f_{ck}/20)^{0,1}$				
in diamond cored holes with roughening with Hilti Roughening tool TE-YRT						
Temperature range I to III:	ψ_c [-]	2)		1,0		
Influence of sustained load						
in hammer drilled holes and hammer drilled holes with Hilti hollow drill bit TE-CD or TE-YD and diamond cored holes with roughening with Hilti Roughening tool TE-YRT						
Temperature range I:	24°C / 40°C ψ_{SUS}^0 [-]				0,88	
Temperature range II:	43°C / 55°C ψ_{SUS}^0 [-]				0,72	
Temperature range III:	55°C / 75°C ψ_{SUS}^0 [-]				0,69	
in diamond cored holes						
Temperature range I:	24°C / 40°C ψ_{SUS}^0 [-]				0,89	
Temperature range II:	43°C / 55°C ψ_{SUS}^0 [-]				0,70	
Temperature range III:	55°C / 75°C ψ_{SUS}^0 [-]				0,62	

Injection system Hilti HIT-RE 500 V4

Performance

Essential characteristics under tension load in concrete

Annex C8

Table C3: continued (2)

HIS-(R)N	M8	M10	M12	M16	M20
Outer diameter of sleeve d_{nom} [mm]	12,5	16,5	20,5	25,4	27,6
Combined pullout and concrete cone failure for a working life of 100 years					
Characteristic resistance in uncracked concrete C20/25 in hammer drilled holes and hammer drilled holes with Hilti hollow drill bit TE-CD or TE-YD and diamond cored holes with roughening with Hilti Roughening tool TE-YRT					
Temperature range I: 24°C / 40°C $\tau_{Rk,100,ucr}$ [N/mm ²]	14	14	14	14	14
Temperature range II: 43°C / 55°C $\tau_{Rk,100,ucr}$ [N/mm ²]	11	11	11	11	11
Temperature range III: 55°C / 75°C $\tau_{Rk,100,ucr}$ [N/mm ²]	4,5	4,5	4,5	4,5	4,5
Characteristic resistance in uncracked concrete C20/25 in diamond cored holes					
Temperature range I: 24°C / 40°C $\tau_{Rk,100,ucr}$ [N/mm ²]	8,5	9,0	9,5	10	10
Temperature range II: 43°C / 55°C $\tau_{Rk,100,ucr}$ [N/mm ²]	8,0	8,0	8,5	9,0	9,0
Temperature range III: 55°C / 75°C $\tau_{Rk,100,ucr}$ [N/mm ²]	4,0	4,0	4,0	4,5	4,5
Characteristic resistance in uncracked concrete C20/25 in hammer drilled holes and installation in water-filled drill holes					
Temperature range I: 24°C / 40°C $\tau_{Rk,100,ucr}$ [N/mm ²]	12	12	12	12	12
Temperature range II: 43°C / 55°C $\tau_{Rk,100,ucr}$ [N/mm ²]	9,5	9,5	9,5	9,5	9,5
Temperature range III: 55°C / 75°C $\tau_{Rk,100,ucr}$ [N/mm ²]	4,0	4,0	4,0	4,0	4,0
Characteristic resistance in cracked concrete C20/25 in hammer drilled holes and hammer drilled holes with Hilti hollow drill bit TE-CD or TE-YD and diamond cored holes with roughening with Hilti Roughening tool TE-YRT					
Temperature range I: 24°C / 40°C $\tau_{Rk,100,cr}$ [N/mm ²]	7,0	7,0	7,0	7,0	7,0
Temperature range II: 43°C / 55°C $\tau_{Rk,100,cr}$ [N/mm ²]	6,0	6,5	6,5	6,5	6,5
Temperature range III: 55°C / 75°C $\tau_{Rk,100,cr}$ [N/mm ²]	3,0	3,0	3,0	3,0	3,0
Influence factors ψ on bond resistance $\tau_{Rk,100}$ in cracked and uncracked concrete					
Influence of concrete strength					
in hammer drilled holes and hammer drilled holes with Hilti hollow drill bit TE-CD or TE-YD and diamond cored holes					
Temperature range I to III: ψ_c [-]	$(f_{ck}/20)^{0,1}$				
in diamond cored holes with roughening with Hilti Roughening tool TE-YRT					
Temperature range I to III: ψ_c [-]	2)		1,0		
Influence of sustained load					
in hammer drilled holes and hammer drilled holes with Hilti hollow drill bit TE-CD or TE-YD and diamond cored holes with roughening with Hilti Roughening tool TE-YRT					
Temperature range I: 24°C / 40°C $\psi_{sus,100}^0$ [-]	0,85				
Temperature range II: 43°C / 55°C $\psi_{sus,100}^0$ [-]	0,72				
Temperature range III: 55°C / 75°C $\psi_{sus,100}^0$ [-]	0,69				
in diamond cored holes					
Temperature range I: 24°C / 40°C $\psi_{sus,100}^0$ [-]	0,70				
Temperature range II: 43°C / 55°C $\psi_{sus,100}^0$ [-]	0,67				
Temperature range III: 55°C / 75°C $\psi_{sus,100}^0$ [-]	0,62				

1) In absence of national regulations.

2) No performance assessed.

Injection system Hilti HIT-RE 500 V4

Performance

Essential characteristics under tension load in concrete

Annex C9

Table C4: Essential characteristics for internally threaded sleeve HIS-(R)N under tension load in concrete

HIS-(R)N, size		[in.]	3/8	1/2	5/8	3/4
Outer diameter of sleeve	d_{nom}	[mm]	16,5	20,5	25,4	27,6
For a working life of 50 and 100 years						
Steel failure						
Characteristic resistance HIS-N Screw acc. to SAE J429 Grade 5 or ASTM A325 (1/2 in. to 3/4 in.)	$N_{Rk,s}$	[kN]	41	76	121	130
Partial factor	$\gamma_{Ms,N}^{1)}$	[-]	1,57			1,50
Characteristic resistance HIS-N Screw acc. to ASTM A193 Grade B7	$N_{Rk,s}$	[kN]	43	77	128	130
Partial factor	$\gamma_{Ms,N}^{1)}$	[-]	1,43	1,50		
Characteristic resistance HIS-RN Screw acc. to ASTM A193 Grade B8M	$N_{Rk,s}$	[kN]	38	110	182	185
Partial factor	$\gamma_{Ms,N}^{1)}$	[-]	1,40	2,40		
Characteristic resistance HIS-RN Screw acc. to ASTM A193 Grade B8T	$N_{Rk,s}$	[kN]	43	110	182	185
Partial factor	$\gamma_{Ms,N}^{1)}$	[-]	1,50	2,40		
Installation factor						
Hammer drilling	γ_{inst}	[-]	1,0			
Hammer drilling with Hilti hollow drill bit TE-CD or TE-YD	γ_{inst}	[-]	2)	1,0		2)
Diamond coring	γ_{inst}	[-]	1,4			
Diamond coring with roughening with Hilti Roughening tool TE-YRT	γ_{inst}	[-]	2)	1,0		2)
Hammer drilling in water-filled drill holes	γ_{inst}	[-]	1,4			
Concrete cone failure						
Factor for cracked concrete	$k_{cr,N}$	[-]	7,7			
Factor for uncracked concrete	$k_{ucr,N}$	[-]	11,0			
Edge distance	$c_{cr,N}$	[mm]	1,5 · h_{ef}			
Spacing	$s_{cr,N}$	[mm]	3,0 · h_{ef}			
Splitting failure						
Edge distance $c_{cr,sp}$ [mm] for	$h/h_{ef} \geq 2,0$		$1,0 \cdot h_{ef}$			
	$2,0 > h/h_{ef} > 1,3$		$4,6 \cdot h_{ef} - 1,8 \cdot h$			
	$h/h_{ef} \leq 1,3$		$2,26 \cdot h_{ef}$			
Spacing	$s_{cr,sp}$	[mm]	$2 \cdot c_{cr,sp}$			

Injection system Hilti HIT-RE 500 V4

Performance
Essential characteristics under tension load in concrete

Annex C10

Table C4: continued (1)

HIS-(R)N, size	[in.]	3/8	1/2	5/8	3/4
Outer diameter of sleeve	d_{nom} [mm]	16,5	20,5	25,4	27,6
Combined pullout and concrete cone failure for a working life of 50 years					
Characteristic resistance in uncracked concrete C20/25 in hammer drilled holes and hammer drilled holes with Hilti hollow drill bit TE-CD or TE-YD and diamond cored holes with roughening with Hilti Roughening tool TE-YRT					
Temperature range I: 24°C / 40°C	$\tau_{RK,ucr}$ [N/mm ²]	14	14	14	14
Temperature range II: 43°C / 55°C	$\tau_{RK,ucr}$ [N/mm ²]	12	12	12	12
Temperature range III: 55°C / 75°C	$\tau_{RK,ucr}$ [N/mm ²]	4,5	4,5	4,5	4,5
Characteristic resistance in uncracked concrete C20/25 in diamond cored holes					
Temperature range I: 24°C / 40°C	$\tau_{RK,ucr}$ [N/mm ²]	9,0	9,5	10	10
Temperature range II: 43°C / 55°C	$\tau_{RK,ucr}$ [N/mm ²]	8,0	8,5	9,0	9,0
Temperature range III: 55°C / 75°C	$\tau_{RK,ucr}$ [N/mm ²]	4,0	4,0	4,5	4,5
Characteristic resistance in uncracked concrete C20/25 in hammer drilled holes and installation in water-filled drill holes					
Temperature range I: 24°C / 40°C	$\tau_{RK,ucr}$ [N/mm ²]	12	12	12	12
Temperature range II: 43°C / 55°C	$\tau_{RK,ucr}$ [N/mm ²]	10	10	10	10
Temperature range III: 55°C / 75°C	$\tau_{RK,ucr}$ [N/mm ²]	4,0	4,0	4,0	4,0
Characteristic resistance in cracked concrete C20/25 in hammer drilled holes and hammer drilled holes with Hilti hollow drill bit TE-CD or TE-YD and diamond cored holes with roughening with Hilti Roughening tool TE-YRT					
Temperature range I: 24°C / 40°C	$\tau_{RK,cr}$ [N/mm ²]	9,0	9,0	9,0	9,0
Temperature range II: 43°C / 55°C	$\tau_{RK,cr}$ [N/mm ²]	8,0	8,0	8,0	8,0
Temperature range III: 55°C / 75°C	$\tau_{RK,cr}$ [N/mm ²]	3,0	3,0	3,0	3,0
Influence factors ψ on bond resistance τ_{rk} in cracked and uncracked concrete					
Influence of concrete strength					
in hammer drilled holes and hammer drilled holes with Hilti hollow drill bit TE-CD or TE-YD and diamond cored holes					
Temperature range I to III:	ψ_c [-]	$(f_{ck}/20)^{0,1}$			
in diamond cored holes with roughening with Hilti Roughening tool TE-YRT					
Temperature range I to III:	ψ_c [-]	2)	1,0		2)
Influence of sustained load					
in hammer drilled holes and hammer drilled holes with Hilti hollow drill bit TE-CD or TE-YD and diamond cored holes with roughening with Hilti Roughening tool TE-YRT					
Temperature range I: 24°C / 40°C	ψ_{sus}^0 [-]	0,88			
Temperature range II: 43°C / 55°C	ψ_{sus}^0 [-]	0,72			
Temperature range III: 55°C / 75°C	ψ_{sus}^0 [-]	0,69			
in diamond cored holes					
Temperature range I: 24°C / 40°C	ψ_{sus}^0 [-]	0,89			
Temperature range II: 43°C / 55°C	ψ_{sus}^0 [-]	0,70			
Temperature range III: 55°C / 75°C	ψ_{sus}^0 [-]	0,62			

Injection system Hilti HIT-RE 500 V4

Performance

Essential characteristics under tension load in concrete

Annex C11

Table C4: continued (2)

HIS-(R)N, size	[in.]	3/8	1/2	5/8	3/4
Outer diameter of sleeve	d_{nom} [mm]	16,5	20,5	25,4	27,6
Combined pullout and concrete cone failure for a working life of 100 years					
Characteristic resistance in uncracked concrete C20/25 in hammer drilled holes and hammer drilled holes with Hilti hollow drill bit TE-CD or TE-YD and diamond cored holes with roughening with Hilti Roughening tool TE-YRT					
Temperature range I:	24°C / 40°C	$\tau_{Rk,100,ucr}$ [N/mm ²]	14	14	14
Temperature range II:	43°C / 55°C	$\tau_{Rk,100,ucr}$ [N/mm ²]	11	11	11
Temperature range III:	55°C / 75°C	$\tau_{Rk,100,ucr}$ [N/mm ²]	4,5	4,5	4,5
Characteristic resistance in uncracked concrete C20/25 in diamond cored holes					
Temperature range I:	24°C / 40°C	$\tau_{Rk,100,ucr}$ [N/mm ²]	9,0	9,5	10
Temperature range II:	43°C / 55°C	$\tau_{Rk,100,ucr}$ [N/mm ²]	8,0	8,5	9,0
Temperature range III:	55°C / 75°C	$\tau_{Rk,100,ucr}$ [N/mm ²]	4,0	4,0	4,5
Characteristic resistance in uncracked concrete C20/25 in hammer drilled holes and installation in water-filled drill holes					
Temperature range I:	24°C / 40°C	$\tau_{Rk,100,ucr}$ [N/mm ²]	12	12	12
Temperature range II:	43°C / 55°C	$\tau_{Rk,100,ucr}$ [N/mm ²]	9,5	9,5	9,5
Temperature range III:	55°C / 75°C	$\tau_{Rk,100,ucr}$ [N/mm ²]	4,0	4,0	4,0
Characteristic resistance in cracked concrete C20/25 in hammer drilled holes and hammer drilled holes with Hilti hollow drill bit TE-CD or TE-YD and diamond cored holes with roughening with Hilti Roughening tool TE-YRT					
Temperature range I:	24°C / 40°C	$\tau_{Rk,100,cr}$ [N/mm ²]	7,0	7,0	7,0
Temperature range II:	43°C / 55°C	$\tau_{Rk,100,cr}$ [N/mm ²]	6,5	6,5	6,5
Temperature range III:	55°C / 75°C	$\tau_{Rk,100,cr}$ [N/mm ²]	3,0	3,0	3,0
Influence factors ψ on bond resistance $\tau_{Rk,100}$ in cracked and uncracked concrete					
Influence of concrete strength					
in hammer drilled holes and hammer drilled holes with Hilti hollow drill bit TE-CD or TE-YD and diamond cored holes					
Temperature range I to III:	ψ_c	[-]	$(f_{ck}/20)^{0,1}$		
in diamond cored holes with roughening with Hilti Roughening tool TE-YRT					
Temperature range I to III:	ψ_c	[-]	2)	1,0	2)
Influence of sustained load					
in hammer drilled holes and hammer drilled holes with Hilti hollow drill bit TE-CD or TE-YD and diamond cored holes with roughening with Hilti Roughening tool TE-YRT					
Temperature range I:	24°C / 40°C	$\psi_{sus,100}^0$	[-]	0,85	
Temperature range II:	43°C / 55°C	$\psi_{sus,100}^0$	[-]	0,72	
Temperature range III:	55°C / 75°C	$\psi_{sus,100}^0$	[-]	0,69	
in diamond cored holes					
Temperature range I:	24°C / 40°C	$\psi_{sus,100}^0$	[-]	0,70	
Temperature range II:	43°C / 55°C	$\psi_{sus,100}^0$	[-]	0,67	
Temperature range III:	55°C / 75°C	$\psi_{sus,100}^0$	[-]	0,62	

1) In absence of national regulations.

2) No performance assessed.

Injection system Hilti HIT-RE 500 V4

Performance

Essential characteristics under tension load in concrete

Annex C12

Table C5: Essential characteristics for Hilti Tension anchor HZA / HZA-R under tension load in concrete

HZA / HZA-R		M12	M16	M20	M24	M27
Rebar diameter	ϕ [mm]	12	16	20	25	28
For a working life of 50 and 100 years						
Steel failure						
Characteristic resistance HZA	$N_{Rk,s}$ [kN]	46	86	135	194	253
Characteristic resistance HZA-R	$N_{Rk,s}$ [kN]	62	111	173	248	1)
Partial factor	$\gamma_{Ms,N}$ 1)	1,4				
Installation factor						
Hammer drilling	γ_{inst} [-]	1,0				
Hammer drilling with Hilti hollow drill bit TE-CD or TE-YD	γ_{inst} [-]	1,0				
Diamond coring	γ_{inst} [-]	1,2	1,4			
Diamond coring with roughening with Hilti Roughening tool TE-YRT	γ_{inst} [-]	2)	1,0			
Hammer drilling in water-filled drill holes	γ_{inst} [-]	1,4				
Concrete cone failure						
Factor for cracked concrete	$k_{cr,N}$ [-]	7,7				
Factor for uncracked concrete	$k_{ucr,N}$ [-]	11,0				
Edge distance	$c_{cr,N}$ [mm]	$1,5 \cdot h_{ef}$				
Spacing	$s_{cr,N}$ [mm]	$3,0 \cdot h_{ef}$				
Splitting failure						
Edge distance $c_{cr,sp}$ [mm] for	$h/h_{ef} \geq 2,0$	$1,0 \cdot h_{ef}$				
	$2,0 > h/h_{ef} > 1,3$	$4,6 \cdot h_{ef} - 1,8 \cdot h$				
	$h/h_{ef} \leq 1,3$	$2,26 \cdot h_{ef}$				
Spacing	$s_{cr,sp}$ [mm]	$2 \cdot c_{cr,sp}$				

1) In absence of national regulations.
 2) No performance assessed.

Injection system Hilti HIT-RE 500 V4

Performance
 Essential characteristics under tension load in concrete

Annex C13

Table C5: continued (1)

HZA / HZA-R	M12	M16	M20	M24	M27
Rebar diameter ϕ [mm]	12	16	20	25	28
Combined pullout and concrete cone failure for a working life of 50 years					
Characteristic resistance in uncracked concrete C20/25 in hammer drilled holes and hammer drilled holes with Hilti hollow drill bit TE-CD or TE-YD and diamond cored holes with roughening with Hilti Roughening tool TE-YRT					
Temperature range I: 24°C / 40°C $\tau_{RK,ucr}$ [N/mm ²]	15	15	14	14	14
Temperature range II: 43°C / 55°C $\tau_{RK,ucr}$ [N/mm ²]	12	12	12	11	11
Temperature range III: 55°C / 75°C $\tau_{RK,ucr}$ [N/mm ²]	5,0	4,5	4,5	4,5	4,5
Characteristic resistance in uncracked concrete C20/25 in diamond cored holes					
Temperature range I: 24°C / 40°C $\tau_{RK,ucr}$ [N/mm ²]	9,5	9,5	9,5	9,5	10
Temperature range II: 43°C / 55°C $\tau_{RK,ucr}$ [N/mm ²]	8,5	8,5	8,5	8,5	8,5
Temperature range III: 55°C / 75°C $\tau_{RK,ucr}$ [N/mm ²]	4,0	4,0	4,0	4,5	4,5
Characteristic resistance in uncracked concrete C20/25 in hammer drilled holes and installation in water-filled drill holes					
Temperature range I: 24°C / 40°C $\tau_{RK,ucr}$ [N/mm ²]	13	12	12	12	12
Temperature range II: 43°C / 55°C $\tau_{RK,ucr}$ [N/mm ²]	11	10	10	10	9,5
Temperature range III: 55°C / 75°C $\tau_{RK,ucr}$ [N/mm ²]	4,0	4,0	4,0	4,0	3,5
Characteristic resistance in cracked concrete C20/25 in hammer drilled holes and hammer drilled holes with Hilti hollow drill bit TE-CD or TE-YD and diamond cored holes with roughening with Hilti Roughening tool TE-YRT					
Temperature range I: 24°C / 40°C $\tau_{RK,cr}$ [N/mm ²]	12	12	12	11	11
Temperature range II: 43°C / 55°C $\tau_{RK,cr}$ [N/mm ²]	10	10	10	9,5	9,5
Temperature range III: 55°C / 75°C $\tau_{RK,cr}$ [N/mm ²]	4,0	4,0	3,5	3,5	3,5
Influence factors ψ on bond resistance τ_{rk} in cracked and uncracked concrete					
Influence of concrete strength					
in hammer drilled holes and hammer drilled holes with Hilti hollow drill bit TE-CD or TE-YD and diamond cored holes					
Temperature range I to III: ψ_c [-]	$(f_{ck}/20)^{0,1}$				
in diamond cored holes with roughening with Hilti Roughening tool TE-YRT					
Temperature range I to III: ψ_c [-]	1,0				
Influence of sustained load					
in hammer drilled holes and hammer drilled holes with Hilti hollow drill bit TE-CD or TE-YD and diamond cored holes with roughening with Hilti Roughening tool TE-YRT					
Temperature range I: 24°C / 40°C ψ_{SUS}^0 [-]	0,88				
Temperature range II: 43°C / 55°C ψ_{SUS}^0 [-]	0,72				
Temperature range III: 55°C / 75°C ψ_{SUS}^0 [-]	0,69				
in diamond cored holes					
Temperature range I: 24°C / 40°C ψ_{SUS}^0 [-]	0,89				
Temperature range II: 43°C / 55°C ψ_{SUS}^0 [-]	0,70				
Temperature range III: 55°C / 75°C ψ_{SUS}^0 [-]	0,62				

Injection system Hilti HIT-RE 500 V4

Performance

Essential characteristics under tension load in concrete

Annex C14

Table C5: continued (2)

HZA / HZA-R	M12	M16	M20	M24	M27
Rebar diameter ϕ [mm]	12	16	20	25	28
Combined pullout and concrete cone failure for a working life of 100 years					
Characteristic resistance in uncracked concrete C20/25 in hammer drilled holes and hammer drilled holes with Hilti hollow drill bit TE-CD or TE-YD and diamond cored holes with roughening with Hilti Roughening tool TE-YRT					
Temperature range I: 24°C / 40°C $\tau_{Rk,100,ucr}$ [N/mm ²]	15	15	14	14	14
Temperature range II: 43°C / 55°C $\tau_{Rk,100,ucr}$ [N/mm ²]	12	12	12	11	11
Temperature range III: 55°C / 75°C $\tau_{Rk,100,ucr}$ [N/mm ²]	5,0	4,5	4,5	4,5	4,5
Characteristic resistance in uncracked concrete C20/25 in diamond cored holes					
Temperature range I: 24°C / 40°C $\tau_{Rk,100,ucr}$ [N/mm ²]	9,5	9,5	9,5	9,5	10
Temperature range II: 43°C / 55°C $\tau_{Rk,100,ucr}$ [N/mm ²]	8,5	8,5	8,5	8,5	8,5
Temperature range III: 55°C / 75°C $\tau_{Rk,100,ucr}$ [N/mm ²]	4,0	4,0	4,0	4,5	4,5
Characteristic resistance in uncracked concrete C20/25 in hammer drilled holes and installation in water-filled drill holes					
Temperature range I: 24°C / 40°C $\tau_{Rk,100,ucr}$ [N/mm ²]	13	12	12	12	12
Temperature range II: 43°C / 55°C $\tau_{Rk,100,ucr}$ [N/mm ²]	10	10	10	9,5	9,5
Temperature range III: 55°C / 75°C $\tau_{Rk,100,ucr}$ [N/mm ²]	4,0	4,0	4,0	4,0	3,5
Characteristic resistance in cracked concrete C20/25 in hammer drilled holes and hammer drilled holes with Hilti hollow drill bit TE-CD or TE-YD and diamond cored holes with roughening with Hilti Roughening tool TE-YRT					
Temperature range I: 24°C / 40°C $\tau_{Rk,100,cr}$ [N/mm ²]	10	9,5	9,5	9,0	9,0
Temperature range II: 43°C / 55°C $\tau_{Rk,100,cr}$ [N/mm ²]	9,0	8,5	8,5	8,0	8,0
Temperature range III: 55°C / 75°C $\tau_{Rk,100,cr}$ [N/mm ²]	4,0	4,0	3,5	3,5	3,5
Influence factors ψ on bond resistance $\tau_{Rk,100}$ in cracked and uncracked concrete					
Influence of concrete strength					
in hammer drilled holes and hammer drilled holes with Hilti hollow drill bit TE-CD or TE-YD and diamond cored holes					
Temperature range I to III: ψ_c [-]					$(f_{ck}/20)^{0,1}$
in diamond cored holes with roughening with Hilti Roughening tool TE-YRT					
Temperature range I to III: ψ_c [-]		¹⁾			1,0
Influence of sustained load					
in hammer drilled holes and hammer drilled holes with Hilti hollow drill bit TE-CD or TE-YD and diamond cored holes with roughening with Hilti Roughening tool TE-YRT					
Temperature range I: 24°C / 40°C $\psi_{sus,100}^0$ [-]					0,85
Temperature range II: 43°C / 55°C $\psi_{sus,100}^0$ [-]					0,72
Temperature range III: 55°C / 75°C $\psi_{sus,100}^0$ [-]					0,69
in diamond cored holes					
Temperature range I: 24°C / 40°C $\psi_{sus,100}^0$ [-]					0,70
Temperature range II: 43°C / 55°C $\psi_{sus,100}^0$ [-]					0,67
Temperature range III: 55°C / 75°C $\psi_{sus,100}^0$ [-]					0,62

¹⁾ No performance assessed.

Injection system Hilti HIT-RE 500 V4

Performance

Essential characteristics under tension load in concrete

Annex C15

Table C6: Essential characteristics for reinforcing bars (rebars) under tension load in concrete

Reinforcing bar (rebar)	$\phi 8$	$\phi 10$	$\phi 12$	$\phi 14$	$\phi 16$	$\phi 18$	$\phi 20$	$\phi 24$	$\phi 25$	$\phi 28$	$\phi 30$	$\phi 32$	
For a working life of 50 and 100 years													
Steel failure													
Characteristic resistance $N_{Rk,s}$ [kN]	$A_s \cdot f_{uk}^{1)}$												
Characteristic resistance Rebar B500B acc. to DIN 488 ²⁾ $N_{Rk,s}$ [kN]	28	43	62	85	111	140	173	249	270	339	389	442	
Partial factor Rebar B500B acc. to DIN 488 ³⁾ $\gamma_{Ms,N}^{4)}$ [-]	1,4												
Installation factor													
Hammer drilling γ_{inst} [-]	1,0												
Hammer drilling with Hilti hollow drill bit TE-CD or TE-YD γ_{inst} [-]	1,0												
Diamond coring γ_{inst} [-]	1,2				1,4								
Diamond coring with roughening with Hilti Roughening tool TE-YRT γ_{inst} [-]	5)				1,0							5)	
Hammer drilling in water-filled drill holes γ_{inst} [-]	1,4												
Concrete cone failure													
Factor for cracked concrete $k_{cr,N}$ [-]	7,7												
Factor for uncracked concrete $k_{ucr,N}$ [-]	11,0												
Edge distance $c_{cr,N}$ [mm]	$1,5 \cdot h_{ef}$												
Spacing $s_{cr,N}$ [mm]	$3,0 \cdot h_{ef}$												
Splitting failure													
Edge distance $c_{cr,sp}$ [mm] for	$h/h_{ef} \geq 2,0$	$1,0 \cdot h_{ef}$											
	$2,0 > h/h_{ef} > 1,3$	$4,6 \cdot h_{ef} - 1,8 \cdot h$											
	$h/h_{ef} \leq 1,3$	$2,26 \cdot h_{ef}$											
Spacing $s_{cr,sp}$ [mm]	$2 \cdot c_{cr,sp}$												

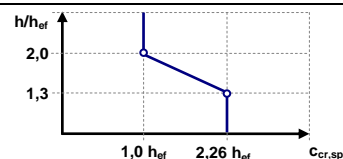

Injection system Hilti HIT-RE 500 V4

Performance
 Essential characteristics under tension load in concrete

Annex C16

Table C6: continued (1)

Reinforcing bar (rebar)	$\phi 8$	$\phi 10$	$\phi 12$	$\phi 14$	$\phi 16$	$\phi 18$	$\phi 20$	$\phi 24$	$\phi 25$	$\phi 28$	$\phi 30$	$\phi 32$	
Combined pullout and concrete cone failure for a working life of 50 years													
Characteristic resistance in uncracked concrete C20/25 in hammer drilled holes and hammer drilled holes with Hilti hollow drill bit TE-CD or TE-YD and diamond cored holes with roughening with Hilti Roughening tool TE-YRT													
Temperature range I: 24°C / 40°C $\tau_{RK,ucr}$ [N/mm ²]	10	15	15	15	15	14	14	14	14	14	13	13	
Temperature range II: 43°C / 55°C $\tau_{RK,ucr}$ [N/mm ²]	8,5	13	12	12	12	12	12	12	11	11	11	11	
Temperature range III: 55°C / 75°C $\tau_{RK,ucr}$ [N/mm ²]	3,5	5,0	5,0	5,0	4,5	4,5	4,5	4,5	4,5	4,5	4,5	4,5	
Characteristic resistance in uncracked concrete C20/25 in diamond cored holes													
Temperature range I: 24°C / 40°C $\tau_{RK,ucr}$ [N/mm ²]	9,5	9,5	9,5	9,5	9,5	9,5	9,5	9,5	9,5	10	10	10	
Temperature range II: 43°C / 55°C $\tau_{RK,ucr}$ [N/mm ²]	8,5	8,5	8,5	8,5	8,5	8,5	8,5	8,5	8,5	8,5	9,0	9,0	
Temperature range III: 55°C / 75°C $\tau_{RK,ucr}$ [N/mm ²]	4,0	4,0	4,0	4,0	4,0	4,0	4,0	4,5	4,5	4,5	4,5	4,5	
Characteristic resistance in uncracked concrete C20/25 in hammer drilled holes and installation in water-filled drill holes													
Temperature range I: 24°C / 40°C $\tau_{RK,ucr}$ [N/mm ²]	8,5	13	13	13	12	12	12	12	12	12	11	11	
Temperature range II: 43°C / 55°C $\tau_{RK,ucr}$ [N/mm ²]	7,0	11	11	10	10	10	10	10	10	9,5	9,5	9,5	
Temperature range III: 55°C / 75°C $\tau_{RK,ucr}$ [N/mm ²]	3,0	4,0	4,0	4,0	4,0	4,0	4,0	4,0	4,0	3,5	3,5	3,5	
Characteristic resistance in cracked concrete C20/25 in hammer drilled holes and hammer drilled holes with Hilti hollow drill bit TE-CD or TE-YD and diamond cored holes with roughening with Hilti Roughening tool TE-YRT													
Temperature range I: 24°C / 40°C $\tau_{RK,cr}$ [N/mm ²]	5,5	10	12	12	12	12	12	11	11	11	11	11	
Temperature range II: 43°C / 55°C $\tau_{RK,cr}$ [N/mm ²]	5,0	8,5	10	10	10	10	10	9,5	9,5	9,5	9,5	9,0	
Temperature range III: 55°C / 75°C $\tau_{RK,cr}$ [N/mm ²]	2,0	4,0	4,0	4,0	4,0	4,0	3,5	3,5	3,5	3,5	3,5	3,5	
Influence factors ψ on bond resistance τ_{rk} in cracked and uncracked concrete													
Influence of concrete strength													
in hammer drilled holes and hammer drilled holes with Hilti hollow drill bit TE-CD or TE-YD and diamond cored holes													
Temperature range I to III: ψ_c [-]	$(f_{ck}/20)^{0,1}$												
in diamond cored holes with roughening with Hilti Roughening tool TE-YRT													
Temperature range I to III: ψ_c [-]	5)					1,0					5)		
Influence of sustained load													
in hammer drilled holes and hammer drilled holes with Hilti hollow drill bit TE-CD or TE-YD and diamond cored holes with roughening with Hilti Roughening tool TE-YRT													
Temperature range I: 24°C / 40°C ψ_{sus}^0 [-]	0,88												
Temperature range II: 43°C / 55°C ψ_{sus}^0 [-]	0,72												
Temperature range III: 55°C / 75°C ψ_{sus}^0 [-]	0,69												
in diamond cored holes													
Temperature range I: 24°C / 40°C ψ_{sus}^0 [-]	0,89												
Temperature range II: 43°C / 55°C ψ_{sus}^0 [-]	0,70												
Temperature range III: 55°C / 75°C ψ_{sus}^0 [-]	0,62												

Injection system Hilti HIT-RE 500 V4

Performance

Essential characteristics under tension load in concrete

Annex C17

Table C6: continued (2)

Reinforcing bar (rebar)	φ8	φ10	φ12	φ14	φ16	φ18	φ20	φ24	φ25	φ28	φ30	φ32	
Combined pullout and concrete cone failure for a working life of 100 years													
Characteristic resistance in uncracked concrete C20/25 in hammer drilled holes and hammer drilled holes with Hilti hollow drill bit TE-CD or TE-YD and diamond cored holes with roughening with Hilti Roughening tool TE-YRT													
Temperature range I: 24°C / 40°C $\tau_{Rk,100,ucr}$ [N/mm ²]	10	15	15	15	15	14	14	14	14	14	13	13	
Temperature range II: 43°C / 55°C $\tau_{Rk,100,ucr}$ [N/mm ²]	8,0	12	12	12	12	12	12	11	11	11	11	11	
Temperature range III: 55°C / 75°C $\tau_{Rk,100,ucr}$ [N/mm ²]	3,0	5,0	5,0	5,0	4,5	4,5	4,5	4,5	4,5	4,5	4,5	4,5	
Characteristic resistance in uncracked concrete C20/25 in diamond cored holes													
Temperature range I: 24°C / 40°C $\tau_{Rk,100,ucr}$ [N/mm ²]	9,5	9,5	9,5	9,5	9,5	9,5	9,5	9,5	9,5	10	10	10	
Temperature range II: 43°C / 55°C $\tau_{Rk,100,ucr}$ [N/mm ²]	8,5	8,5	8,5	8,5	8,5	8,5	8,5	8,5	8,5	8,5	9,0	9,0	
Temperature range III: 55°C / 75°C $\tau_{Rk,100,ucr}$ [N/mm ²]	4,0	4,0	4,0	4,0	4,0	4,0	4,0	4,5	4,5	4,5	4,5	4,5	
Characteristic resistance in uncracked concrete C20/25 in hammer drilled holes and installation in water-filled drill holes													
Temperature range I: 24°C / 40°C $\tau_{Rk,100,ucr}$ [N/mm ²]	8,5	13	13	13	12	12	12	12	12	12	11	11	
Temperature range II: 43°C / 55°C $\tau_{Rk,100,ucr}$ [N/mm ²]	7,0	11	10	10	10	10	10	9,5	9,5	9,5	9,5	9,0	
Temperature range III: 55°C / 75°C $\tau_{Rk,100,ucr}$ [N/mm ²]	2,5	4,0	4,0	4,0	4,0	4,0	4,0	4,0	4,0	3,5	3,5	3,5	
Characteristic resistance in cracked concrete C20/25 in hammer drilled holes and hammer drilled holes with Hilti hollow drill bit TE-CD or TE-YD and diamond cored holes with roughening with Hilti Roughening tool TE-YRT													
Temperature range I: 24°C / 40°C $\tau_{Rk,100,cr}$ [N/mm ²]	5,0	9,0	10	10	9,5	9,5	9,5	9,0	9,0	9,0	9,0	9,0	
Temperature range II: 43°C / 55°C $\tau_{Rk,100,cr}$ [N/mm ²]	4,5	8,0	9,0	9,0	8,5	8,5	8,5	8,0	8,0	8,0	8,0	8,0	
Temperature range III: 55°C / 75°C $\tau_{Rk,100,cr}$ [N/mm ²]	2,0	4,0	4,0	4,0	4,0	4,0	3,5	3,5	3,5	3,5	3,5	3,5	
Influence factors ψ on bond resistance $\tau_{Rk,100}$ in cracked and uncracked concrete													
Influence of concrete strength													
in hammer drilled holes and hammer drilled holes with Hilti hollow drill bit TE-CD or TE-YD and diamond cored holes													
Temperature range I to III:	ψ_c	[-]		$(f_{ck}/20)^{0,1}$									
in diamond cored holes with roughening with Hilti Roughening tool TE-YRT													
Temperature range I to III:	ψ_c	[-]		5)					1,0			5)	
Influence of sustained load													
in hammer drilled holes and hammer drilled holes with Hilti hollow drill bit TE-CD or TE-YD and diamond cored holes with roughening with Hilti Roughening tool TE-YRT													
Temperature range I: 24°C / 40°C	$\psi_{sus,100}^0$	[-]		0,85									
Temperature range II: 43°C / 55°C	$\psi_{sus,100}^0$	[-]		0,72									
Temperature range III: 55°C / 75°C	$\psi_{sus,100}^0$	[-]		0,69									
in diamond cored holes													
Temperature range I: 24°C / 40°C	$\psi_{sus,100}^0$	[-]		0,70									
Temperature range II: 43°C / 55°C	$\psi_{sus,100}^0$	[-]		0,67									
Temperature range III: 55°C / 75°C	$\psi_{sus,100}^0$	[-]		0,62									

1) f_{uk} according to rebar specification.

2) Values need to be calculated acc. EAD 330499-02, Eq. 2.1, if rebars do not fulfil the requirements acc. DIN 488.

3) Values need to be calculated acc. EN 1992-4:2018, tab 4.1, if rebars do not fulfil the requirements acc. DIN 488.

4) In absence of national regulations.

5) No performance assessed.

Injection system Hilti HIT-RE 500 V4

Performance

Essential characteristics under tension load in concrete

Annex C18

Table C7: Essential characteristics for metric threaded rod according to Annex A under shear load in concrete

Metric threaded rod according to Annex A			M8	M10	M12	M16	M20	M24	M27	M30	
For a working life of 50 and 100 years											
Steel failure without lever arm											
Characteristic resistance	$V_{Rk,s}^0$	[kN]	$k_6 \cdot A_s \cdot f_{uk}$								
Factor grade 5.8	k_6	[-]	0,6								
Factor grade 6.8, 8.8	k_6	[-]	0,5								
Factor HAS A4, HAS-U A4, HIT-V-R, Threaded rod: CRC II and III (Table A2)	k_6	[-]	0,5								
Factor HAS-U HCR, HIT-V-HCR, Threaded rod: CRC V (Table A2)	k_6	[-]	0,5								
Partial factor grade 5.8, 6.8, 8.8	$\gamma_{Ms,V}^{1)}$	[-]	1,25								
Partial factor Factor HAS A4, HAS-U A4, HIT-V-R, Threaded rod: CRC II and III (Table A2)	$\gamma_{Ms,V}^{1)}$	[-]	1,56						2,38		
Partial factor HAS-U HCR, HIT-V-HCR, Threaded rod: CRC V (Table A2)	$\gamma_{Ms,V}^{1)}$	[-]	1,25				1,75				
Ductility factor	k_7	[-]	1,0								
Steel failure with lever arm											
Characteristic resistance	$M_{Rk,s}^0$	[Nm]	$1,2 \cdot W_{el} \cdot f_{uk}$								
Ductility factor	k_7	[-]	1,0								
Concrete pry-out failure											
Pry-out factor	k_8	[-]	2,0								
Concrete edge failure											
Effective length of fastener	l_f	[mm]	$\min(h_{ef}; 12 \cdot d_{nom})$							$\min(h_{ef}; 8 \cdot d_{nom}; 300)$	
Outside diameter of fastener	d_{nom}	[mm]	8	10	12	16	20	24	27	30	

¹⁾ In absence of national regulations.

Injection system Hilti HIT-RE 500 V4

Performance

Essential characteristics under shear load in concrete

Annex C19

Table C8: Essential characteristics for fractional threaded rod according to Annex A under shear load in concrete

Fractional threaded rod according to Annex A		[in.]	3/8	1/2	5/8	3/4	7/8	1	1 1/4	
For a working life of 50 and 100 years										
Steel failure without lever arm										
Characteristic resistance	$V_{Rk,s}^0$	[kN]	$k_6 \cdot A_s \cdot f_{uk}$							
Factor HIT-V	k_6	[-]	0,6							
Factor HAS-E-36	k_6	[-]	0,6							
Factor HAS-E-55	k_6	[-]	0,5							
Factor HAS-B-105	k_6	[-]	0,5							
Factor HAS-R 304	k_6	[-]	0,5							
Factor HAS-R 316	k_6	[-]	0,5							
Partial factor HIT-V	$\gamma_{Ms,V}^{1)}$	[-]	1,60							
Partial factor HAS-E-36	$\gamma_{Ms,V}^{1)}$	[-]	1,61							
Partial factor HAS-E-55	$\gamma_{Ms,V}^{1)}$	[-]	1,36							
Partial factor HAS-B-105	$\gamma_{Ms,V}^{1)}$	[-]	1,50							
Partial factor HAS-R 304	$\gamma_{Ms,V}^{1)}$	[-]	1,54				1,89		2,51	
Partial factor HAS-R 316	$\gamma_{Ms,V}^{1)}$	[-]	1,54				1,89			
Ductility factor	k_7	[-]	1,0							
Steel failure with lever arm										
Characteristic resistance	$M_{Rk,s}^0$	[Nm]	$1,2 \cdot W_{el} \cdot f_{uk}$							
Ductility factor	k_7	[-]	1,0							
Concrete pry-out failure										
Pry-out factor	k_8	[-]	2,0							
Concrete edge failure										
Effective length of fastener	l_f	[mm]	$\min(h_{ef}; 12 \cdot d_{nom})$					$\min(h_{ef}; 8 \cdot d_{nom}; 300)$		
Outside diameter of fastener	d_{nom}	[mm]	9,5	12,7	15,9	19,1	22,2	25,4	31,8	

¹⁾ In absence of national regulations.

Injection system Hilti HIT-RE 500 V4

Performance

Essential characteristics under shear load in concrete

Annex C20

Table C9: Essential characteristics for internally threaded sleeve HIS-(R)N under shear load in concrete

HIS-(R)N			M8	M10	M12	M16	M20
For a working life of 50 and 100 years							
Steel failure without lever arm							
Characteristic resistance	$V_{Rk,s}^0$	[kN]	13	23	34	63	58
Partial factor	$\gamma_{Ms,V}^{1)}$	[-]	1,25				
Characteristic resistance HIS-RN with screw grade 70	$V_{Rk,s}^0$	[kN]	13	20	30	55	83
Partial factor	$\gamma_{Ms,V}^{1)}$	[-]	1,56				
Ductility factor	k_7	[-]	1,0				
Steel failure with lever arm							
Characteristic resistance HIS-N	$M_{Rk,s}^0$	[Nm]	30	60	105	266	519
Characteristic resistance HIS-RN	$M_{Rk,s}^0$	[Nm]	26	52	92	233	454
Ductility factor	k_7	[-]	1,0				
Concrete pry-out failure							
Pry-out factor	k_8	[-]	2,0				
Concrete edge failure							
Effective length of fastener	l_f	[mm]	90	110	125	170	205
Outside diameter of fastener	d_{nom}	[mm]	12,5	16,5	20,5	25,4	27,6

¹⁾ In absence of national regulations.

Injection system Hilti HIT-RE 500 V4

Performance

Essential characteristics under shear load in concrete

Annex C21

Table C10: Essential characteristics for internally threaded sleeve HIS-(R)N under shear load in concrete

HIS-(R)N, size	[in.]	3/8	1/2	5/8	3/4
For a working life of 50 and 100 years					
Steel failure without lever arm					
Characteristic resistance HIS-N Screw acc. to SAE J429 Grade 5 or ASTM A325 (1/2 in. to 3/4 in.)	$V_{Rk,s}^0$ [kN]	21	38	60	65
Partial factor	$\gamma_{Ms,V}^{1)}$ [-]	1,50			1,25
Characteristic resistance HIS-N Screw acc. to ASTM A193 Grade B7	$V_{Rk,s}^0$ [kN]	22	40	63	65
Partial factor	$\gamma_{Ms,V}^{1)}$ [-]	1,50			1,25
Characteristic resistance HIS-RN Screw acc. to ASTM A193 Grade B8M (AISI 316)	$V_{Rk,s}^0$ [kN]	19	35	55	93
Partial factor	$\gamma_{Ms,V}^{1)}$ [-]	1,50			2,00
Characteristic resistance HIS-RN Screw acc. to ASTM A193 Grade B8T (AISI 321)	$V_{Rk,s}^0$ [kN]	22	40	63	93
Partial factor	$\gamma_{Ms,V}^{1)}$ [-]	1,50			2,00
Ductility factor	k_7 [-]	1,0			
Steel failure with lever arm					
Characteristic resistance HIS-N Screw acc. to SAE J429 Grade 5 or ASTM A325 (1/2 in. to 3/4 in.)	$M_{Rk,s}^0$ [Nm]	50	123	247	444
Characteristic resistance HIS-N Screw acc. to ASTM A193 Grade B7	$M_{Rk,s}^0$ [Nm]	52	128	257	463
Characteristic resistance HIS-RN Screw acc. to ASTM A193 Grade B8M (AISI 316)	$M_{Rk,s}^0$ [Nm]	45	113	226	407
Characteristic resistance HIS-RN Screw acc. to ASTM A193 Grade B8T (AISI 321)	$M_{Rk,s}^0$ [Nm]	52	128	257	463
Ductility factor	k_7 [-]	1,0			
Concrete pry-out failure					
Pry-out factor	k_8 [-]	2,0			
Concrete edge failure					
Effective length of fastener	l_f [mm]	110	125	170	205
Outside diameter of fastener	d_{nom} [mm]	16,5	20,5	25,4	27,6

¹⁾ In absence of national regulations.

Injection system Hilti HIT-RE 500 V4

Performance

Essential characteristics under shear load in concrete

Annex C22

Table C11: Essential characteristics for Hilti Tension anchor HZA / HZA-R under shear load in concrete

HZA / HZA-R		M12	M16	M20	M24	M27
Rebar diameter	ϕ [mm]	12	16	20	25	28
For a working life of 50 and 100 years						
Steel failure without lever arm						
Characteristic resistance HZA	$V_{Rk,S}^0$ [kN]	23	43	67	97	126
Characteristic resistance HZA-R	$V_{Rk,S}^0$ [kN]	31	55	86	124	²⁾
Partial factor	$\gamma_{Ms,V}$ ¹⁾ [-]	1,5				
Ductility factor	k_7 [-]	1,0				
Steel failure with lever arm						
Characteristic resistance HZA	$M_{Rk,S}^0$ [Nm]	72	183	357	617	915
Characteristic resistance HZA-R	$M_{Rk,S}^0$ [Nm]	97	234	457	790	²⁾
Ductility factor	k_7 [-]	1,0				
Concrete pry-out failure						
Pry-out factor	k_8 [-]	2,0				
Concrete edge failure						
Effective length of fastener	l_f [mm]	$\min(h_{ef}; 12 \cdot d_{nom})$			$\min(h_{ef}; 8 \cdot d_{nom}; 300)$	
Outside diameter of fastener	d_{nom} [mm]	12	16	20	24	27

¹⁾ In absence of national regulations.

²⁾ No performance assessed.

Injection system Hilti HIT-RE 500 V4

Performance

Essential characteristics under shear load in concrete

Annex C23

Table C12: Essential characteristics for reinforcing bars (rebars) under shear load in concrete

Reinforcing bar (rebar)	$\phi 8$	$\phi 10$	$\phi 12$	$\phi 14$	$\phi 16$	$\phi 18$	$\phi 20$	$\phi 24$	$\phi 25$	$\phi 28$	$\phi 30$	$\phi 32$		
For a working life of 50 and 100 years														
Steel failure without lever arm														
Characteristic resistance	$V_{Rk,s}^0$	[kN]	$0,5 \cdot A_s \cdot f_{uk}^{1)}$											
Characteristic resistance Rebar B500B acc. to DIN 488 ²⁾	$V_{Rk,s}^0$	[kN]	14	22	31	42	55	70	86	124	135	169	194	221
Partial factor Rebar B500B acc. to DIN 488 ³⁾	$\gamma_{Ms,V}^{4)}$	[-]	1,5											
Ductility factor	k_7	[-]	1,0											
Steel failure with lever arm														
Characteristic resistance	$M_{Rk,s}^0$	[Nm]	$1,2 \cdot W_{el} \cdot f_{uk}^{1)}$											
Characteristic resistance Rebar B500B acc. to DIN 488	$M_{Rk,s}^0$	[Nm]	33	65	112	178	265	378	518	896	1012	1422	1749	2123
Ductility factor	k_7	[-]	1,0											
Concrete pry-out failure														
Pry-out factor	k_8	[-]	2,0											
Concrete edge failure														
Effective length of fastener	l_f	[mm]	$\min(h_{ef}; 12 \cdot d_{nom})$							$\min(h_{ef}; 8 \cdot d_{nom}; 300)$				
Outside diameter of fastener	d_{nom}	[mm]	8	10	12	14	16	18	20	24	25	28	30	32

- 1) f_{uk} according to rebar specification.
- 2) Values need to be calculated acc. EAD 330499-02, Eq. 2.1, if rebars do not fulfil the requirements acc. DIN 488.
- 3) Values need to be calculated acc. EN 1992-4:2018, tab 4.1, if rebars do not fulfil the requirements acc. DIN 488.
- 4) In absence of national regulations.

Injection system Hilti HIT-RE 500 V4

Performance
 Essential characteristics under shear load in concrete

Annex C24

Table C13: Displacements for threaded rod under tension load in concrete

Threaded rod, HAS-U-..., HIT-V-..., AM...8.8	M8	M10	M12	M16	M20	M24	M27	M30	
Threaded rod, HAS-..., HIT-V, size [in.]	-	3/8	1/2	5/8	3/4	7/8	1	1 1/4	
Displacement in uncracked concrete									
Temperature range I: 24°C / 40°C	δ_{N0} [mm/(N/mm ²)]	0,04	0,05	0,05	0,06	0,06	0,07	0,08	0,08
	$\delta_{N\infty}$ [mm/(N/mm ²)]	0,10	0,11	0,12	0,13	0,15	0,17	0,18	0,19
Temperature range II: 43°C / 55°C	δ_{N0} [mm/(N/mm ²)]	0,05	0,05	0,06	0,07	0,07	0,08	0,09	0,10
	$\delta_{N\infty}$ [mm/(N/mm ²)]	0,12	0,13	0,14	0,16	0,18	0,20	0,21	0,23
Temperature range III: 55°C / 75°C	δ_{N0} [mm/(N/mm ²)]	0,05	0,06	0,06	0,07	0,08	0,09	0,09	0,10
	$\delta_{N\infty}$ [mm/(N/mm ²)]	0,12	0,13	0,15	0,17	0,19	0,21	0,23	0,24
Displacement in cracked concrete									
Temperature range I: 24°C / 40°C	δ_{N0} [mm/(N/mm ²)]	0,02	0,03	0,05	0,08	0,10	0,13	0,15	0,18
	$\delta_{N\infty}$ [mm/(N/mm ²)]	0,12	0,19	0,14	0,19	0,16	0,16	0,15	0,18
Temperature range II: 43°C / 55°C	δ_{N0} [mm/(N/mm ²)]	0,02	0,04	0,06	0,09	0,12	0,16	0,18	0,21
	$\delta_{N\infty}$ [mm/(N/mm ²)]	0,15	0,23	0,17	0,23	0,19	0,19	0,18	0,21
Temperature range III: 55°C / 75°C	δ_{N0} [mm/(N/mm ²)]	0,02	0,04	0,06	0,10	0,13	0,17	0,19	0,22
	$\delta_{N\infty}$ [mm/(N/mm ²)]	0,16	0,24	0,18	0,24	0,20	0,20	0,19	0,22

Table C14: Displacements for internally threaded HIS-(R)N under tension load in concrete

HIS-(R)N	M8	M10	M12	M16	M20	
HIS-(R)N, size [in.]	-	3/8	1/2	5/8	3/4	
Displacement in uncracked concrete						
Temperature range I: 24°C / 40°C	δ_{N0} [mm/(N/mm ²)]	0,05	0,06	0,06	0,07	0,08
	$\delta_{N\infty}$ [mm/(N/mm ²)]	0,12	0,13	0,15	0,17	0,18
Temperature range II: 43°C / 55°C	δ_{N0} [mm/(N/mm ²)]	0,06	0,07	0,07	0,08	0,09
	$\delta_{N\infty}$ [mm/(N/mm ²)]	0,14	0,16	0,18	0,20	0,21
Temperature range III: 55°C / 75°C	δ_{N0} [mm/(N/mm ²)]	0,06	0,07	0,07	0,09	0,10
	$\delta_{N\infty}$ [mm/(N/mm ²)]	0,15	0,16	0,19	0,21	0,22
Displacement in cracked concrete						
Temperature range I: 24°C / 40°C	δ_{N0} [mm/(N/mm ²)]	0,02	0,03	0,05	0,08	0,10
	$\delta_{N\infty}$ [mm/(N/mm ²)]	0,12	0,19	0,14	0,19	0,16
Temperature range II: 43°C / 55°C	δ_{N0} [mm/(N/mm ²)]	0,02	0,04	0,06	0,09	0,12
	$\delta_{N\infty}$ [mm/(N/mm ²)]	0,15	0,23	0,17	0,23	0,19
Temperature range III: 55°C / 75°C	δ_{N0} [mm/(N/mm ²)]	0,02	0,04	0,06	0,10	0,13
	$\delta_{N\infty}$ [mm/(N/mm ²)]	0,16	0,24	0,18	0,24	0,20

Injection system Hilti HIT-RE 500 V4

Performance
Displacements under tension load in concrete

Annex C25

Table C15: Displacements for Hilti Tension anchor HZA / HZA-R under tension load in concrete

HZA / HZA-R		M12	M16	M20	M24	M27
Rebar diameter	ϕ [mm]	12	16	20	25	28
Displacement in uncracked concrete						
Temperature range I: 24°C / 40°C	δ_{N0} [mm/(N/mm ²)]	0,05	0,06	0,07	0,07	0,08
	$\delta_{N\infty}$ [mm/(N/mm ²)]	0,12	0,15	0,17	0,18	0,19
Temperature range II: 43°C / 55°C	δ_{N0} [mm/(N/mm ²)]	0,06	0,07	0,09	0,09	0,09
	$\delta_{N\infty}$ [mm/(N/mm ²)]	0,14	0,18	0,20	0,21	0,22
Temperature range III: 55°C / 75°C	δ_{N0} [mm/(N/mm ²)]	0,07	0,08	0,09	0,09	0,10
	$\delta_{N\infty}$ [mm/(N/mm ²)]	0,15	0,19	0,22	0,22	0,23
Displacement in cracked concrete						
Temperature range I: 24°C / 40°C	δ_{N0} [mm/(N/mm ²)]	0,06	0,10	0,14	0,15	0,16
	$\delta_{N\infty}$ [mm/(N/mm ²)]	0,06	0,16	0,16	0,15	0,16
Temperature range II: 43°C / 55°C	δ_{N0} [mm/(N/mm ²)]	0,07	0,12	0,17	0,17	0,19
	$\delta_{N\infty}$ [mm/(N/mm ²)]	0,07	0,19	0,19	0,18	0,19
Temperature range III: 55°C / 75°C	δ_{N0} [mm/(N/mm ²)]	0,08	0,13	0,17	0,18	0,20
	$\delta_{N\infty}$ [mm/(N/mm ²)]	0,08	0,20	0,20	0,19	0,20

Table C16: Displacements for reinforcing bar (rebar) under tension load in concrete

Reinforcing bar (rebar)		$\phi 8$	$\phi 10$	$\phi 12$	$\phi 14$	$\phi 16$	$\phi 18$
Displacement in uncracked concrete							
Temperature range I: 24°C / 40°C	δ_{N0} [mm/(N/mm ²)]	0,04	0,05	0,05	0,06	0,06	0,07
	$\delta_{N\infty}$ [mm/(N/mm ²)]	0,10	0,11	0,12	0,13	0,15	0,16
Temperature range II: 43°C / 55°C	δ_{N0} [mm/(N/mm ²)]	0,05	0,05	0,06	0,07	0,07	0,08
	$\delta_{N\infty}$ [mm/(N/mm ²)]	0,12	0,13	0,14	0,16	0,18	0,19
Temperature range III: 55°C / 75°C	δ_{N0} [mm/(N/mm ²)]	0,05	0,06	0,07	0,07	0,08	0,08
	$\delta_{N\infty}$ [mm/(N/mm ²)]	0,12	0,13	0,15	0,17	0,19	0,21
Displacement in cracked concrete							
Temperature range I: 24°C / 40°C	δ_{N0} [mm/(N/mm ²)]	0,02	0,03	0,06	0,08	0,10	0,11
	$\delta_{N\infty}$ [mm/(N/mm ²)]	0,12	0,19	0,06	0,19	0,16	0,16
Temperature range II: 43°C / 55°C	δ_{N0} [mm/(N/mm ²)]	0,02	0,04	0,07	0,09	0,12	0,14
	$\delta_{N\infty}$ [mm/(N/mm ²)]	0,15	0,23	0,07	0,23	0,19	0,19
Temperature range III: 55°C / 75°C	δ_{N0} [mm/(N/mm ²)]	0,02	0,04	0,08	0,10	0,13	0,14
	$\delta_{N\infty}$ [mm/(N/mm ²)]	0,16	0,24	0,08	0,24	0,20	0,20

Injection system Hilti HIT-RE 500 V4

Performance
Displacements under tension load in concrete

Annex C26

Table C17: Displacements for reinforcing bar (rebar) under tension load in concrete

Reinforcing bar (rebar)		$\phi 20$	$\phi 24$	$\phi 25$	$\phi 28$	$\phi 30$	$\phi 32$
Displacement in uncracked concrete							
Temperature range I: 24°C / 40°C	δ_{N0} [mm/(N/mm ²)]	0,07	0,07	0,07	0,08	0,08	0,08
	$\delta_{N\infty}$ [mm/(N/mm ²)]	0,17	0,19	0,18	0,19	0,19	0,20
Temperature range II: 43°C / 55°C	δ_{N0} [mm/(N/mm ²)]	0,09	0,08	0,09	0,09	0,10	0,10
	$\delta_{N\infty}$ [mm/(N/mm ²)]	0,20	0,21	0,21	0,22	0,23	0,24
Temperature range III: 55°C / 75°C	δ_{N0} [mm/(N/mm ²)]	0,09	0,09	0,09	0,10	0,10	0,11
	$\delta_{N\infty}$ [mm/(N/mm ²)]	0,22	0,22	0,22	0,23	0,24	0,25
Displacement in cracked concrete							
Temperature range I: 24°C / 40°C	δ_{N0} [mm/(N/mm ²)]	0,14	0,15	0,15	0,16	0,18	0,19
	$\delta_{N\infty}$ [mm/(N/mm ²)]	0,16	0,16	0,15	0,16	0,18	0,19
Temperature range II: 43°C / 55°C	δ_{N0} [mm/(N/mm ²)]	0,17	0,17	0,17	0,19	0,21	0,22
	$\delta_{N\infty}$ [mm/(N/mm ²)]	0,19	0,19	0,18	0,19	0,21	0,22
Temperature range III: 55°C / 75°C	δ_{N0} [mm/(N/mm ²)]	0,17	0,18	0,18	0,20	0,22	0,24
	$\delta_{N\infty}$ [mm/(N/mm ²)]	0,20	0,20	0,19	0,20	0,22	0,24

Injection system Hilti HIT-RE 500 V4

Performance
 Displacements under tension load in concrete

Annex C27

Table C18: Displacements for threaded rod under shear load in concrete

Metric threaded rod according to Annex A		M8	M10	M12	M16	M20	M24	M27	M30
Fractional threaded rod according to Annex A	[in.]	-	3/8	1/2	5/8	3/4	7/8	1	1 1/4
Displacement	δ_{V0}	[mm/kN]	0,06	0,06	0,05	0,04	0,04	0,03	0,03
	$\delta_{V\infty}$	[mm/kN]	0,09	0,08	0,08	0,06	0,06	0,05	0,05

Table C19: Displacements for internally threaded HIS-(R)N under shear load in concrete

HIS-(R)N		M8	M10	M12	M16	M20
HIS-(R)N, size	[in.]	-	3/8	1/2	5/8	3/4
Displacement	δ_{V0}	[mm/kN]	0,06	0,06	0,05	0,04
	$\delta_{V\infty}$	[mm/kN]	0,09	0,08	0,08	0,06

Table C20: Displacements for Hilti Tension anchor HZA / HZA-R under shear load in concrete

HZA / HZA-R		M12	M16	M20	M24	M27
Displacement	δ_{V0}	[mm/kN]	0,05	0,04	0,04	0,03
	$\delta_{V\infty}$	[mm/kN]	0,08	0,06	0,06	0,05

Table C21: Displacements for reinforcing bar (rebar) under shear load in concrete

Reinforcing bar (rebar)		$\phi 10$	$\phi 12$	$\phi 14$	$\phi 16$	$\phi 18$	$\phi 20$
Displacement	δ_{V0}	[mm/kN]	0,05	0,05	0,05	0,04	0,04
	$\delta_{V\infty}$	[mm/kN]	0,08	0,08	0,07	0,06	0,06

Table C22: Displacements for reinforcing bar (rebar) under shear load in concrete

Reinforcing bar (rebar)		$\phi 24$	$\phi 25$	$\phi 28$	$\phi 30$	$\phi 32$	$\phi 24$
Displacement	δ_{V0}	[mm/kN]	0,04	0,03	0,03	0,03	0,03
	$\delta_{V\infty}$	[mm/kN]	0,05	0,05	0,05	0,05	0,04

Injection system Hilti HIT-RE 500 V4

Performance
 Displacements under shear load in concrete

Annex C28

Table C23: Essential characteristics for metric threaded rod according Annex A under tension load for seismic category C1 in concrete

Metric threaded rod according to Annex A	M8	M10	M12	M16	M20	M24	M27	M30	
For a working life of 50 and 100 years									
Steel failure									
Characteristic resistance	$N_{Rk,s,C1}$ [kN]			$A_s \cdot f_{uk}$					
Combined pullout and concrete cone failure for a working life of 50 years									
Characteristic resistance in cracked concrete C20/25 in hammer drilled holes and hammer drilled holes with Hilti hollow drill bit TE-CD or TE-YD and diamond cored holes with roughening with Hilti Roughening tool TE-YRT									
Temperature range I: 24°C / 40°C	$\tau_{Rk,C1}$ [N/mm ²]	6,8	8,2	10,1	10,5	9,7	9,4	9,0	8,5
Temperature range II: 43°C / 55°C	$\tau_{Rk,C1}$ [N/mm ²]	6,3	7,3	8,3	8,1	7,8	7,9	7,5	7,0
Temperature range III: 55°C / 75°C	$\tau_{Rk,C1}$ [N/mm ²]	3,6	3,2	3,2	3,3	2,9	3,0	3,0	3,0
Combined pullout and concrete cone failure for a working life of 100 years									
Characteristic resistance in cracked concrete C20/25 in hammer drilled holes and hammer drilled holes with Hilti hollow drill bit TE-CD or TE-YD and diamond cored holes with roughening with Hilti Roughening tool TE-YRT									
Temperature range I: 24°C / 40°C	$\tau_{Rk,100,C1}$ [N/mm ²]	6,3	7,3	8,3	8,1	7,8	7,4	7,0	6,5
Temperature range II: 43°C / 55°C	$\tau_{Rk,100,C1}$ [N/mm ²]	5,4	6,4	7,4	7,1	6,8	6,4	6,5	6,0
Temperature range III: 55°C / 75°C	$\tau_{Rk,100,C1}$ [N/mm ²]	3,6	3,2	3,2	3,3	2,9	3,0	3,0	3,0
Influence factors ψ on bond resistance $\tau_{Rk,C1}$ and $\tau_{Rk,100,C1}$									
Influence of concrete strength									
Temperature range I to III:	ψ_c [-]							1,0	

Table C24: Essential characteristics for fractional threaded rod according Annex A under tension load for seismic category C1 in concrete

Fractional threaded rod according to Annex A [in.]	3/8	1/2	5/8	3/4	7/8	1	1 1/4	
For a working life of 50 and 100 years								
Steel failure								
Characteristic resistance	$N_{Rk,s,C1}$ [kN]			$A_s \cdot f_{uk}$				
Combined pullout and concrete cone failure for a working life of 50 years								
Characteristic resistance in cracked concrete C20/25 in hammer drilled holes and hammer drilled holes with Hilti hollow drill bit TE-CD or TE-YD and diamond cored holes with roughening with Hilti Roughening tool TE-YRT								
Temperature range I: 24°C / 40°C	$\tau_{Rk,C1}$ [N/mm ²]	8,2	10,1	10,5	9,7	8,9	9,0	8,5
Temperature range II: 43°C / 55°C	$\tau_{Rk,C1}$ [N/mm ²]	7,3	8,3	8,1	8,2	7,9	7,5	7,0
Temperature range III: 55°C / 75°C	$\tau_{Rk,C1}$ [N/mm ²]	3,2	3,2	3,3	2,9	3,0	3,0	2,5
Combined pullout and concrete cone failure for a working life of 100 years								
Characteristic resistance in cracked concrete C20/25 in hammer drilled holes and hammer drilled holes with Hilti hollow drill bit TE-CD or TE-YD and diamond cored holes with roughening with Hilti Roughening tool TE-YRT								
Temperature range I: 24°C / 40°C	$\tau_{Rk,100,C1}$ [N/mm ²]	7,3	7,8	8,1	7,8	7,4	7,5	6,5
Temperature range II: 43°C / 55°C	$\tau_{Rk,100,C1}$ [N/mm ²]	6,4	6,9	7,1	6,8	6,9	6,5	6,0
Temperature range III: 55°C / 75°C	$\tau_{Rk,100,C1}$ [N/mm ²]	3,2	3,2	3,3	2,9	3,0	3,0	2,5
Influence factors ψ on bond resistance $\tau_{Rk,C1}$ and $\tau_{Rk,100,C1}$								
Influence of concrete strength								
Temperature range I to III:	ψ_c [-]						1,0	

Injection system Hilti HIT-RE 500 V4

Performance

Essential characteristics under tension load for seismic performance category C1 in concrete

Annex C29

Table C25: Essential characteristics for internally threaded sleeve HIS-(R)N under tension load for seismic category C1 in concrete

HIS-(R)N	M8	M10	M12	M16	M20
For a working life of 50 and 100 years					
Steel failure					
Characteristic resistance HIS-N $N_{Rk,s,C1}$ [kN]	25	46	67	125	116
Characteristic resistance HIS-RN $N_{Rk,s,C1}$ [kN]	26	41	59	110	166
Combined pullout and concrete cone failure for a working life of 50 years					
Characteristic resistance in cracked concrete C20/25 in hammer drilled holes and hammer drilled holes with Hilti hollow drill bit TE-CD or TE-YD and diamond cored holes with roughening with Hilti Roughening tool TE-YRT					
Temperature range I: 24°C / 40°C $\tau_{Rk,C1}$ [N/mm ²]	8,4	8,6	8,7	9,0	9,0
Temperature range II: 43°C / 55°C $\tau_{Rk,C1}$ [N/mm ²]	7,4	7,6	7,8	8,0	8,0
Temperature range III: 55°C / 75°C $\tau_{Rk,C1}$ [N/mm ²]	2,8	3,3	3,4	3,5	3,5
Combined pullout and concrete cone failure for a working life of 100 years					
Characteristic resistance in cracked concrete C20/25 in hammer drilled holes and hammer drilled holes with Hilti hollow drill bit TE-CD or TE-YD and diamond cored holes with roughening with Hilti Roughening tool TE-YRT					
Temperature range I: 24°C / 40°C $\tau_{Rk,100,C1}$ [N/mm ²]	6,5	6,7	6,8	7,0	7,0
Temperature range II: 43°C / 55°C $\tau_{Rk,100,C1}$ [N/mm ²]	5,6	6,2	6,3	6,5	6,5
Temperature range III: 55°C / 75°C $\tau_{Rk,100,C1}$ [N/mm ²]	2,8	2,9	2,9	3,0	3,0
Influence factors ψ on bond resistance $\tau_{Rk,C1}$ and $\tau_{Rk,100,C1}$					
Influence of concrete strength					
Temperature range I to III: ψ_c [-]	1,0				

Injection system Hilti HIT-RE 500 V4

Performance

Essential characteristics under tension load for seismic performance category C1 in concrete

Annex C30

Table C26: Essential characteristics for threaded rod under tension load for seismic category C1 in concrete

HIS-(R)N, size	[in.]	3/8	1/2	5/8	3/4	
For a working life of 50 and 100 years						
Steel failure						
Characteristic resistance HIS-N Screw acc. to SAE J429 Grade 5 or ASTM A325 (1/2 in. to 3/4 in.)	$N_{Rk,s,C1}$	[kN]	41	76	121	130
Characteristic resistance HIS-N Screw acc. to ASTM A193 Grade B7	$N_{Rk,s,C1}$	[kN]	43	77	128	130
Characteristic resistance HIS-RN Screw acc. to ASTM A193 Grade B8M (AISI 316)	$N_{Rk,s,C1}$	[kN]	38	110	182	185
Characteristic resistance HIS-RN Screw acc. to ASTM A193 Grade B8T (AISI 321)	$N_{Rk,s,C1}$	[kN]	43	110	182	185
Combined pullout and concrete cone failure for a working life of 50 years						
Characteristic resistance in cracked concrete C20/25 in hammer drilled holes and hammer drilled holes with Hilti hollow drill bit TE-CD or TE-YD and diamond cored holes with roughening with Hilti Roughening tool TE-YRT						
Temperature range I: 24°C / 40°C	$\tau_{Rk,C1}$	[N/mm ²]	8,6	8,7	9,0	9,0
Temperature range II: 43°C / 55°C	$\tau_{Rk,C1}$	[N/mm ²]	7,6	7,8	8,0	8,0
Temperature range III: 55°C / 75°C	$\tau_{Rk,C1}$	[N/mm ²]	2,9	2,9	3,0	3,0
Combined pullout and concrete cone failure for a working life of 100 years						
Characteristic resistance in cracked concrete C20/25 in hammer drilled holes and hammer drilled holes with Hilti hollow drill bit TE-CD or TE-YD and diamond cored holes with roughening with Hilti Roughening tool TE-YRT						
Temperature range I: 24°C / 40°C	$\tau_{Rk,100,C1}$	[N/mm ²]	6,7	6,8	7,0	7,0
Temperature range II: 43°C / 55°C	$\tau_{Rk,100,C1}$	[N/mm ²]	6,2	6,3	6,5	6,5
Temperature range III: 55°C / 75°C	$\tau_{Rk,100,C1}$	[N/mm ²]	2,9	2,9	3,0	3,0
Influence factors ψ on bond resistance $\tau_{Rk,C1}$ and $\tau_{Rk,100,C1}$						
Influence of concrete strength						
Temperature range I to III:	ψ_c	[-]				1,0

Injection system Hilti HIT-RE 500 V4

Performance

Essential characteristics under tension load for seismic performance category C1 in concrete

Annex C31

Table C27: Essential characteristics for Hilti Tension anchor HZA / HZA-R under tension load for seismic category C1 in concrete

HZA / HZA-R		M12	M16	M20	M24	M27
Rebar diameter	ϕ [mm]	12	16	20	25	28
For a working life of 50 and 100 years						
Steel failure						
Characteristic resistance HZA	$N_{Rk,s,C1}$ [kN]	46	86	135	194	253
Characteristic resistance HZA-R	$N_{Rk,s,C1}$ [kN]	62	111	173	248	1)
Combined pullout and concrete cone failure for a working life of 50 years						
Characteristic resistance in cracked concrete C20/25 in hammer drilled holes and hammer drilled holes with Hilti hollow drill bit TE-CD or TE-YD and diamond cored holes with roughening with Hilti Roughening tool TE-YRT						
Temperature range I:	24°C / 40°C $\tau_{Rk,C1}$ [N/mm ²]	11,0	11,4	11,6	10,9	11,0
Temperature range II:	43°C / 55°C $\tau_{Rk,C1}$ [N/mm ²]	9,2	9,5	9,7	9,4	9,5
Temperature range III:	55°C / 75°C $\tau_{Rk,C1}$ [N/mm ²]	3,7	3,8	3,4	3,5	3,5
Combined pullout and concrete cone failure for a working life of 100 years						
Characteristic resistance in cracked concrete C20/25 in hammer drilled holes and hammer drilled holes with Hilti hollow drill bit TE-CD or TE-YD and diamond cored holes with roughening with Hilti Roughening tool TE-YRT						
Temperature range I:	24°C / 40°C $\tau_{Rk,100,C1}$ [N/mm ²]	9,2	9,0	9,2	8,9	9,0
Temperature range II:	43°C / 55°C $\tau_{Rk,100,C1}$ [N/mm ²]	8,3	8,1	8,2	7,9	8,0
Temperature range III:	55°C / 75°C $\tau_{Rk,100,C1}$ [N/mm ²]	3,7	3,8	3,4	3,5	3,5
Influence factors ψ on bond resistance $\tau_{Rk,C1}$ and $\tau_{Rk,100,C1}$						
Influence of concrete strength						
Temperature range I to III:	ψ_c [-]	1,0				

1) No performance assessed.

Injection system Hilti HIT-RE 500 V4

Performance

Essential characteristics under tension load for seismic performance category C1 in concrete

Annex C32

Table C28: Essential characteristics for reinforcing bars (rebars) under tension load for seismic category C1 in concrete

Reinforcing bar (rebar)	$\phi 10$	$\phi 12$	$\phi 14$	$\phi 16$	$\phi 18$	$\phi 20$	$\phi 24$	$\phi 25$	$\phi 28$	$\phi 30$	$\phi 32$
For a working life of 50 and 100 years											
Steel failure											
Characteristic resistance $N_{Rk,s,C1}$ [kN]	$A_s \cdot f_{uk}^{1)}$										
Characteristic resistance Rebar B500B acc. to DIN 488 ²⁾ $N_{Rk,s,C1}$ [kN]	43	62	85	111	140	173	249	270	339	389	442
Combined pullout and concrete cone failure for a working life of 50 years											
Characteristic resistance in cracked concrete C20/25 in hammer drilled holes and hammer drilled holes with Hilti hollow drill bit TE-CD or TE-YD and diamond cored holes with roughening with Hilti Roughening tool TE-YRT											
Temperature range I: 24°C / 40°C $\tau_{Rk,C1}$ [N/mm ²]	9,1	11,0	11,0	11,4	11,5	11,6	10,8	10,9	11,0	11,0	11,0
Temperature range II: 43°C / 55°C $\tau_{Rk,C1}$ [N/mm ²]	7,7	9,2	9,2	9,5	9,6	9,7	9,3	9,4	9,5	9,5	9,0
Temperature range III: 55°C / 75°C $\tau_{Rk,C1}$ [N/mm ²]	3,6	3,7	3,7	3,8	3,8	3,4	3,4	3,5	3,5	3,5	3,5
Combined pullout and concrete cone failure for a working life of 100 years											
Characteristic resistance in cracked concrete C20/25 in hammer drilled holes and hammer drilled holes with Hilti hollow drill bit TE-CD or TE-YD and diamond cored holes with roughening with Hilti Roughening tool TE-YRT											
Temperature range I: 24°C / 40°C $\tau_{Rk,100,C1}$ [N/mm ²]	8,2	9,2	9,2	9,0	9,1	9,2	8,8	8,9	9,0	9,0	9,0
Temperature range II: 43°C / 55°C $\tau_{Rk,100,C1}$ [N/mm ²]	7,3	8,3	8,3	8,1	8,2	8,2	7,8	7,9	8,0	8,0	8,0
Temperature range III: 55°C / 75°C $\tau_{Rk,100,C1}$ [N/mm ²]	3,6	3,7	3,7	3,8	3,8	3,4	3,4	3,5	3,5	3,5	3,5
Influence factors ψ on bond resistance $\tau_{Rk,C1}$ and $\tau_{Rk,100,C1}$											
Influence of concrete strength											
Temperature range I to III: ψ_c [-]	1,0										

¹⁾ f_{uk} according to rebar specification.

²⁾ Values need to be calculated acc. EAD 330499-02, Eq. 2.1, if rebars do not fulfil the requirements acc. DIN 488.

Injection system Hilti HIT-RE 500 V4

Performance

Essential characteristics under tension load for seismic performance category C1 in concrete

Annex C33

Table C29: Essential characteristics for metric threaded rod according Annex A under shear load for seismic category C1 in concrete

Threaded rod, HAS-U-..., HIT-V-..., AM...8.8	M8	M10	M12	M16	M20	M24	M27	M30	
For a working life of 50 and 100 years									
Annular gap factor without Hilti Filling Set α_{gap}	[-] 0,5								
Annular gap factor with Hilti Filling Set α_{gap}	[-] 1,0							1)	
Steel failure without lever arm									
Characteristic resistance HAS 5.8, HAS-U-5.8, HIT-V-5.8	$V_{Rk,s,C1}$	[kN]	0,6 · A_s · f_{uk}						
Characteristic resistance HAS 8.8, HAS-U-8.8., HIT-V-8.8, AM...8.8	$V_{Rk,s,C1}$	[kN]	0,5 · A_s · f_{uk}						
Characteristic resistance Commercial standard threaded rod	$V_{Rk,s,C1}$	[kN]	0,35 · A_s · f_{uk}						

1) No performance assessed.

Table C30: Essential characteristics for fractional threaded rod according Annex A under shear load for seismic category C1 in concrete

Threaded rod, HAS-..., HIT-V, size	[in.]	3/8	1/2	5/8	3/4	7/8	1	1 1/4	
For a working life of 50 and 100 years									
Annular gap factor without Hilti Filling Set α_{gap}	[-] 0,5								
Steel failure without lever arm									
Characteristic resistance HAS-..., HIT-V	$V_{Rk,s,C1}$	[kN]	0,5 · A_s · f_{uk}						
Characteristic resistance Commercial standard threaded rod	$V_{Rk,s,C1}$	[kN]	0,35 · A_s · f_{uk}						

Table C31: Essential characteristics for internally threaded sleeve HIS-(R)N under shear load for seismic category C1 in concrete

HIS-(R)N	M8	M10	M12	M16	M20		
For a working life of 50 and 100 years							
Annular gap factor without Hilti Filling Set α_{gap}	[-] 0,5						
Annular gap factor with Hilti Filling Set α_{gap}	[-] 1,0						
Steel failure without lever arm							
Characteristic resistance HIS-N with screw 8.8	$V_{Rk,s,C1}$	[kN]	9,0	16	27	41	39
Characteristic resistance HIS-RN with screw grade 70	$V_{Rk,s,C1}$	[kN]	9,0	14	21	39	58

Injection system Hilti HIT-RE 500 V4

Performance

Essential characteristics under shear load for seismic performance category C1 in concrete

Annex C34

Table C32: Essential characteristics for internally threaded sleeve HIS-(R)N under shear load for seismic category C1 in concrete

HIS-(R)N, size	[in.]	3/8	1/2	5/8	3/4	
For a working life of 50 and 100 years						
Annular gap factor without Hilti Filling Set	α_{gap}	[-]				0,5
Steel failure without lever arm						
Characteristic resistance HIS-N Screw acc. to SAE J429 Grade 5 or ASTM A325 (1/2 in. to 3/4 in.)	$V_{Rk,s,C1}$	[kN]	14	27	42	45
Characteristic resistance HIS-N Screw acc. to ASTM A193 Grade B7	$V_{Rk,s,C1}$	[kN]	15	28	44	45
Characteristic resistance HIS-RN Screw acc. to ASTM A193 Grade B8M (AISI 316)	$V_{Rk,s,C1}$	[kN]	13	24	39	65
Characteristic resistance HIS-RN Screw acc. to ASTM A193 Grade B8T (AISI 321)	$V_{Rk,s,C1}$	[kN]	15	28	44	65

Table C33: Essential characteristics for Hilti Tension anchor HZA / HZA-R under shear load for seismic category C1 in concrete

HZA / HZA-R		M12	M16	M20	M24	M27	
For a working life of 50 and 100 years							
Annular gap factor without Hilti Filling Set	α_{gap}	[-]					0,5
Steel failure without lever arm							
Characteristic resistance HZA	$V_{Rk,s,C1}$	[kN]	23	43	67	97	126
Characteristic resistance HZA-R	$V_{Rk,s,C1}$	[kN]	31	55	86	124	¹⁾

¹⁾ No performance assessed.

Table C34: Essential characteristics for reinforcing bars (rebars) under shear load for seismic category C1 in concrete

Reinforcing bar (rebar)		$\phi 10$	$\phi 12$	$\phi 14$	$\phi 16$	$\phi 18$	$\phi 20$	$\phi 24$	$\phi 25$	$\phi 28$	$\phi 30$	$\phi 32$	
For a working life of 50 and 100 years													
Steel failure without lever arm													
Characteristic resistance	$V_{Rk,s,C1}$	[kN]	$0,35 \cdot A_s \cdot f_{uk}$ ¹⁾										
Characteristic resistance Rebar B500B acc. to DIN 488 ²⁾	$V_{Rk,s,C1}$	[kN]	15	22	30	39	49	60	87	95	118	136	155

¹⁾ f_{uk} according to rebar specification.

²⁾ Values need to be calculated acc. EAD 330499-02, Eq. 2.1, if rebars do not fulfil the requirements acc. DIN 488.

Injection system Hilti HIT-RE 500 V4

Performance

Essential characteristics under shear load for seismic performance category C1 in concrete

Annex C35

Table C35: Essential characteristics for metric threaded rod according Annex A under tension load for seismic category C2 in concrete

Metric threaded rod according Annex A	M12	M16	M20	M24	M27	M30	
For a working life of 50 and 100 years							
Steel failure							
Characteristic resistance HAS (8.8, 8.8 HDG, A4), HAS-U (8.8, 8.8 HDG, A4, HCR), HIT-V (-8.8, -8.8F, -R, -HCR), AM (8.8, 8.8 HDG), Threaded rod (electroplated zinc coated 8.8, CRC II, CRC III and CRC V, see Table A1)	$N_{Rk,s,C2}$ [kN]		$A_s \cdot f_{uk}$				
Combined pullout and concrete cone failure for a working life of 50 years							
Characteristic resistance in cracked concrete C20/25 in hammer drilled holes and hammer drilled holes with Hilti hollow drill bit TE-CD or TE-YD							
Temperature range I: 24°C / 40°C	$\tau_{Rk,C2}$ [N/mm ²]	3,7	6,5	5,8	6,0	5,0	5,2
Temperature range II: 43°C / 55°C	$\tau_{Rk,C2}$ [N/mm ²]	3,1	5,3	4,8	5,0	4,2	4,3
Temperature range III: 55°C / 75°C	$\tau_{Rk,C2}$ [N/mm ²]	1,2	2,1	1,9	1,9	1,6	1,7
Combined pullout and concrete cone failure for a working life of 100 years							
Characteristic resistance in cracked concrete C20/25 in hammer drilled holes and hammer drilled holes with Hilti hollow drill bit TE-CD or TE-YD							
Temperature range I: 24°C / 40°C	$\tau_{Rk,100,C2}$ [N/mm ²]	3,7	6,5	5,8	6,0	5,0	5,2
Temperature range II: 43°C / 55°C	$\tau_{Rk,100,C2}$ [N/mm ²]	3,0	5,3	4,8	4,9	4,1	4,3
Temperature range III: 55°C / 75°C	$\tau_{Rk,100,C2}$ [N/mm ²]	1,2	2,1	1,9	1,9	1,6	1,7
Influence factor ψ on bond resistance $\tau_{Rk,C2}$ and $\tau_{Rk,100,C2}$							
Influence of concrete strength							
Temperature range I to III:	ψ_c [-]	1,0					

Injection system Hilti HIT-RE 500 V4

Performance

Essential characteristics under tension load for seismic performance category C2 in concrete

Annex C36

Table C36: Essential characteristics for metric threaded rod according Annex A under shear load for seismic category C2 in concrete

Metric threaded rod according Annex A	M12	M16	M20	M24	M27	M30
For a working life of 50 and 100 years						
Annular gap factor without Hilti Filling Set α_{gap} [-]	0,5					
Annular gap factor with Hilti Filling Set α_{gap} [-]	1,0				1)	
Steel failure without lever arm with Hilti Filling Set						
Characteristic resistance HAS 8.8, HAS-U 8.8, HIT-V-8.8, AM 8.8 $V_{RK,s,C2}$ [kN]	28	46	77	103	1)	
Steel failure without lever arm without Hilti Filling Set						
Characteristic resistance HAS 8.8, HAS-U 8.8, HIT-V-8.8, AM 8.8 $V_{RK,s,C2}$ [kN]	24	40	71	90	121	135
Characteristic resistance HAS 8.8, HAS-U 8.8 HDG, HIT-V-8.8F, AM HDG 8.8 $V_{RK,s,C2}$ [kN]	18	30	46	66	1)	
Characteristic resistance HAS A4, HAS-U A4, HIT-V-R $V_{RK,s,C2}$ [kN]	21	35	62	79	76	84
Characteristic resistance HAS-U HCR, HIT-V-HCR $V_{RK,s,C2}$ [kN]	24	40	71	79	106	118
Characteristic resistance Commercial standard threaded rod 8.8 $V_{RK,s,C2}$ [kN]	17	28	50	63	85	95
Characteristic resistance Commercial standard threaded rod A4 $V_{RK,s,C2}$ [kN]	15	25	43	55	53	59
Characteristic resistance Commercial standard threaded rod HCR $V_{RK,s,C2}$ [kN]	17	28	50	55	74	83

1) No performance assessed.

Injection system Hilti HIT-RE 500 V4

Performance

Essential characteristics under shear load for seismic performance category C2 in concrete

Annex C37

Table C37: Displacements for metric threaded rod according Annex A under tension load for seismic category C2 in concrete

Metric threaded rod according Annex A		M12	M16	M20	M24	M27	M30
Threaded rod, HAS 8.8, HAS-U-..., HIT-V-..., AM...8.8	$\delta_{N,C2(DLS)}$ [mm]	0,2	0,5	0,5	0,4	0,4	0,5
	$\delta_{N,C2(ULS)}$ [mm]	0,6	1,2	0,9	0,8	1,0	0,9

Table C38: Displacements for metric threaded rod according Annex A under shear load for seismic category C2 in concrete

Metric threaded rod according Annex A		M12	M16	M20	M24	M27	M30
Installation with Hilti Filling Set							
HAS 8.8, HAS-U 8.8, HIT-V 8.8, AM 8.8	$\delta_{V,C2(DLS)}$ [mm]	0,6	1,2	1,4	1,1	1)	
	$\delta_{V,C2(ULS)}$ [mm]	3,1	3,2	3,7	2,6	1)	
Installation without Hilti Filling Set							
Threaded rod, HAS..., HAS-U-..., HIT-V-..., AM 8.8	$\delta_{V,C2(DLS)}$ [mm]	1,9	3,2	2,5	3,5	3,0	1,9
	$\delta_{V,C2(ULS)}$ [mm]	4,4	9,2	7,1	10,2	7,2	6,3
HAS 8.8 HDG, HAS-U 8.8 HDG, HIT-V-F 8.8, AM HDG 8.8	$\delta_{V,C2(DLS)}$ [mm]	2,2	2,3	3,8	3,4	1)	
	$\delta_{V,C2(ULS)}$ [mm]	4,1	4,3	9,1	8,4	1)	

1) No performance assessed.

Injection system Hilti HIT-RE 500 V4

Performance

Displacements for seismic performance category C2 in concrete

Annex C38

Characteristic bond resistance of a single bonded fastener $\tau_{Rk,fi,p}(\theta)$ for concrete strength classes C20/25 to C50/60 with all drilling methods under fire conditions²

The characteristic bond resistance of a single bonded fastener under fire conditions $\tau_{Rk,fi,p}$ for a given temperature (θ) shall be calculated using the following equations:

$$\tau_{Rk,fi,p}(\theta) = k_{fi,p}(\theta) \cdot \tau_{Rk,cr,C20/25}$$

where: $\theta \leq \theta_{max}$: $k_{fi,p}(\theta) = k_{fi,p,100y}(\theta) = 39,83 \cdot \theta^{-1,266} \leq 1,0$

and $\theta < \theta_{max}$: $k_{fi,p}(\theta) = k_{fi,p,100y}(\theta) = 0,0$

$\theta_{max} = 305^{\circ}\text{C}$

$\tau_{Rk,fi,p}$ = characteristic bond resistance for cracked concrete under fire exposure for a given temperature (θ)

$k_{fi,p}(\theta)$ = reduction factor for bond resistance under fire exposure

$\tau_{Rk,cr,C20/25}$ = characteristic bond resistance for cracked concrete for concrete strength class C20/25 for the relevant temperature range

Figure C5: Reduction factor $k_{fi,p}(\theta)$

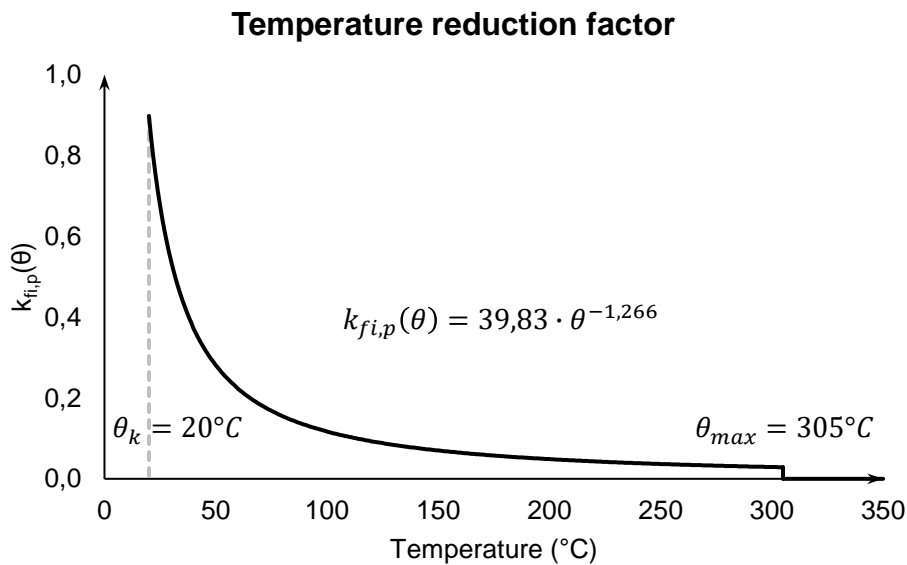

² Refer to Annex B1 for the characteristic resistance of a fastener, a group of fasteners and the tensioned fasteners of a group of fasteners in case of combined pull-out and concrete failure under fire conditions $N_{Rk,p,fi}$

Injection system Hilti HIT-RE 500 V4

Performance

Reduction factor for pull-out failure of single fasteners under fire conditions

Annex C39

Table C39: Characteristic resistance under tension load in case of steel failure under fire conditions

Fastener size		M8	M10	M12	M16	M20	M24	M27	M30
HAS 5.8, 5.8 HDG	$N_{Rk,s,fi(30)}$ [kN]	1,04	1,77	2,76	5,15	8,04	11,58	15,05	18,40
HAS 8.8, 8.8 HDG	$N_{Rk,s,fi(60)}$ [kN]	0,81	1,34	2,03	3,79	5,91	8,51	11,07	13,53
HAS-U 5.8, 5.8 HDG	$N_{Rk,s,fi(90)}$ [kN]	0,59	0,91	1,30	2,42	3,78	5,45	7,09	8,66
HIT-V 5.8, 5.8F	$N_{Rk,s,fi(120)}$ [kN]	0,47	0,70	0,94	1,74	2,72	3,92	5,09	6,22
HAS A4 HAS-U A4-70 HAS-U HCR	$N_{Rk,s,fi(30)}$ [kN]	2,67	4,85	7,94	14,78	23,06	33,23	43,21	52,81
	$N_{Rk,s,fi(60)}$ [kN]	1,93	3,44	5,57	10,37	16,18	23,32	30,32	37,06
	$N_{Rk,s,fi(90)}$ [kN]	1,18	2,03	3,20	5,96	9,30	13,40	17,43	21,30
	$N_{Rk,s,fi(120)}$ [kN]	0,80	1,33	2,02	3,76	5,86	8,44	10,98	13,42

Table C40: Characteristic resistance under tension load in case of steel failure under fire conditions

Fastener size		[in.]	3/8	1/2	5/8	3/4	7/8	1	1 1/4
HAS-E-55 HAS-B-105 (HDG)	$N_{Rk,s,fi(30)}$ [kN]		1,50	3,00	4,78	7,08	9,77	12,82	20,50
	$N_{Rk,s,fi(60)}$ [kN]		1,15	2,21	3,52	5,20	7,18	9,42	15,08
	$N_{Rk,s,fi(90)}$ [kN]		0,79	1,41	2,25	3,33	4,60	6,03	9,65
	$N_{Rk,s,fi(120)}$ [kN]		0,61	1,02	1,62	2,39	3,31	4,34	6,94

Table C41: Characteristic resistance under tension load in case of concrete cone and splitting failure under fire conditions

Fastener size			M8, M10, M12, M16, M20, M24, M27, M30 [in.] 3/8, 1/2, 5/8, 3/4, 7/8, 1, 1 1/4						
HAS 5.8, 5.8 HDG HAS 8.8, 8.8 HDG HAS-U 5.8, 5.8 HDG HAS-U 8.8, 8.8 HDG HIT-V 5.8, 5.8F HIT-V 8.8, 8.8F	$N_{Rk,c,fi(30)}^0$ [kN]		$\frac{h_{ef}}{200} \cdot N_{Rk,c}^0 \leq N_{Rk,c}^0$						
	$N_{Rk,c,fi(60)}^0$ [kN]								
	$N_{Rk,c,fi(90)}^0$ [kN]								
	$N_{Rk,c,fi(120)}^0$ [kN]								
HAS-E-55 HAS-B-105 (HDG) HAS A4 HAS-U A4-70 HAS-U HCR	$N_{Rk,c,fi(120)}^0$ [kN]		$0,8 \cdot \frac{h_{ef}}{200} \cdot N_{Rk,c}^0 \leq N_{Rk,c}^0$						
Characteristic spacing	$S_{cr,N,fi}$ [mm]		$4h_{ef}$						
Characteristic edge distance	$C_{cr,N,fi}$ [mm]		$2h_{ef}$						

Injection system Hilti HIT-RE 500 V4

Performance

Characteristic resistance under tension load in case of steel and concrete cone failure under fire conditions

Annex C40

Table C42: Characteristic resistance under shear load in case of steel failure under fire conditions

Fastener size		M8	M10	M12	M16	M20	M24	M27	M30
HAS 5.8, 5.8 HDG HAS 8.8, 8.8 HDG HAS-U 5.8, 5.8 HDG HAS-U 8.8, 8.8 HDG HIT-V 5.8, 5.8F HIT-V 8.8, 8.8F	$V_{Rk,s,fi(30)}$ [kN]	1,04	1,77	2,76	5,15	8,04	11,58	15,05	18,40
	$V_{Rk,s,fi(60)}$ [kN]	0,81	1,34	2,03	3,79	5,91	8,51	11,07	13,53
	$V_{Rk,s,fi(90)}$ [kN]	0,59	0,91	1,30	2,42	3,78	5,45	7,09	8,66
	$V_{Rk,s,fi(120)}$ [kN]	0,47	0,70	0,94	1,74	2,72	3,92	5,09	6,22
	$M_{Rk,s,fi(30)}^0$ [Nm]	1,06	2,28	4,29	10,92	21,28	36,81	54,58	73,76
	$M_{Rk,s,fi(60)}^0$ [Nm]	0,83	1,73	3,15	8,02	15,65	27,07	40,14	54,23
	$M_{Rk,s,fi(90)}^0$ [Nm]	0,60	1,17	2,02	5,13	10,01	17,32	25,69	34,71
	$M_{Rk,s,fi(120)}^0$ [Nm]	0,48	0,89	1,45	3,69	7,20	12,45	18,46	24,95
HAS A4 HAS-U A4-70 HAS-U HCR	$V_{Rk,s,fi(30)}$ [kN]	2,67	4,85	7,94	14,78	23,06	33,23	43,21	52,81
	$V_{Rk,s,fi(60)}$ [kN]	1,93	3,44	5,57	10,37	16,18	23,32	30,32	37,06
	$V_{Rk,s,fi(90)}$ [kN]	1,18	2,03	3,20	5,96	9,30	13,40	17,43	21,30
	$V_{Rk,s,fi(120)}$ [kN]	0,80	1,33	2,02	3,76	5,86	8,44	10,98	13,42
	$M_{Rk,s,fi(30)}^0$ [Nm]	2,73	6,25	12,33	31,34	61,10	105,67	156,68	211,71
	$M_{Rk,s,fi(60)}^0$ [Nm]	1,97	4,43	8,65	21,99	42,87	74,14	109,93	148,55
	$M_{Rk,s,fi(90)}^0$ [Nm]	1,20	2,62	4,97	12,64	24,64	42,61	63,19	85,38
	$M_{Rk,s,fi(120)}^0$ [Nm]	0,82	1,71	3,13	7,96	15,52	26,85	39,81	53,80

Table C43: Characteristic resistance under shear load in case of steel failure under fire conditions

Fastener size		[in.]	3/8	1/2	5/8	3/4	7/8	1	1 1/4
HAS-E-55 HAS-B-105 (HDG)	$V_{Rk,s,fi(30)}$ [kN]		1,50	3,00	4,78	7,08	9,77	12,82	20,50
	$V_{Rk,s,fi(60)}$ [kN]		1,15	2,21	3,52	5,20	7,18	9,42	15,08
	$V_{Rk,s,fi(90)}$ [kN]		0,79	1,41	2,25	3,33	4,60	6,03	9,65
	$V_{Rk,s,fi(120)}$ [kN]		0,61	1,02	1,62	2,39	3,31	4,34	6,94
	$M_{Rk,s,fi(30)}^0$ [Nm]		1,96	4,45	9,77	17,59	28,54	42,88	86,77
	$M_{Rk,s,fi(60)}^0$ [Nm]		1,44	3,39	7,18	12,94	20,98	31,53	63,81
	$M_{Rk,s,fi(90)}^0$ [Nm]		0,92	2,34	4,59	8,28	13,43	20,18	40,84
	$M_{Rk,s,fi(120)}^0$ [Nm]		0,66	1,81	3,30	5,95	9,65	14,50	29,35

Injection system Hilti HIT-RE 500 V4

Performance

Characteristic resistance under shear load in case of steel failure under fire conditions

Annex C41

Table C44: Characteristic resistance under shear load in case of pryout failure under fire conditions

Fastener size		M8, M10, M12, M16, M20, M24, M27, M30 [in.] 3/8, 1/2, 5/8, 3/4, 7/8, 1, 1 1/4
HAS 5.8, 5.8 HDG HAS 8.8, 8.8 HDG	$V_{Rk,cp,fi(30)}$ [kN]	$k_8 \cdot N_{Rk,c,fi(90)}$
HAS-U 5.8, 5.8 HDG HAS-U 8.8, 8.8 HDG	$V_{Rk,cp,fi(60)}$ [kN]	
HIT-V 5.8, 5.8F HIT-V 8.8, 8.8F	$V_{Rk,cp,fi(90)}$ [kN]	
HAS-E-55 HAS-B-105 (HDG)	$V_{Rk,cp,fi(90)}$ [kN]	
HAS A4 HAS-U A4-70 HAS-U HCR	$V_{Rk,cp,fi(120)}$ [kN]	$k_8 \cdot N_{Rk,c,fi(120)}$

Table C45: Characteristic resistance under shear load in case of concrete edge failure under fire conditions

Fastener size		M8, M10, M12, M16, M20, M24, M27, M30 [in.] 3/8, 1/2, 5/8, 3/4, 7/8, 1, 1 1/4
HAS 5.8, 5.8 HDG HAS 8.8, 8.8 HDG	$V_{Rk,c,fi(30)}$ [kN]	$0,25 \cdot V_{Rk,c}^0$
HAS-U 5.8, 5.8 HDG HAS-U 8.8, 8.8 HDG	$V_{Rk,c,fi(60)}$ [kN]	
HIT-V 5.8, 5.8F HIT-V 8.8, 8.8F	$V_{Rk,c,fi(90)}$ [kN]	
HAS-E-55 HAS-B-105 (HDG)	$V_{Rk,c,fi(90)}$ [kN]	
HAS A4 HAS-U A4-70 HAS-U HCR	$V_{Rk,c,fi(120)}$ [kN]	$0,20 \cdot V_{Rk,c}^0$

Injection system Hilti HIT-RE 500 V4

Performance

Characteristic resistance under shear load in case of concrete pryout and concrete edge failure under fire conditions

Annex C42

CSTB

Centre Scientifique et
Technique du Bâtiment

84 avenue Jean Jaurès
CHAMPS-SUR-MARNE
F-77447 Marne-la-Vallée Cedex 2
Tel.: (33) 01 64 68 82 82
Fax: (33) 01 60 05 70 37

Mitglied der
EOTA
www.eota.eu

Europäische Technische Bewertung

ETA-20/0541
vom 09.06.2023

Deutsche Übersetzung erstellt von der Hilti Deutschland AG - Originalfassung in französischer Sprache

Allgemeiner Teil

Technische Bewertungsstelle, die die Europäische Technische Bewertung ausstellt:

Centre Scientifique et Technique du Bâtiment (CSTB)

Handelsname:

Injektionssystem Hilti HIT-RE 500 V4

Produktfamilie:

Verbundanker mit Gewindestangen, Bewehrungsstäben, Innengewindehülse HIS-(R)N und Hilti Zuganker HZA(-R) zur Verwendung in Beton für eine Lebensdauer von 50 und 100 Jahren

Hersteller:

Hilti Aktiengesellschaft
Feldkircher Strasse 100
FL-9494 Schaan
Fürstentum Liechtenstein

Produktionsanlagen:

Hilti Werke

Diese Europäische Technische Bewertung enthält:

68 Seiten, davon 64 Seiten Anhänge, die Bestandteil dieser Bewertung sind

Diese Europäische Technische Bewertung wird ausgestellt in Übereinstimmung mit der Verordnung (EU) Nr. 305/2011 auf der Grundlage von:

EAD 330499-02-0601 Version September 2022

Diese Bewertung ersetzt:

ETA-20/0541 datiert vom 04.09.2021

Berichtigung

Die Europäische Technische Bewertung wird von der Technischen Bewertungsstelle in ihrer Amtssprache ausgestellt. Übersetzungen dieser Europäischen Technischen Bewertung in andere Sprachen müssen dem Originaldokument vollständig entsprechen und müssen als solche gekennzeichnet sein. Diese Europäische Technische Bewertung darf, auch bei elektronischer Übermittlung, nur vollständig wiedergegeben werden. Eine teilweise Wiedergabe ist jedoch nur mit schriftlicher Zustimmung der ausstellenden Technischen Bewertungsstelle möglich. Jede teilweise Wiedergabe ist als solche zu kennzeichnen. Diese Europäische Technische Bewertung kann von der ausstellenden Technischen Bewertungsstelle zurückgezogen werden, insbesondere aufgrund einer Unterrichtung durch die Kommission gemäß Artikel 25 (3) der Verordnung (EU) Nr. 305/2011.

Besonderer Teil

1 Technische Beschreibung des Produkts

Das Injektionssystem Hilti HIT-RE 500 V4 ist ein Verbundanker, der aus einer Folienpackung mit Injektionsmörtel Hilti HIT-RE 500 V4 und einem Stahlelement besteht.

Diese Stahlelemente sind:

- eine Gewindestange Hilti HAS, HAS-U, Hilti HIT-V, Hilti Meterstange AM 8.8 oder eine handelsübliche Gewindestange mit Unterlegscheibe und Sechskantmutter im Bereich von M8 bis M30 und 3/8" bis 1 1/4".
- ein Bewehrungsstab (Rebar) im Bereich von $\phi 8$ bis $\phi 32$.
- ein Hilti Zuganker HZA im Bereich von M12 bis M27 oder HZA-R im Bereich von M12 bis M24.
- eine Innengewindehülse HIS-(R)N im Bereich von M8 bis M20 und 3/8" bis 3/4".

Das Stahlelement wird in ein mit Injektionsmörtel gefülltes Bohrloch gesetzt und über den Verbund zwischen Stahlelement, Injektionsmörtel und Beton verankert.

Die Abbildung und Beschreibung des Produkts enthalten die Anhänge A.

2 Verwendungszweck

Die in Abschnitt 3 angegebenen Leistungen sind nur gültig, wenn das Verbindungselement entsprechend den Angaben und unter den Bedingungen nach den Anhängen B verwendet wird.

Die Prüf- und Bewertungsmethoden, die dieser Europäischen Technischen Bewertung zu Grunde liegen, führen zur Annahme einer Nutzungsdauer des Verbindungselements von 50 und 100 Jahren. Die Angabe einer Nutzungsdauer kann nicht als Garantie des Herstellers verstanden werden, sondern ist lediglich ein Hilfsmittel zur Auswahl des richtigen Produkts in Bezug auf die angenommene wirtschaftlich angemessene Nutzungsdauer des Bauwerks.

3 Leistung des Produktes

3.1 Mechanische Festigkeit und Standsicherheit (BWR 1)

Wesentliche Eigenschaften	Leistung
Charakteristischer Widerstand für statische und quasistatische Lasten, Verschiebungen	Siehe Anhänge C1 bis C28
Charakteristischer Widerstand für die seismische Leistungskategorie C1	Siehe Anhänge C29 bis C35
Charakteristischer Widerstand für die seismische Leistungskategorie C2, Verschiebungen	Siehe Anhänge C36 bis C38

3.2 Brandschutz (BWR 2)

Wesentliche Eigenschaften	Leistung
Brandverhalten	Die Verbindungselemente erfüllen die Anforderungen der Klasse A1
Feuerwiderstand	Siehe Anhänge C39 bis C42

3.3 Hygiene, Gesundheit und Umweltschutz (BWR 3)

Bezüglich gefährlicher Stoffe können die Produkte im Geltungsbereich dieser Europäischen Technischen Bewertung weiteren Anforderungen unterliegen (z. B. umgesetzte europäische Gesetzgebung und nationale Gesetze, Rechts- und Verwaltungsvorschriften). Um die

Bestimmungen der Bauproduktenrichtlinie zu erfüllen, müssen diese Anforderungen eingehalten werden, wenn und insoweit sie gelten.

3.4 Nutzungssicherheit (BWR 4)

Für die Grundanforderung Nutzungssicherheit gelten die gleichen Anforderungen wie für die Grundanforderung Mechanische Festigkeit und Stabilität.

3.5 Schallschutz (BWR 5)

Nicht relevant.

3.6 Energieeinsparung und Wärmeschutz (BWR 6)

Nicht relevant.

3.7 Nachhaltige Nutzung der natürlichen Ressourcen (BWR 7)

Für die nachhaltige Nutzung der natürlichen Ressourcen wurde für dieses Produkt keine Leistung festgestellt.

3.8 Allgemeine Aspekte zur Gebrauchstauglichkeit

Dauerhaftigkeit und Gebrauchstauglichkeit sind nur dann sichergestellt, wenn die Angaben zum Verwendungszweck gemäß Anhang B1 eingehalten werden.

4 Bewertung und Überprüfung der Leistungsbeständigkeit (AVCP)

Gemäß der Entscheidung 96/582/EG der Europäischen Kommission¹, in der geänderten Fassung, gilt das System zur Bewertung und Überprüfung der Leistungsbeständigkeit (siehe Anhang V der Verordnung (EU) Nr. 305/2011) entsprechend der folgenden Tabelle.

Produkt	Verwendungszweck	Stufe oder Klasse	System
Verbundanker für die Verwendung in Beton	Zur Verankerung und/oder Unterstützung tragender Bauteile in Beton (die zur Stabilität des Bauwerks beitragen) oder schwerer Bauelemente	-	1

5 Für die Umsetzung des AVCP-Systems Notwendige technische Details, wie in der entsprechenden EAD vorgesehen

Technische Einzelheiten, die für die Durchführung des Systems zur Bewertung und Überprüfung der Leistungsbeständigkeit (AVCP) notwendig sind, sind Bestandteil des Prüfplans, der beim Centre Scientifique et Technique du Bâtiment hinterlegt ist.

In dieser Europäischen Technischen Bewertung wird auf die folgenden Standards verwiesen:

- EN 1992-1-1:2004 + AC:2010 Eurocode 2: Bemessung von Betontragwerken - Teil 1-1: Allgemeine Regeln und Regeln für Gebäude
- EN 1992-1-2:2004 + AC:2008 Eurocode 2: Bemessung von Betontragwerken – Teil 1-2: Allgemeine Regeln – Tragwerksbemessung im Brandfall
- EN 1992-4:2018 Eurocode 2: Bemessung von Betontragwerken – Teil 4: Bemessung von Befestigungsmitteln für die Verwendung in Beton
- EN 1993-1-4:2006 + A1:2015 Eurocode 3: Bemessung von Stahlbauten, Teil 1-4: Allgemeine Regeln – Ergänzende Regeln für nichtrostende Stähle
- EN 1998-1:2004 + A1:2013 Eurocode 8: Bemessung von Bauwerken für den Erdbebenschutz – Teil 1: Allgemeine Regeln, seismische Einwirkungen und Regeln für Gebäude
- EN 10088-1:2014 Nichtrostende Stähle – Teil 1: Liste der Edelstahlsorten
- EN 206:2013 + A2:2021 Beton: Spezifikation, Leistung, Herstellung und Konformität

¹ Amtsblatt der Europäischen Gemeinschaften L 254 vom 08.10.1996

Der Kontrollplan mit vertraulichen Informationen ist nicht im veröffentlichten Teil dieser ETA enthalten.

Der Hersteller muss eine Notifizierte Stelle einschalten auf der Basis eines Vertrages, die zugelassen ist für die Ausstellung des Konformitätszertifikates CE für Verbindungselemente auf der Grundlage des Prüfplans.

Die benannte Stelle besucht das Werk mindestens zweimal im Jahr zur Überwachung des Herstellers.

Die französische Originalfassung ist unterschrieben von:

Anca Cronopol

Head of the Structure, Masonry, Partition Division (Leiterin der Abteilung Struktur, Mauerwerk, Trennwände)

Einbauzustand

Abbildung A1: Gewindestange, HAS ..., HAS-U..., HAS-..., HIT-V-..., AM...



Abbildung A2: Gewindestange, HAS ..., HAS-U-..., HIT-V-..., AM..., mit Hilti Verfüll-Set...



Abbildung A3: Innengewindehülse HIS-(R)N

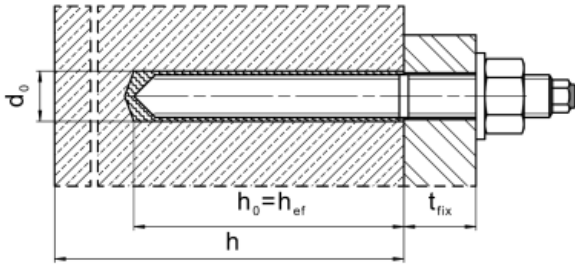

Abbildung A4: Bewehrungsstab (Rebar)

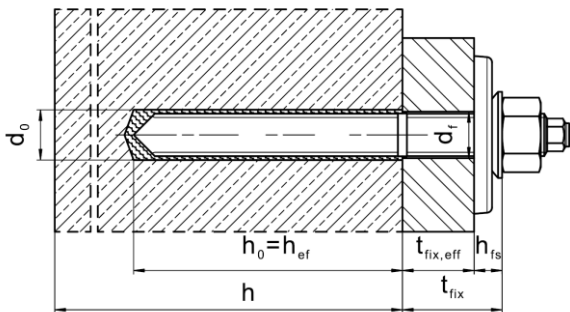

Injektionssystem Hilti HIT-RE 500 V4

Produktbeschreibung
Einbauzustand

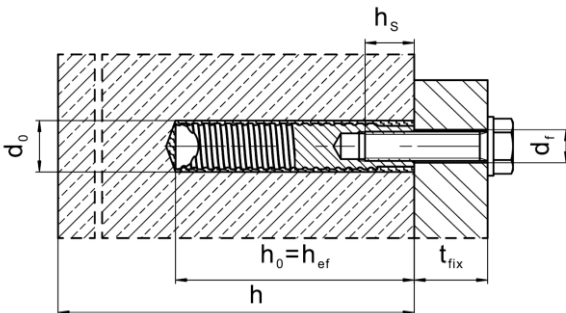
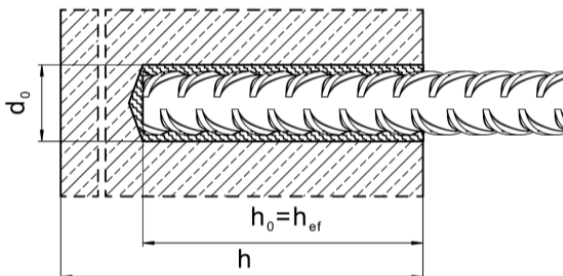
Anhang A1

Produktbeschreibung: Injektionsmörtel und Stahlelemente

Injektionsmörtel Hilti HIT-RE 500 V4: Epoxidharzsystem mit Zuschlagstoff

330 ml, 500 ml und 1400 ml

Kennzeichnung:
 HILTI HIT
 Produktname
 Produktionszeit und -linie
 Haltbarkeitsdatum MM/JJJJ



Produktname: „Hilti HIT-RE 500 V4“

Statikmischer Hilti HIT-RE-M



Stahlelemente



Kennzeichnung

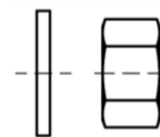

Unterlegscheibe Mutter

HAS-U...: M8 bis M30

Kennzeichnung: Stahlsortennummer und Längenkennziffer

- 5 = HAS-U 5.8, 5.8 HDG
- 8 = HAS-U 8.8, 8.8. HDG
- 1 = HAS-U A4
- 2 = HAS-U HCR

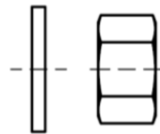

Unterlegscheibe Mutter

HAS ...: M8 bis M30

HAS Farbcode-Kennzeichnung:

- 5.8 = RAL 5010 (blau)
- 8.8 = RAL 1023 (gelb)
- A4 = RAL 3000 (rot)

AM ... 8.8: (HDG) M8 bis M30

Injektionssystem Hilti HIT-RE 500 V4

Produktbeschreibung
 Stahlelemente

Anhang A2

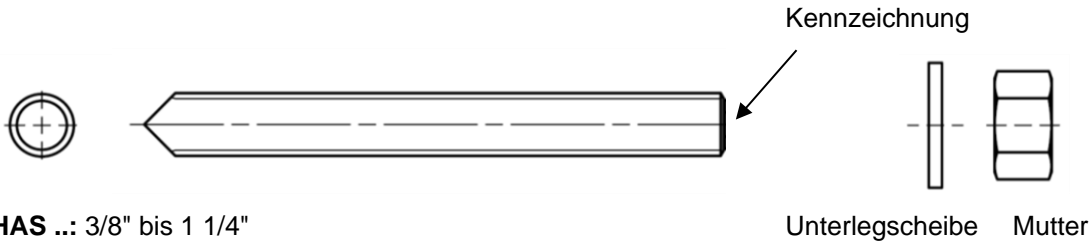

HAS ..: 3/8" bis 1 1/4"

Kennzeichnung: Stahlsorte und Elementlänge [in.]

- V = HAS-V-36 (HDG)
- E = HAS-E-55
- B = HAS-B-105 (HDG)
- R1 = HAS-R 304
- R2 = HAS-R 316

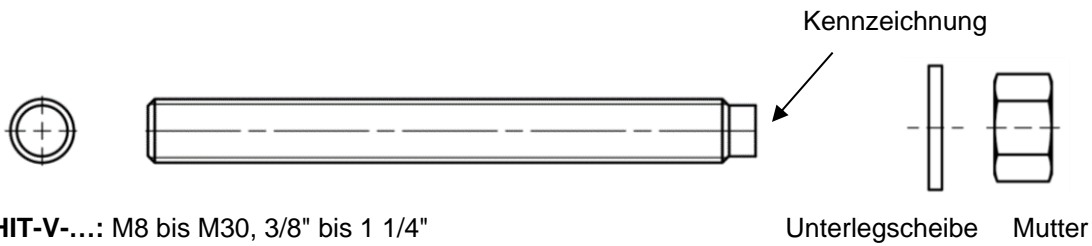

HIT-V-...: M8 bis M30, 3/8" bis 1 1/4"

Kennzeichnung: z. B.

- 5.8 - l = HIT-V-5.8 M...x l
- 5.8F - l = HIT-V-5.8F M...x l
- 8.8 - l = HIT-V-8.8 M...x l
- 8.8F - l = HIT-V-8.8F M...x l
- R - l = HIT-V-R M...x l
- HCR - l = HIT-V-HCR M...x l

Handelsübliche Standard-Gewindestange: M8 bis M30, 3/8" bis 1 1/4"

- Werkstoffe und mechanische Eigenschaften gemäß Tabelle A2.
- Abnahmeprüfzeugnis 3.1 nach EN 10204. Das Dokument muss aufbewahrt werden.
- Kennzeichnung der Einbindetiefe.

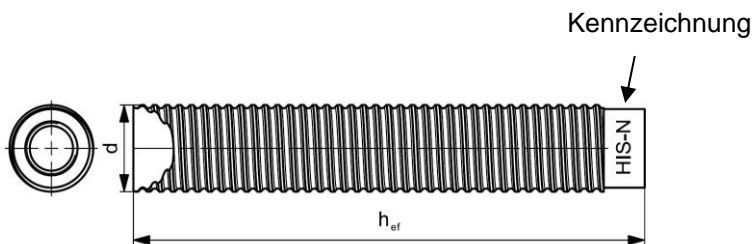

Innengewindehülse HIS-(R)N: M8 bis M20, 3/8" bis 3/4".

Kennzeichnung:

Kennzeichnung - HILTI und Prägung „HIS-N“ (für verzinkten Stahl) oder Prägung „HIS-RN“ (für rostfreien Stahl)

Injektionssystem Hilti HIT-RE 500 V4

Produktbeschreibung
 Stahlelemente

Anhang A3

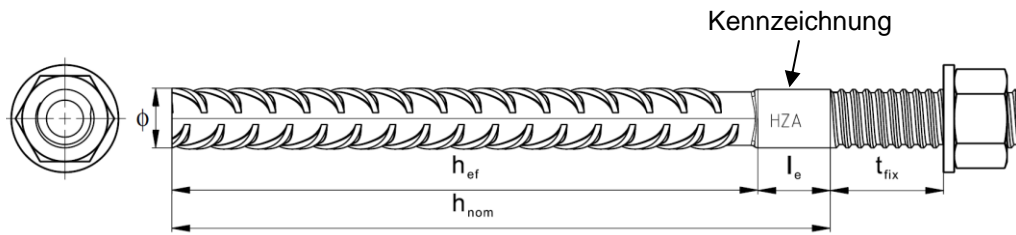

Hilti Zuganker HZA: M12 bis M27
Hilti Zuganker HZA-R: M12 bis M24

Kennzeichnung:
 Prägung „HZA-R“ M .. / t_{fix}

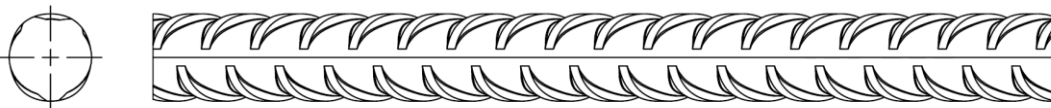

Bewehrungsstab (Rebar): $\phi 8$ bis $\phi 32$

- Werkstoffe und mechanische Eigenschaften gemäß Tabelle A2.
- Abmessungen gemäß Anhang B
- Mindestwert der zugehörigen Rippenfläche $f_{R,min}$ gemäß EN 1992-1-1:2004+AC:2010
- Die Rippenhöhe des Stabes h_{rib} muss im Bereich $0,05 \cdot \phi \leq h_{rib} \leq 0,07 \cdot \phi$ liegen (ϕ : Nenndurchmesser des Stabes; h_{rib} : Rippenhöhe des Stabes)

Hilti Verfüllset zum Füllen des Ringspalts zwischen Stahlelement und Anbauteil

Dichtungsscheibe

Kugelförmige Unterlegscheibe



Tabelle A1: Geometrie des Hilti Füllsets

Hilti Füllset	M8	M10	M12	M16	M20	M24
Durchmesser der Dichtungsscheibe d_{vs} [mm]	38	42	44	52	60	70
Dicke der Dichtungsscheibe h_{vs} [mm]	5			6		
Dicke des Hilti Füllsets h_{fs} [mm]	8	9	10	11	13	15

Injektionssystem Hilti HIT-RE 500 V4

Produktbeschreibung
 Stahlelemente

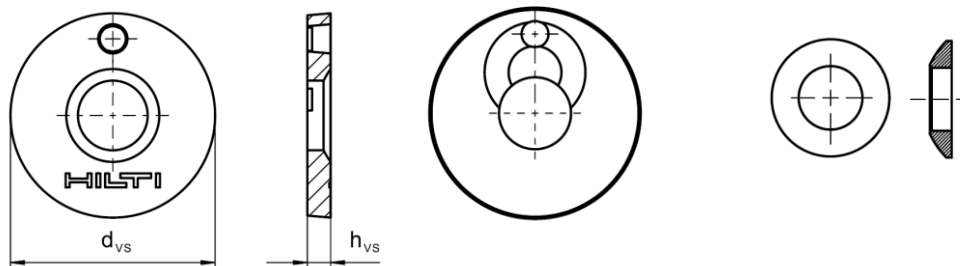
Anhang A4

Tabelle A2: Werkstoffe

Bezeichnung	Material
Betonstahl (Rebars)	
Betonstahl EN 1992-1-1:2004 und AC:2010, Anhang C	Stäbe und Betonstabstahl vom Ring Klasse B oder C mit f_{yk} und k gemäß NDP oder NCL der EN 1992-1-1/NA:2013 $f_{uk} = f_{tk} = k \cdot f_{yk}$
Stahlelemente aus verzinktem Stahl	
HAS 5.8 (HDG), HAS-U 5.8 (HDG), HIT-V-5.8 (F), Gewindestange 5.8	Festigkeitsklasse 5.8, $f_{uk} = 500 \text{ N/mm}^2$, $f_{yk} = 400 \text{ N/mm}^2$ Bruchdehnung ($l_0 = 5d$) > 8% dehnbar Galvanisch verzinkt $\geq 5 \mu\text{m}$, (F) oder (HDG) feuerverzinkt $\geq 50 \mu\text{m}$
Gewindestange 6.8	Festigkeitsklasse 6.8, $f_{uk} = 600 \text{ N/mm}^2$, $f_{yk} = 480 \text{ N/mm}^2$ Bruchdehnung ($l_0 = 5d$) > 8% dehnbar Galvanisch verzinkt $\geq 5 \mu\text{m}$, (F) oder (HDG) feuerverzinkt $\geq 50 \mu\text{m}$
HAS 8.8 (HDG), HAS-U-8.8 (HDG), HIT-V-8.8 (F), AM 8.8 Gewindestange 8.8	Festigkeitsklasse 8.8, $f_{uk} = 800 \text{ N/mm}^2$, $f_{yk} = 640 \text{ N/mm}^2$ Bruchdehnung ($l_0 = 5d$) > 12% dehnbar Galvanisch verzinkt $\geq 5 \mu\text{m}$, (F) oder (HDG) feuerverzinkt $\geq 50 \mu\text{m}$
Hilti Zuganker HZA	Rundstahl mit Gewindeteil: galvanisch verzinkt ³ 5 mm Bewehrungsstäbe: Stäbe Klasse B nach NDP oder NCL der EN 1992-1-1/NA
Hülse mit Innengewinde HIS-N	Galvanisch verzinkt $\geq 5 \mu\text{m}$
Gewindestange, HIT-V	ASTM A 307 Klasse A, $f_{uk} = 414 \text{ N/mm}^2$, $f_{yk} = 259 \text{ N/mm}^2$ Bruchdehnung ($l_0 = 5d$) > 8% dehnbar Galvanisch verzinkt $\geq 5 \mu\text{m}$
Gewindestange, HAS-V-36 (HDG)	ASTM F1554, Grade 36, $f_{uk} = 400 \text{ N/mm}^2$, $f_{yk} = 248 \text{ N/mm}^2$ Bruchdehnung ($l_0 = 5d$) > 23% dehnbar Galvanisch verzinkt $\geq 5 \mu\text{m}$, (HDG) feuerverzinkt $\geq 53 \mu\text{m}$
Gewindestange, HAS-E-55	ASTM F1554, Grade 55, $f_{uk} = 517 \text{ N/mm}^2$, $f_{yk} = 379 \text{ N/mm}^2$ Bruchdehnung ($l_0 = 5d$) > 21% dehnbar Galvanisch verzinkt $\geq 5 \mu\text{m}$
Gewindestange, HAS-B-105 (HDG)	ASTM F1554, Grade 105, $f_{uk} = 862 \text{ N/mm}^2$, $f_{yk} = 724 \text{ N/mm}^2$ Bruchdehnung ($l_0 = 5d$) > 15% dehnbar Galvanisch verzinkt $\geq 5 \mu\text{m}$, (HDG) feuerverzinkt $\geq 53 \mu\text{m}$
Unterlegscheibe	Galvanisch verzinkt $\geq 5 \mu\text{m}$, feuerverzinkt $\geq 50 \mu\text{m}$
Mutter	Nennfestigkeitsklasse gleich oder höher als die Nennfestigkeitsklasse des Stabs Galvanisch verzinkt $\geq 5 \mu\text{m}$, feuerverzinkt $\geq 50 \mu\text{m}$
Hilti Verfüll-Set (F)	Füllscheibe: Galvanisch verzinkt $\geq 5 \mu\text{m}$, (F) feuerverzinkt $\geq 50 \mu\text{m}$ Kugelscheibe: Galvanisch verzinkt $\geq 5 \mu\text{m}$, (F) feuerverzinkt $\geq 50 \mu\text{m}$ Kontermutter: Galvanisch verzinkt $\geq 5 \mu\text{m}$, (F) Galvanisch Zink-Nickel beschichtet $6 \mu\text{m}$

Injektionssystem Hilti HIT-RE 500 V4

Produktbeschreibung
Werkstoffe

Anhang A5

Tabelle A2: Fortsetzung

Stahlelemente aus Edelstahl	
Korrosionsbeständigkeitsklasse (CRC II) nach EN 1993-1-4	
Gewindestange	Für ≤ M24: Festigkeitsklasse 70, $f_{uk} = 700 \text{ N/mm}^2$, $f_{yk} = 450 \text{ N/mm}^2$ Für > M24: Festigkeitsklasse 50, $f_{uk} = 500 \text{ N/mm}^2$, $f_{yk} = 210 \text{ N/mm}^2$ Bruchdehnung ($l_0 = 5d$) > 12% dehnbar Edelstahl 1.4301, 1.4307, 1.4311, 1.4541, 1.4306, 1.4567 EN 10088-1
Unterlegscheibe	Edelstahl 1.4301, 1.4307, 1.4311, 1.4541, 1.4306, 1.4567 EN 10088-1
Mutter	Für ≤ M24: Festigkeitsklasse 70, $f_{uk} = 700 \text{ N/mm}^2$, $f_{yk} = 450 \text{ N/mm}^2$ Für > M24: Festigkeitsklasse 50, $f_{uk} = 500 \text{ N/mm}^2$, $f_{yk} = 210 \text{ N/mm}^2$ Edelstahl 1.4301, 1.4307, 1.4311, 1.4541, 1.4306, 1.4567 nach EN 10088-1: 2014
Gewindestange, HAS-R 304	Größe 3/8" bis 5/8": ASTM F593 CW1, $f_{uk} = 689 \text{ N/mm}^2$, $f_{yk} = 448 \text{ N/mm}^2$ Bruchdehnung ($l_0 = 5d$) > 12% dehnbar Größe 3/4" bis 1": ASTM F593 CW2, $f_{uk} = 586 \text{ N/mm}^2$, $f_{yk} = 310 \text{ N/mm}^2$ Bruchdehnung ($l_0 = 5d$) > 12% dehnbar Größe > 1": ASTM A193 Grade 8(M), Class 1, $f_{uk} = 515 \text{ N/mm}^2$, $f_{yk} = 205 \text{ N/mm}^2$ Bruchdehnung ($l_0 = 5d$) > 12% dehnbar
Unterlegscheibe	Edelstahl ASTM F593 und ASTM A193
Mutter	Nennfestigkeitsklasse gleich oder höher als die Nennfestigkeitsklasse des Stabs
Stahlelemente aus Edelstahl	
Korrosionsbeständigkeitsklasse (CRC III) nach EN 1993-1-4	
HAS A4, HAS-U A4, HIT-V-R, Gewindestange A4	Für ≤ M24: Festigkeitsklasse 70, $f_{uk} = 700 \text{ N/mm}^2$, $f_{yk} = 450 \text{ N/mm}^2$ Für > M24: Festigkeitsklasse 50, $f_{uk} = 500 \text{ N/mm}^2$, $f_{yk} = 210 \text{ N/mm}^2$ Bruchdehnung ($l_0 = 5d$) > 12% dehnbar Edelstahl 1.4401, 1.4404, 1.4578, 1.4571, 1.4439, 1.4362 nach EN 10088-1
Hilti Zuganker HZA-R	Rundstahl mit Gewindeteil: Edelstahl gemäß EN 10088-1:2014 Bewehrungsstäbe: Stäbe Klasse B nach NDP oder NCL der EN 1992-1-1/NA:2013
Innengewindehülse HIS-RN	Edelstahl 1.4401, 1.4571 EN 10088-1
Gewindestange, HAS-R 316	Größe 3/8" bis 5/8": ASTM F593 CW1, $f_{uk} = 689 \text{ N/mm}^2$, $f_{yk} = 448 \text{ N/mm}^2$ Bruchdehnung ($l_0 = 5d$) > 12% dehnbar Größe 3/4" bis 1 1/4": ASTM F 593 CW2, $f_{uk} = 586 \text{ N/mm}^2$, $f_{yk} = 310 \text{ N/mm}^2$ Bruchdehnung ($l_0 = 5d$) > 12% dehnbar
Unterlegscheibe	Edelstahl ASTM F593
Mutter	Nennfestigkeitsklasse gleich oder höher als die Nennfestigkeitsklasse des Stabs
Hilti Verfüll-Set A4	Füllscheibe: Edelstahl gemäß EN 10088-1 Kugelscheibe: Edelstahl gemäß EN 10088-1 Kontermutter: Edelstahl gemäß EN 10088-1

Injektionssystem Hilti HIT-RE 500 V4

Produktbeschreibung
 Werkstoffe

Anhang A6

Tabelle A2: Fortsetzung

Stahlelemente aus hochkorrosionsbeständigem Stahl Korrosionsbeständigkeitsklasse (CRC V) nach EN 1993-1-4	
HAS-U HCR, HIT-V-HCR, Gewindestange	Für $\leq M20$: $f_{uk} = 800 \text{ N/mm}^2$, $f_{yk} = 640 \text{ N/mm}^2$ Für $> M20$: $f_{uk} = 700 \text{ N/mm}^2$, $f_{yk} = 400 \text{ N/mm}^2$ Bruchdehnung ($l_0 = 5d$) $> 12\%$ dehnbar Hochkorrosionsbeständiger Stahl 1.4529, 1.4565 EN 10088-1
Unterlegscheibe	Hochkorrosionsbeständiger Stahl 1.4529, 1.4565 EN 10088-1
Mutter	Nennfestigkeitsklasse gleich oder höher als die Nennfestigkeitsklasse des Stabs Hochkorrosionsbeständiger Stahl 1.4529, 1.4565 EN 10088-1

Injektionssystem Hilti HIT-RE 500 V4

Verwendungszweck
 Spezifikationen

Anhang B2

Spezifizierung des Verwendungszwecks

Beanspruchung der Verankerungen:

- Statische und quasistatische Belastung.
- Seismische Leistungskategorie C1.
- Seismische Leistungskategorie C2 (HAS (8.8, 8.8 HDG, A4), HAS-U (8.8, 8.8 HDG, A4, HCR), HIT-V (-8.8, -8.8F, -R, -HCR), AM (8.8, 8.8 HDG) und Standard-Gewindestange (8.8, A4, HCR)), mit Hammerbohrung und Hammerbohrung mit Hilti Hohlbohrer TE-CD, TE-YD.
- Brandeinwirkung: Gewindestange Größe M8 bis M30 (HAS (5.8, 5.8 HDG, 8.8, 8.8 HDG, A4-70), (HAS-U (5.8, 5.8 HDG, 8.8, 8.8 HDG, A4-70, HCR), HIT-V (5.8, 5.8F, 8.8, 8.8F ,R, HCR), 3/8 bis 1 1/4 (HAS-E-55, HAS-B-105 (HDG))).

Verankerungsgrund:

- Verdichteter bewehrter oder unbewehrter verdichteter Normalbeton ohne Fasern nach EN 206.
- Festigkeitsklassen C20/25 bis C50/60 nach EN 206.
- Gerissener und ungerissener Beton.

Temperatur im Verankerungsgrund:

- **beim Einbau**
-5 °C bis +40 °C für die Standard-Temperaturschwankungen nach dem Einbau
- **im Gebrauchszustand**
Temperaturbereich I: -40 °C bis +40 °C
(max. Langzeittemperatur +24 °C und max. Kurzzeittemperatur +40 °C)
Temperaturbereich II: -40 °C bis +55 °C
(max. Langzeittemperatur +43 °C und max. Kurzzeittemperatur +55 °C)
Temperaturbereich III: -40 °C bis +75 °C
(max. Langzeittemperatur +55 °C und max. Kurzzeittemperatur +75 °C)

Einsatzbedingungen (Umweltbedingungen):

- Konstruktionen, die trockenen inneren Bedingungen ausgesetzt sind (alle Materialien).
- Für alle anderen Bedingungen gemäß EN 1993-1-4 entsprechend den Korrosionsbeständigkeitsklassen Anhang A (rostfreier Stahl und hochkorrosionsbeständiger Stahl).

Bemessung:

- Die Konstruktion von Verankerungen erfolgt unter der Verantwortung eines auf dem Gebiet der Verankerungen und des Betonbaus erfahrenen Ingenieurs.
- Unter Berücksichtigung der zu verankernden Lasten sind prüfbare Berechnungen und Konstruktionszeichnungen anzufertigen. Die Position des Befestigungselements wird auf den Konstruktionszeichnungen angegeben (z. B. die Position des Befestigungselements im Verhältnis zur Bewehrung oder zu den Stützen usw.).
- Die Befestigungselemente werden in Übereinstimmung mit EN 1992-4 und dem EOTA Technical Report TR 055 bemessen. Befestigungselemente, die unter seismischen Einwirkungen stehen, sind außerhalb von kritischen Bereichen (z. B. plastischen Gelenken) der Betonstruktur zu positionieren. Befestigungen in Abstandsmontage oder mit einer Mörtelschicht unter seismischer Einwirkung werden in dieser Europäischen Technischen Bewertung (ETA) nicht behandelt.
- Für Anwendungen mit Feuerwiderstand werden die Befestigungen in Übereinstimmung mit dem EOTA TR 082 „Bemessung von Verbundanker in Beton unter Brandbedingungen“ ausgelegt.

Injektionssystem Hilti HIT-RE 500 V4

Verwendungszweck
Spezifikationen

Anhang B2

Einbau:

- Nutzungskategorie:
 - trockener oder nasser Beton (nicht in wassergefüllten Bohrlöchern): für alle Bohrtechniken.
 - Wassergefüllte Bohrlöcher: nur für Hammerbohrungen, nur für ungerissenen Beton.
- Bohrverfahren:
 - Hammerbohren,
 - Hammerbohren mit Hilti Hohlbohrer TE-CD, TE-YD,
 - Diamantbohrungen, nur für ungerissenen Beton,
 - Diamantbohren mit Aufrauen mit Hilti Aufrauwerkzeug TE-YRT.
- Einbaurichtung D3: Einbau nach unten, horizontal und nach oben (z. B. über Kopf) für alle Elemente zulässig.
- Einbau der Befestigungsmittel durch entsprechend qualifiziertes Personal und unter Aufsicht der für die Technik verantwortlichen Person der Baustelle.

Injektionssystem Hilti HIT-RE 500 V4

Verwendungszweck
Spezifikationen

Anhang B2

Tabelle B1: Einbauparameter für metrische Gewindestangen gemäß Anhang A

Metrische Gewindestange gemäß Anhang A			M8	M10	M12	M16	M20	M24	M27	M30
Durchmesser des Elements	d	[mm]	8	10	12	16	20	24	27	30
Nenn Durchmesser der Bohrkronen	d_0	[mm]	10	12	14	18	22	28	30	35
Effektive Verankerungstiefe und Bohrlochtiefe	h_{ef}	[mm]	60 bis 160	60 bis 200	70 bis 240	80 bis 320	90 bis 400	96 bis 480	108 bis 540	120 bis 600
Maximaler Durchmesser des Durchgangslochs im Anbauteil	d_f	[mm]	9	12	14	18	22	26	30	33
Dicke des Hilti Verfüll-Sets	h_{fs}	[mm]	8	9	10	11	13	15	-	-
Effektive Dicke des Anbauteils mit Hilti Verfüll-Set	$t_{fix,eff}$	[mm]	$t_{fix,eff} = t_{fix} + h_{fs}$							
Minimale Dicke des Betonelements	h_{min}	[mm]	$h_{ef} + 30$ $\geq 100 \text{ mm}$			$h_{ef} + 2 \cdot d_0$				
Maximales Anzugsdrehmoment	$\max. T_{inst}$	[Nm]	10	20	40	80	150	200	270	300
Minimaler Achsabstand	s_{min}	[mm]	40	50	60	75	90	115	120	140
Minimaler Randabstand	c_{min}	[mm]	40	45	45	50	55	60	75	80

Tabelle B2: Einbauparameter für Zoll-Gewindestangen gemäß Anhang A

Zoll-Gewindestange gemäß Anhang A			3/8	1/2	5/8	3/4	7/8	1	1 1/4
Durchmesser des Elements	d	[mm]	9,5	12,7	15,9	19,1	22,2	25,4	31,8
Nenn Durchmesser der Bohrkronen	d_0	[in.]	7/16	9/16	3/4	7/8	1	1 1/8	1 3/8
Effektive Querschnittsfläche	$A_s^{1)}$	[mm ²]	50	92	146	216	298	391	625
Effektive Verankerungstiefe und Bohrlochtiefe	h_{ef}	[mm]	60 bis 191	70 bis 254	79 bis 318	89 bis 381	89 bis 445	102 bis 508	127 bis 635
Maximaler Durchmesser des Durchgangslochs im Anbauteil	d_f	[mm]	11,1	14,3	17,5	20,6	23,8	28,6	34,9
Minimale Dicke des Betonelements	h_{min}	[mm]	$h_{ef} + 30$ $\geq 100 \text{ mm}$		$h_{ef} + 2 \cdot d_0$				
Maximales Anzugsdrehmoment	$\max. T_{inst}$	[Nm]	20	41	81	136	169	203	271
Minimaler Achsabstand	s_{min}	[mm]	45	60	80	90	105	115	140
Minimaler Randabstand	c_{min}	[mm]	45	45	50	55	60	70	80

1) Effektive Querschnittsfläche für die Berechnung des charakteristischen Stahlwiderstands.

Injektionssystem Hilti HIT-RE 500 V4

Verwendungszweck
 Einbauparameter

Anhang B1

Tabelle B3: Einbauparameter der Innengewindehülse HIS-(R)N

HIS-(R)N		M8	M10	M12	M16	M20
Außendurchmesser der Hülse	d [mm]	12,5	16,5	20,5	25,4	27,6
Nenndurchmesser der Bohrkronen	d_0 [mm]	14	18	22	28	32
Effektive Verankerungstiefe und Bohrlochtiefe	h_{ef} [mm]	90	110	125	170	205
Maximaler Durchmesser des Durchgangslochs im Anbauteil ³⁾	d_f [mm]	9	12	14	18	22
Dicke des Hilti Verfüll-Sets	h_{fs} [mm]	8	9	10	11	13
Effektive Dicke des Anbauteils mit Hilti Verfüll-Set	$t_{fix,eff}$ [mm]	$t_{fix,eff} = t_{fix} + h_{fs}$				
Minimale Dicke des Betonelementes	h_{min} [mm]	120	150	170	230	270
Maximales Anzugsdrehmoment	$max. T_{inst}$ [Nm]	10	20	40	80	150
Länge des Gewindeeingriffs Min.-Max.	h_s [mm]	8 bis 20	10 bis 25	12 bis 30	16 bis 40	20 bis 50
Minimaler Achsabstand	s_{min} [mm]	60	75	90	115	130
Minimaler Randabstand	c_{min} [mm]	40	45	55	65	90

Tabelle B4: Einbauparameter der Innengewindehülse HIS-(R)N

HIS-(R)N, Größe	[in.]	3/8	1/2	5/8	3/4
Außendurchmesser der Hülse	d [mm]	16,5	20,5	25,4	27,6
Nenndurchmesser der Bohrkronen	d_0 [in.]	11/16	7/8	1 1/8	1
Effektive Verankerungstiefe und Bohrlochtiefe	h_{ef} [mm]	110	125	170	205
Maximaler Durchmesser des Durchgangslochs im Anbauteil	d_f [mm]	11,1	14,3	17,5	20,6
Mindeststärke des Betonelementes	h_{min} [mm]	150	170	230	270
Maximales Anzugsdrehmoment	$max. T_{inst}$ [Nm]	20	41	81	136
Länge des Gewindeeingriffs Min. bis Max.	h_s [mm]	10 bis 25	12 bis 30	16 bis 40	20 bis 50
Minimaler Achsabstand	s_{min} [mm]	70	90	115	130
Minimaler Randabstand	c_{min} [mm]	45	55	65	90

Injektionssystem Hilti HIT-RE 500 V4

Verwendungszweck
 Einbauparameter

Anhang B2

Tabelle B5: Einbauparameter des Hilti Zugankers HZA / HZA-R

HZA			M12	M16	M20	M24	M27	
HZA-R			M12	M16	M20	M24	-	
Durchmesser des Betonstahls	ϕ	[mm]	12	16	20	25	28	
Nominale Verankerungstiefe und Bohrlochtiefe HZA	h_0	[mm]	90 bis 240	100 bis 320	110 bis 400	120 bis 500	140 bis 560	
Nominale Verankerungstiefe und Bohrlochtiefe HZA-R	h_0	[mm]	170 bis 240	180 bis 320	190 bis 400	200 bis 500	-	
Effektive Verankerungstiefe HZA ($h_{ef} = h_{nom} - l_e$)	h_{ef}	[mm]	$h_{nom} - 20$					
Effektive Verankerungstiefe HZA-R ($h_{ef} = h_{nom} - l_e$)	h_{ef}	[mm]	$h_{nom} - 100$					
Länge des glatten Schafts HZA	l_e	[mm]	20					
Länge des glatten Schafts HZA-R	l_e	[mm]	100					
Nenn Durchmesser der Bohrkronen	d_0	[mm]	16	20	25	32	35	
Maximaler Durchmesser des Durchgangslochs im Anbauteil	d_f	[mm]	14	18	22	26	30	
Dicke des Hilti Verfüll-Sets	h_{fs}	[mm]	10	11	13	15	-	
Effektive Dicke des Anbauteils mit Hilti Verfüll-Set	$t_{fix,eff}$	[mm]	$t_{fix,eff} = t_{fix} - h_{fs}$					-
Maximales Anzugsdrehmoment	max. T_{inst}	[Nm]	40	80	150	200	270	
Minimale Dicke des Betonelements	h_{min}	[mm]	$h_{nom} + 2 \cdot d_0$					
Minimaler Achsabstand	s_{min}	[mm]	65	80	100	130	140	
Minimaler Randabstand	c_{min}	[mm]	45	50	55	60	75	

Tabelle B6: Einbauparameter des Bewehrungsstabs (Rebar)

Bewehrungsstab (Rebar)			$\phi 8$	$\phi 10$	$\phi 12$	$\phi 14$	$\phi 16$	$\phi 18$	$\phi 20$	$\phi 24$	$\phi 25$	$\phi 28$	$\phi 30$	$\phi 32$
Durchmesser	ϕ	[mm]	8	10	12	14	16	18	20	24	25	28	30	32
Effektive Verankerungstiefe und Bohrlochtiefe	h_{ef}	[mm]	60 bis 160	60 bis 200	70 bis 240	75 bis 280	80 bis 320	85 bis 360	90 bis 400	100 bis 480	100 bis 500	112 bis 560	120 bis 600	128 bis 640
Nenn Durchmesser der Bohrkronen	d_0	[mm]	10 ¹⁾ 12 ¹⁾	12 ¹⁾ 14 ¹⁾	14 ¹⁾ 16 ¹⁾	18	20	22	25	30 ¹⁾ 32 ¹⁾	30 ¹⁾ 32 ¹⁾	35	37	40
Minimale Dicke des Betonelements	h_{min}	[mm]	$h_{ef} + 30$ $\geq 100 \text{ mm}$			$h_{ef} + 2 \cdot d_0$								
Minimaler Achsabstand	s_{min}	[mm]	40	50	60	70	80	90	100	125	125	140	150	160
Minimaler Randabstand	c_{min}	[mm]	40	45	45	50	50	60	65	70	70	75	80	80

1) Jeder der beiden angegebenen Werte kann verwendet werden.

Injektionssystem Hilti HIT-RE 500 V4

Verwendungszweck
 Einbauparameter

Anhang B3

Tabelle B7: Verarbeitungs- und Aushärtezeit^{1) 2)}

Temperatur im Verankerungsgrund <i>T</i>	Maximale Verarbeitungszeit <i>t_{work}</i>	Minimale Aushärtezeit <i>t_{cure}</i> ¹⁾
-5 °C bis -1 °C	2 Stunden	168 Stunden
0 °C bis 4 °C	2 Stunden	48 Stunden
5 °C bis 9 °C	2 Stunden	24 Stunden
10 °C bis 14 °C	1,5 Stunden	16 Stunden
15 °C bis 19 °C	1 Stunde	12 Stunden
20 °C bis 24 °C	30 Minuten	7 Stunden
25 °C bis 29 °C	20 Minuten	6 Stunden
30 °C bis 34 °C	15 Minuten	5 Stunden
35 °C bis 39 °C	12 Minuten	4,5 Stunden
40 °C	10 Minuten	4 Stunden

1) Die Angaben zur Aushärtezeit gelten nur für trockenen Verankerungsgrund. Bei feuchtem Verankerungsgrund müssen die Aushärtezeiten verdoppelt werden.











2) Die Mindesttemperatur der Folienverpackung beträgt +5 °C.

Injektionssystem Hilti HIT-RE 500 V4

Verwendungszweck
 Verarbeitungs- und Aushärtezeit

Anhang B4

Tabelle B8: Reinigungs- und Setzwerkzeuge Hammerbohren und Pressluftbohren

Stahlelemente				Bohren und Reinigen					In- stallation
Metrische Gewinde- stange (Anhang A)	HIS-(R)N	Betonstahl	HZA(-R)	Hammerbohren		Diamantbohren		Bürste	Stau- zapfen HIT-SZ
					Hohlbohrer TE-CD, TE-YD ¹⁾		Aufrau- werkzeug TE-YRT		
									
Größe	Größe	Größe	Größe	d_0 [mm]	d_0 [mm]	d_0 [mm]	d_0 [mm]	HIT-RB	HIT-SZ
M8	-	$\phi 8$	-	10	10	10	-	10	-
M10	-	$\phi 8, \phi 10$	-	12	12	12	-	12	12
M12	M8	$\phi 10, \phi 12$	-	14	14	14	-	14	14
-	-	$\phi 12$	M12	16	16	16	-	16	16
M16	M10	$\phi 14$	-	18	18	18	18	18	18
-	-	$\phi 16$	M16	20	20	20	20	20	20
M20	M12	$\phi 18$	-	22	22	22	22	22	22
-	-	$\phi 20$	M20	25	25	25	25	25	25
M24	M16	-	-	28	28	28	28	28	28
M27	-	$\phi 24, \phi 25$	-	30	-	30	30	30	30
-	M20	$\phi 24, \phi 25$	M24	32	32	32	32	32	32
M30	-	$\phi 28$	M27	35	35	35	35	35	35
-	-	$\phi 30$	-	37	-	37	-	37	37
-	-	$\phi 32$	-	40	-	-	-	40	40
-	-			-	-	42	-	42	42









¹⁾ Mit Staubsauger Hilti VC 10/20/40 (automatische Filterreinigung aktiviert, Eco-Modus aus) oder einem Staubsauger mit gleichwertiger Reinigungsleistung in Kombination mit dem angegebenen Hilti Hohlbohrer TE-CD oder TE YD.

Injektionssystem Hilti HIT-RE 500 V4

Verwendungszweck
 Übersicht der Einbaumöglichkeiten / Parameter der Reinigungs- und Setzwerkzeuge

Anhang B5

Tabelle B9: Reinigungs- und Setzwerkzeuge Hammerbohren und Pressluftbohren

Stahlelemente		Bohren und Reinigen					Montage
Zoll-Gewindestange (Anhang A)	HIS-(R)N	Hammerbohren		Diamantbohren		Bürste	Stauzapfen HIT-SZ
			Hohlbohrer TE- CD, TE-YD ¹⁾		Aufrau- werkzeug TE-YRT		
							
Größe [in.]	Größe [in.]	d_0 [in.]	d_0 [in.]	d_0 [in.]	d_0 [in.]	HIT-RB	HIT-SZ
3/8	-	7/16	-	7/16	-	7/16	7/16
1/2	-	9/16	9/16	9/16	-	9/16	9/16
-	3/8	11/16	-	11/16	-	11/16	11/16
5/8	-	3/4	3/4	3/4	3/4	3/4	3/4
3/4	1/2	7/8	7/8	7/8	7/8	7/8	7/8
7/8	-	1	1	1	1	1	1
1	5/8	1 1/8	1 1/8	1 1/8	1 1/8	1 1/8	1 1/8
-	3/4	1 1/4	-	1 1/4	-	1 1/4	1 1/4
1 1/4	-	1 3/8	-	1 3/8	1 3/8	1 3/8	1 3/8

¹⁾ Mit Staubsauger Hilti VC 10/20/40 (automatische Filterreinigung aktiviert, Eco-Modus aus) oder einem Staubsauger mit gleichwertiger Reinigungsleistung in Kombination mit dem angegebenen Hilti Hohlbohrer TE-CD oder TE YD.

Injektionssystem Hilti HIT-RE 500 V4

Verwendungszweck
 Übersicht der Einbaumöglichkeiten / Parameter der Reinigungs- und Setzwerkzeuge

Anhang B6

Tabelle B10: Methoden der Bohrlochreinigung

Druckluftreinigung (CAC):

Ausblasdüse mit einer Düsenöffnung mit Mindestdurchmesser 3,5 mm (1/7").



Automatische Reinigung (AC):

Die Reinigung erfolgt während des Bohrvorgangs mit Hilti Bohrsystem TE-CD und TE-YD inklusive Staubsauger.



Tabelle B11: Kennwerte für die Verwendung des Aufrauwerkzeugs Hilti TE-YRT

Diamantbohren			Aufrauwerkzeug TE-YRT		Abnutzungslehre RTG...	
d_0					Größe	
nominal [mm]	nominal [in.]	gemessen [mm]	d_0 [mm]	d_0 [in.]		
18	3/4	17,9 bis 18,2	18	3/4	18	3/4
20	7/8	19,9 bis 20,2	20	7/8	20	7/8
22	1	21,9 bis 22,2	22	1	22	1
25	1 1/8	24,9 bis 25,2	25	1 1/8	25	1 1/8
28	1 3/8	27,9 bis 28,2	28	1 3/8	28	1 3/8
30	-	29,9 bis 30,2	30	-	30	-
32	-	31,9 bis 32,2	32	-	32	-
35	-	34,9 bis 35,2	35	-	35	-

Tabelle B12: Kennwerte für die Verwendung des Aufrauwerkzeugs Hilti TE-YRT

h_{ef} [mm]	Aufrauzeit $t_{roughen}$ ($t_{roughen}$ [s] = h_{ef} [mm] / 10)
0 bis 100	10
101 bis 200	20
201 bis 300	30
301 bis 400	40
401 bis 500	50
501 bis 600	60

Tabelle B13: Hilti Aufrauwerkzeug TE-YRT und Abnutzungslehre RTG



Injektionssystem Hilti HIT-RE 500 V4

Verwendungszweck
 Reinigungsalternativen / Parameter für den Einsatz des Aufrauwerkzeugs

Anhang B7

Montageanweisungen

Bohrlocherstellung

a) Hammerbohren: Für trockenen oder nassen Beton und den Einbau in wassergefüllte Bohrlöcher (kein

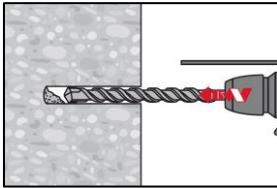

Die Bohrlocherstellung bis zur erforderlichen Verankerungstiefe erfolgt drehschlagend mithilfe eines Bohrhammers unter Verwendung eines Bohrers mit passendem Bohrerdurchmesser.

b) Hammerbohren mit Hilti Hohlbohrer TE-CD, TE-YD: Nur für trockenen und nassen Beton.

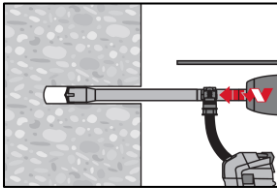

Bohren Sie das Loch bis zur erforderlichen Verankerungstiefe mit einem Hilti Hohlbohrer TE-CD oder TE-YD in Verbindung mit einem Hilti Staubsauger VC 10/20/40 (automatische Filterreinigung aktiviert, Eco-Modus aus) oder einem Staubsauger mit gleichwertiger Leistung in Kombination mit dem angegebenen Hilti Hohlbohrer TE-CD oder TE-YD. Dieses Bohrsystem entfernt den Staub und reinigt das Bohrloch während des Bohrens, wenn es in Übereinstimmung mit der Betriebsanleitung verwendet wird. Nach Beendigung des Bohrens fortfahren mit dem Schritt „Injektionsvorbereitung“ der Montageanweisung.

c) Diamantbohren: Nur für trockenen und nassen Beton.

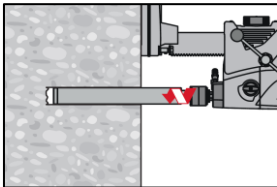

Diamantbohren ist zulässig, wenn passende Diamantbohrmaschinen und entsprechende Diamantkernbohrer verwendet werden.

d) Diamantbohren mit Aufrauen mit Hilti Aufrauwerkzeug TE-YRT: Nur für trockenen und nassen Beton.

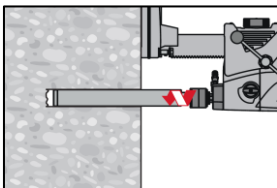

Diamantbohren ist zulässig, wenn passende Diamantbohrmaschinen und entsprechende Diamantkernbohrer verwendet werden.

Kennwerte zur Verwendung in Kombination mit dem Hilti Aufrauwerkzeug TE-YRT siehe Tabelle B8 und Tabelle B9.

Vor dem Aufrauen muss das freie Wasser aus dem Bohrloch entfernt werden.

Verwendbarkeit des Aufrauwerkzeugs prüfen mit der Abnutzungslehre RTG.

Das Bohrloch aufrauen über die gesamte Bohrtiefe bis zur geforderten Setztiefe h_{ef} .

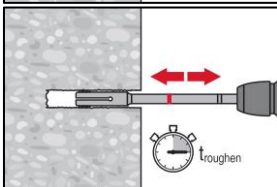

Injektionssystem Hilti HIT-RE 500 V4

Verwendungszweck
Montageanweisungen

Anhang B8

Bohrlochreinigung: Unmittelbar vor dem Setzen des Stahlelements muss das Bohrloch frei von Bohrmehl und Verunreinigungen sein.
Unzureichende Bohrlochreinigung = schlechte Lastwerte.

Druckluftreinigung (CAC): Für alle Bohrlochdurchmesser d_0 und alle Bohrlochtiefen h_0 .

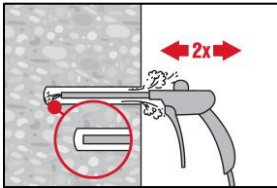

2 mal Blasen vom Bohrlochgrund her (falls erforderlich mit Düsenverlängerung) über die gesamte Bohrtiefe mit ölfreier Druckluft (min. 6 bar bei 6 m³/h), bis die rückströmende Luft frei von erkennbarem Staub ist.
Für Bohrlochdurchmesser ≥ 32 mm muss der Kompressor eine Mindest-Druckluftmenge von 140 m³/h liefern.

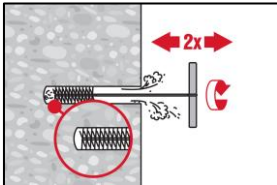

2 mal mit Stahlbürste Hilti HIT-RB passender Größe bürsten (siehe Tabelle B8 und Tabelle B9), wobei die Stahlbürste mit einer Drehbewegung in das Bohrloch bis zum Bohrlochgrund (falls erforderlich mit Verlängerung) eingeführt und wieder herausgezogen wird.
Die Bürste muss beim Einführen in das Bohrloch einen merkbaren Widerstand erzeugen (Bürsten- $\phi \geq$ Bohrloch- ϕ). Falls dies nicht der Fall ist, ist die Bürste zu klein und es muss eine Bürste mit passendem Durchmesser verwendet werden.

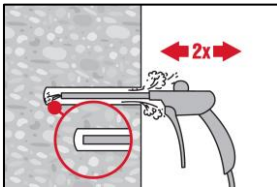

Erneut 2 Mal mit Druckluft ausblasen, bis die rückströmende Luft frei von sichtbarem Staub ist.

Injektionssystem Hilti HIT-RE 500 V4

Verwendungszweck
Montageanweisungen

Anhang B9

Reinigung und Entfernung von Wasser aus wassergefüllten Bohrlöchern beim Hammerbohren, Hammerbohren mit Hilti Hohlbohrer und Diamantbohrung

Für alle Bohrlochdurchmesser d_0 und alle Bohrlochtiefen h_0 .

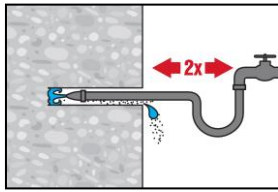

2 mal durch Einführen eines Wasserschlauches (Wasserleitungsdruck) bis zum Bohrlochgrund ausspülen, bis das herausströmende Wasser klar ist.

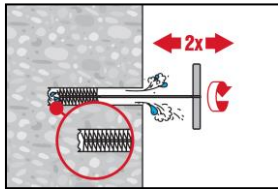

2 mal mit Stahlbürste Hilti HIT-RB passender Größe bürsten (siehe Tabelle B8 und Tabelle B9), wobei die Stahlbürste mit einer Drehbewegung in das Bohrloch bis zum Bohrlochgrund (falls erforderlich mit Verlängerung) eingeführt und wieder herausgezogen wird.
Die Bürste muss beim Einführen in das Bohrloch einen merkbaren Widerstand erzeugen (Bürsten- $\phi \geq$ Bohrloch- ϕ). Falls dies nicht der Fall ist, ist die Bürste zu klein und es muss eine Bürste mit passendem Durchmesser verwendet werden.

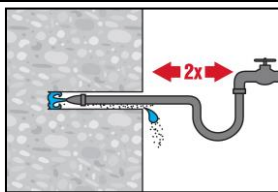

2 mal durch Einführen eines Wasserschlauches (Wasserleitungsdruck) bis zum Bohrlochgrund ausspülen, bis das herausströmende Wasser klar ist.

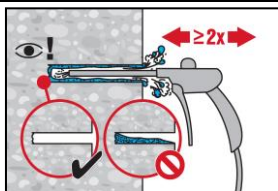

2 mal ausblasen mit ölfreier Druckluft (min. 6 bar bei 6 m³/h) vom Bohrlochgrund her über die gesamte Bohrlochtiefe (falls erforderlich mit Düsenverlängerung), bis die rückströmende Luft frei von erkennbarem Staub und Wasser ist.
Für Bohrlochdurchmesser ≥ 32 mm muss der Kompressor eine Mindest-Druckluftmenge von 140 m³/h liefern.

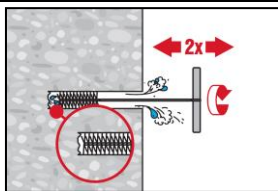

2 mal mit Stahlbürste Hilti HIT-RB passender Größe bürsten (siehe Tabelle B8 und Tabelle B9), wobei die Stahlbürste mit einer Drehbewegung in das Bohrloch bis zum Bohrlochgrund (falls erforderlich mit Verlängerung) eingeführt und wieder herausgezogen wird.
Die Bürste muss beim Einführen in das Bohrloch einen merkbaren Widerstand erzeugen. Falls dies nicht der Fall ist, ist die Bürste zu klein und es muss eine Bürste mit passendem Durchmesser verwendet werden.

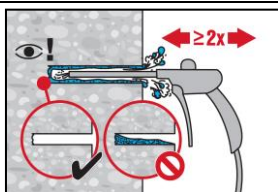

Blasen Sie erneut 2 Mal mit Druckluft aus, bis der Rückluftstrom frei von sichtbarem Staub und Wasser ist.

Injektionssystem Hilti HIT-RE 500 V4

Verwendungszweck
Montageanweisungen

Anhang B10

Reinigung von diamantgebohrten Bohrlöchern mit Aufrauen mit dem Hilti Aufrauwerkzeug TE-YRT:

Für alle Bohrlochdurchmesser d_0 und alle Bohrlochtiefen h_0 .

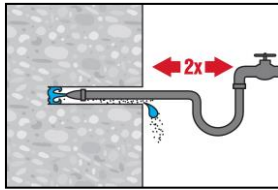

2 mal durch Einführen eines Wasserschlauches (Wasserleitungsdruck) bis zum Bohrlochgrund ausspülen, bis das herausströmende Wasser klar ist.

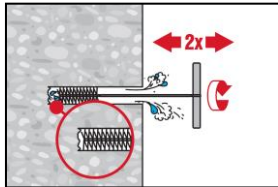

2 mal mit Stahlbürste Hilti HIT-RB passender Größe bürsten (siehe Tabelle B8 und Tabelle B9), wobei die Stahlbürste mit einer Drehbewegung in das Bohrloch bis zum Bohrlochgrund (falls erforderlich mit Verlängerung) eingeführt und wieder herausgezogen wird.

Die Bürste muss beim Einführen in das Bohrloch einen merkbaren Widerstand erzeugen (Bürsten- $\phi \geq$ Bohrloch- ϕ). Falls dies nicht der Fall ist, ist die Bürste zu klein und es muss eine Bürste mit passendem Durchmesser verwendet werden.

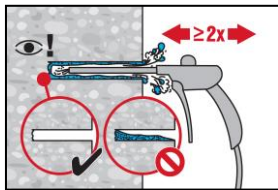

2 mal ausblasen mit ölfreier Druckluft (min. 6 bar bei 6 m³/h) vom Bohrlochgrund her über die gesamte Bohrlochtiefe (falls erforderlich mit Düsenverlängerung), bis die rückströmende Luft frei von erkennbarem Staub und Wasser ist.

Für Bohrlochdurchmesser ≥ 32 mm muss der Kompressor eine Mindest-Druckluftmenge von 140 m³/h liefern.

Injektionsvorbereitung

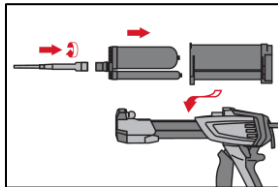

Den Mischeraufsatz Hilti HIT-RE-M fest auf das Anschlussstück des Foliengebindes aufschrauben. Den Mischeraufsatz nicht verändern.

Die Bedienungsanleitung des Auspressgerätes beachten.

Die Kassetten für das Foliengebinde auf einwandfreie Funktion prüfen. Das Foliengebinde in die Kassetten einlegen und diese in das Auspressgerät einsetzen.

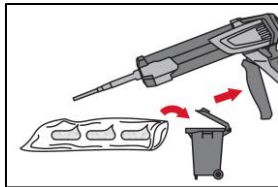

Das Öffnen des Foliengebindes erfolgt automatisch bei Auspressbeginn. Die Menge des zu verwendenden Mörtelvorlaufs ist abhängig von der Gebindegröße.

Folgende Mengen sind jeweils zu verwerfen:

3 Hübe	für 330 ml Folieneinlage,
4 Hübe	für 500 ml Folieneinlage,
65 ml	für 1400 ml Folieneinlage.

Die Mindesttemperatur der Folieneinlage beträgt +5 °C.

Injektionssystem Hilti HIT-RE 500 V4

Verwendungszweck
Montageanweisungen

Anhang B11

Injektion des Mörtels vom Bohrlochgrund her, ohne Lufteinschlüsse zu bilden.

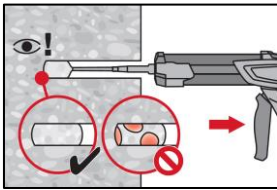

Injizieren des Mörtels vom Bohrlochgrund her. Den Mischer während jedes Hubs langsam etwas herausziehen.
Das Bohrloch zu ca. 2/3 verfüllen, um sicherzustellen, dass der Ringspalt zwischen Stahlelement und dem Beton über die gesamte Einbindetiefe vollständig mit Mörtel ausgefüllt ist.

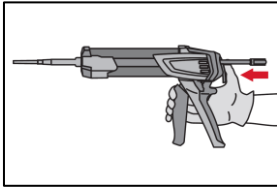

Nach Abschluss der Injektion die Entriegelungstaste am Auspressgerät betätigen, um Mörtelnachlauf zu verhindern. So wird eine weitere Abgabe von Mörtel aus dem Mischer verhindert.

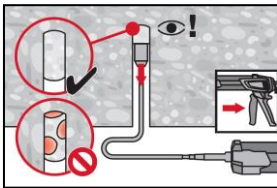

Überkopfmontage und/oder Montage mit Einbindetiefe $h_{ef} > 250$ mm.
Bei Überkopfanwendungen ist das Injizieren des Mörtels nur mithilfe von Mischerverlängerung(en) und Stauzapfen möglich. Mischer HIT-RE-M, Mischerverlängerung(en) und Stauzapfen der passenden Größe zusammenfügen (siehe Tabelle B8 und Tabelle B9). Den Stauzapfen bis zum Bohrlochgrund einführen und Mörtel injizieren. Während der Injektion wird der Stauzapfen über den Staudruck vom Bohrlochgrund her automatisch aus dem Bohrloch geschoben.

Einsetzen des Stahlelements

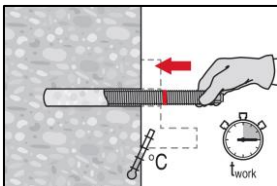

Vor der Verwendung sicherstellen, dass das Stahlelement trocken und frei von Öl und anderen Verunreinigungen ist.
Stahlelement markieren und setzen und bis zur erforderlichen Einbindetiefe einführen, bevor die Verarbeitungszeit t_{work} verstrichen ist. Die Verarbeitungszeit t_{work} ist in Tabelle B7 angegeben.

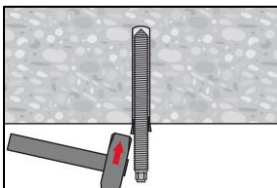

Für den Überkopfeinbau die eingebetteten Teile fixieren z. B. mit Keilen.

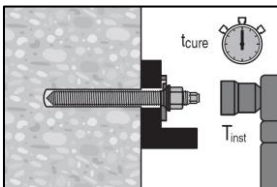

Nach der erforderlichen Aushärtezeit t_{cure} (siehe Tabelle B7) kann die Befestigung belastet werden.
Das aufzubringende Anzugsdrehmoment darf die in Tabelle B1 bis B5 angegebenen Maximalwerte T_{inst} nicht überschreiten.

Injektionssystem Hilti HIT-RE 500 V4

Verwendungszweck
Montageanweisungen

Anhang B12

Einbau von Hilti Verfüll-Set

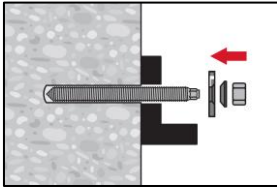

Verwenden Sie das Hilti Verfüll-Set mit einer Standard-Mutter. Achten Sie auf die richtige Ausrichtung von Füllscheibe und Kugelscheibe.

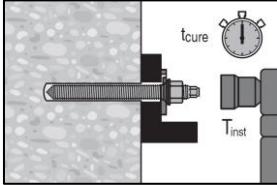

Das aufzubringende Anzugsdrehmoment darf die in Tabelle B1 bis B5 angegebenen Maximalwerte T_{inst} nicht überschreiten.

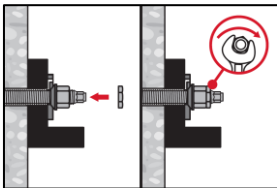

Optional:
Einbau einer Kontermutter. Ziehen Sie sie mit einer $\frac{1}{4}$ bis $\frac{1}{2}$ Umdrehung an. (Nicht bei Größe M24.)

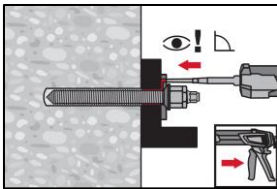

Füllen Sie den Ringspalt zwischen Ankerstange und Anbauteil mit 1-3 Hüben eines Hilti Injektionsmörtels HIT-HY ... oder HIT-RE
Befolgen Sie die mit dem Hilti Injektionsmörtel gelieferte Einbauanleitung.
Nach der erforderlichen Aushärtezeit t_{cure} kann die Befestigung belastet werden.

Injektionssystem Hilti HIT-RE 500 V4

Verwendungszweck
Montageanweisungen

Anhang B13

Tabelle C1: Wesentliche Merkmale für metrische Gewindestangen gemäß Anhang A unter Zugbelastung in Beton

Metrische Gewindestange gemäß Anhang A			M8	M10	M12	M16	M20	M24	M27	M30	
Für eine Nutzungsdauer von 50 und 100 Jahren											
Stahlversagen											
Charakteristischer Widerstand	$N_{Rk,s}$	[kN]	$A_s \cdot f_{uk}$								
Teilsicherheitsbeiwert der Festigkeitsklassen 5.8, 6.8, 8.8 (Tabelle A2)	$\gamma_{Ms,N}^{1)}$	[-]	1,5								
Teilsicherheitsbeiwert HAS A4, HAS-U A4, HIT-V-R, Gewindestange: CRC II und III (Tabelle A2)	$\gamma_{Ms,N}^{1)}$	[-]	1,87						2,86		
Teilsicherheitsbeiwert HAS-U HCR, HIT-V-HCR, Gewindestange: CRC V (Tabelle A2)	$\gamma_{Ms,N}^{1)}$	[-]	1,5						2,1		
Montagesicherheitsbeiwert											
Hammerbohren	γ_{inst}	[-]	1,0								
Hammerbohren mit Hilti Hohlbohrer TE-CD oder TE-YD	γ_{inst}	[-]	1,0								
Diamantbohren	γ_{inst}	[-]	1,2				1,4				
Diamantbohren mit Aufrauen mit Aufrauwerkzeug Hilti TE-YRT	γ_{inst}	[-]	2)				1,0				
Hammerbohren in wassergefüllten Bohrlöchern	γ_{inst}	[-]	1,4								
Betonausbruch											
Faktor für gerissenen Beton	$k_{cr,N}$	[-]	7,7								
Faktor für ungerissenen Beton	$k_{ucr,N}$	[-]	11,0								
Randabstand	$c_{cr,N}$	[mm]	$1,5 \cdot h_{ef}$								
Achsabstand	$s_{cr,N}$	[mm]	$3,0 \cdot h_{ef}$								
Spaltversagen											
Randabstand $c_{cr,sp}$ [mm] für	$h/h_{ef} \geq 2,0$		$1,0 \cdot h_{ef}$								
	$2,0 > h/h_{ef} > 1,3$		$4,6 \cdot h_{ef} - 1,8 \cdot h$								
	$h/h_{ef} \leq 1,3$		$2,26 \cdot h_{ef}$								
Achsabstand	$s_{cr,sp}$	[mm]	$2 \cdot c_{cr,sp}$								

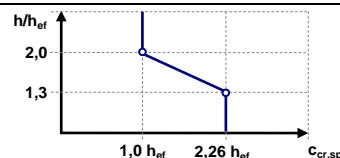

Injektionssystem Hilti HIT-RE 500 V4

Leistung
 Wesentliche Eigenschaften unter Zugbelastung in Beton

Anhang C1

Tabelle C1: Fortsetzung (1)

Metrische Gewindestange gemäß Anhang A	M8	M10	M12	M16	M20	M24	M27	M30	
Kombiniertes Herausziehen und Betonversagen für eine Lebensdauer von 50 Jahren									
Charakteristischer Widerstand in ungerissenem Beton C20/25 in Hammerbohrlöchern und Hammerbohrlöchern mit Hilti Hohlbohrer TE-CD oder TE-YD und Diamantbohrlöchern mit Aufrauung durch das Hilti Aufrauwerkzeug TE-YRT									
Temperaturbereich I: 24 °C / 40 °C	$\tau_{Rk,ucr}$ [N/mm ²]	19	18	18	17	16	15	14	
Temperaturbereich II: 43 °C / 55 °C	$\tau_{Rk,ucr}$ [N/mm ²]	16	15	15	14	13	12	12	
Temperaturbereich III: 55 °C / 75 °C	$\tau_{Rk,ucr}$ [N/mm ²]	6,0	6,0	6,0	5,5	5,0	4,5	4,5	
Charakteristischer Widerstand in ungerissenem Beton C20/25 in Diamantbohrungen									
Temperaturbereich I: 24 °C / 40 °C	$\tau_{Rk,ucr}$ [N/mm ²]	13	13	13	13	12	12	12	
Temperaturbereich II: 43 °C / 55 °C	$\tau_{Rk,ucr}$ [N/mm ²]	12	12	11	11	11	11	10	
Temperaturbereich III: 55 °C / 75 °C	$\tau_{Rk,ucr}$ [N/mm ²]	6,0	5,5	5,5	5,5	5,5	5,5	5,0	
Charakteristischer Widerstand in ungerissenem Beton C20/25 in Hammerbohrlöchern und Einbau in wassergefüllten Bohrlöchern									
Temperaturbereich I: 24 °C / 40 °C	$\tau_{Rk,ucr}$ [N/mm ²]	16	16	15	15	14	13	12	
Temperaturbereich II: 43 °C / 55 °C	$\tau_{Rk,ucr}$ [N/mm ²]	13	13	13	12	11	11	10	
Temperaturbereich III: 55 °C / 75 °C	$\tau_{Rk,ucr}$ [N/mm ²]	5,0	5,0	5,0	4,5	4,5	4,0	4,0	
Charakteristischer Widerstand in gerissenem Beton C20/25 in Hammerbohrlöchern und Hammerbohrlöchern mit Hilti Hohlbohrer TE-CD oder TE-YD und Diamantbohrlöchern mit Aufrauung durch das Hilti Aufrauwerkzeug TE-YRT									
Temperaturbereich I: 24 °C / 40 °C	$\tau_{Rk,cr}$ [N/mm ²]	7,5	9,0	11	11	10	9,5	9,0	
Temperaturbereich II: 43 °C / 55 °C	$\tau_{Rk,cr}$ [N/mm ²]	7,0	8,0	9,0	8,5	8,0	8,0	7,5	
Temperaturbereich III: 55 °C / 75 °C	$\tau_{Rk,cr}$ [N/mm ²]	4,0	3,5	3,5	3,5	3,0	3,0	3,0	
Einflussfaktoren ψ auf den Verbundtragfähigkeit τ_{Rk} in gerissenem und ungerissenem Beton									
Einfluss der Betonfestigkeit									
in Hammerbohrlöchern und Hammerbohrlöchern mit Hilti Hohlbohrer TE-CD oder TE-YD und Diamantbohrungen									
Temperaturbereich I bis III:	ψ_c [-]	$(f_{ck}/20)^{0,1}$							
in Diamantbohrlöchern mit Aufrauung durch das Hilti Aufrauwerkzeug TE-YRT									
Temperaturbereich I bis III:	ψ_c [-]	2)					1,0		
Einfluss von Dauerbelastung									
in Hammerbohrlöchern und Hammerbohrlöchern mit Hilti Hohlbohrer TE-CD oder TE-YD und Diamantbohrlöchern mit Aufrauung durch das Hilti Aufrauwerkzeug TE-YRT									
Temperaturbereich I: 24 °C / 40 °C	ψ_{sus}^0 [-]	0,88							
Temperaturbereich II: 43 °C / 55 °C	ψ_{sus}^0 [-]	0,72							
Temperaturbereich III: 55 °C / 75 °C	ψ_{sus}^0 [-]	0,69							
in Diamantbohrungen									
Temperaturbereich I: 24 °C / 40 °C	ψ_{sus}^0 [-]	0,89							
Temperaturbereich II: 43 °C / 55 °C	ψ_{sus}^0 [-]	0,70							
Temperaturbereich III: 55 °C / 75 °C	ψ_{sus}^0 [-]	0,62							

Injektionssystem Hilti HIT-RE 500 V4

Leistung
 Wesentliche Eigenschaften unter Zugbelastung in Beton

Anhang C2

Tabelle C1: Fortsetzung (2)

Metrische Gewindestange gemäß Anhang A	M8	M10	M12	M16	M20	M24	M27	M30	
Kombiniertes Herausziehen und Betonversagen für eine Lebensdauer von 100 Jahren									
Charakteristischer Widerstand in ungerissenem Beton C20/25 in Hammerbohrlöchern und Hammerbohrlöchern mit Hilti Hohlbohrer TE-CD oder TE-YD und Diamantbohrlöchern mit Aufrauung durch das Hilti Aufrauwerkzeug TE-YRT									
Temperaturbereich I: 24 °C / 40 °C	$\tau_{Rk,100,uc}$ [N/mm ²]	19	18	18	17	16	15	14	
Temperaturbereich II: 43 °C / 55 °C	$\tau_{Rk,100,uc}$ [N/mm ²]	15	15	15	14	13	13	12	
Temperaturbereich III: 55 °C / 75 °C	$\tau_{Rk,100,uc}$ [N/mm ²]	6,0	6,0	6,0	5,5	5,0	5,0	4,5	
Charakteristischer Widerstand in ungerissenem Beton C20/25 in Diamantbohrungen									
Temperaturbereich I: 24 °C / 40 °C	$\tau_{Rk,100,uc}$ [N/mm ²]	13	13	13	13	12	12	12	
Temperaturbereich II: 43 °C / 55 °C	$\tau_{Rk,100,uc}$ [N/mm ²]	12	12	11	11	11	11	10	
Temperaturbereich III: 55 °C / 75 °C	$\tau_{Rk,100,uc}$ [N/mm ²]	6,0	5,5	5,5	5,5	5,5	5,5	5,0	
Charakteristischer Widerstand in ungerissenem Beton C20/25 in Hammerbohrlöchern und Einbau in wassergefüllten Bohrlöchern									
Temperaturbereich I: 24 °C / 40 °C	$\tau_{Rk,100,uc}$ [N/mm ²]	16	16	15	15	14	13	12	
Temperaturbereich II: 43 °C / 55 °C	$\tau_{Rk,100,uc}$ [N/mm ²]	13	13	13	12	11	11	10	
Temperaturbereich III: 55 °C / 75 °C	$\tau_{Rk,100,uc}$ [N/mm ²]	5,0	5,0	5,0	4,5	4,5	4,0	4,0	
Charakteristischer Widerstand in gerissenem Beton C20/25 in Hammerbohrlöchern und Hammerbohrlöchern mit Hilti Hohlbohrer TE-CD oder TE-YD und Diamantbohrlöchern mit Aufrauung durch das Hilti Aufrauwerkzeug TE-YRT									
Temperaturbereich I: 24 °C / 40 °C	$\tau_{Rk,100,cr}$ [N/mm ²]	7,0	8,0	9,0	8,5	8,0	7,5	7,0	
Temperaturbereich II: 43 °C / 55 °C	$\tau_{Rk,100,cr}$ [N/mm ²]	6,0	7,0	8,0	7,5	7,0	6,5	6,0	
Temperaturbereich III: 55 °C / 75 °C	$\tau_{Rk,100,cr}$ [N/mm ²]	4,0	3,5	3,5	3,5	3,0	3,0	3,0	
Einflussfaktoren ψ auf den Verbundtragfähigkeit $\tau_{Rk,100}$ in gerissenem und ungerissenem Beton									
Einfluss der Betonfestigkeit									
in Hammerbohrlöchern und Hammerbohrlöchern mit Hilti Hohlbohrer TE-CD oder TE-YD und Diamantbohrungen									
Temperaturbereich I bis III:	ψ_c [-]	$(f_{ck}/20)^{0,1}$							
in Diamantbohrlöchern mit Aufrauung durch das Hilti Aufrauwerkzeug TE-YRT									
Temperaturbereich I bis III:	ψ_c [-]	2)					1,0		
Einfluss von Dauerbelastung									
in Hammerbohrlöchern und Hammerbohrlöchern mit Hilti Hohlbohrer TE-CD oder TE-YD und Diamantbohrlöchern mit Aufrauung durch das Hilti Aufrauwerkzeug TE-YRT									
Temperaturbereich I: 24 °C / 40 °C	$\psi_{sus,100}^0$ [-]	0,85							
Temperaturbereich II: 43 °C / 55 °C	$\psi_{sus,100}^0$ [-]	0,72							
Temperaturbereich III: 55 °C / 75 °C	$\psi_{sus,100}^0$ [-]	0,69							
in Diamantbohrungen									
Temperaturbereich I: 24 °C / 40 °C	$\psi_{sus,100}^0$ [-]	0,70							
Temperaturbereich II: 43 °C / 55 °C	$\psi_{sus,100}^0$ [-]	0,67							
Temperaturbereich III: 55 °C / 75 °C	$\psi_{sus,100}^0$ [-]	0,62							

1) Soweit es keine nationalen Vorschriften gibt.

2) Keine Leistung bewertet.

Injektionssystem Hilti HIT-RE 500 V4

Leistung
 Wesentliche Eigenschaften unter Zugbelastung in Beton

Anhang C3

Tabelle C2: Wesentliche Merkmale für Zoll-Gewindestangen gemäß Anhang A unter Zugbelastung in Beton

Zoll-Gewindestange gemäß Anhang A		[in.]	3/8	1/2	5/8	3/4	7/8	1	1 1/4
Für eine Nutzungsdauer von 50 und 100 Jahren									
Stahlversagen									
Charakteristischer Widerstand	$N_{Rk,s}$	[kN]	$A_s \cdot f_{uk}$						
Teilsicherheitsbeiwert HIT-V	$\gamma_{Ms,N}^{1)}$	[-]	1,92						
Teilsicherheitsbeiwert HAS-V-36	$\gamma_{Ms,N}^{1)}$	[-]	1,94						
Teilsicherheitsbeiwert HAS-E-55	$\gamma_{Ms,N}^{1)}$	[-]	1,64						
Teilsicherheitsbeiwert HAS-B-105	$\gamma_{Ms,N}^{1)}$	[-]	1,43						
Teilsicherheitsbeiwert HAS-R 304	$\gamma_{Ms,N}^{1)}$	[-]	1,85		2,27			3,01	
Teilsicherheitsbeiwert HAS-R 316	$\gamma_{Ms,N}^{1)}$	[-]	1,85		2,27				
Montagesicherheitsbeiwert									
Hammerbohren	γ_{inst}	[-]	1,0						
Hammerbohren mit Hilti Hohlbohrer TE-CD oder TE-YD	γ_{inst}	[-]	2)	1,0					
Diamantbohren	γ_{inst}	[-]	1,2		1,4				
Diamantbohren mit Aufrauen mit Aufrauwerkzeug Hilti TE-YRT	γ_{inst}	[-]	2)	1,0					
Hammerbohren in wassergefüllten Bohrlöchern	γ_{inst}	[-]	1,4						
Betonausbruch									
Faktor für gerissenen Beton	$k_{cr,N}$	[-]	7,7						
Faktor für ungerissenen Beton	$k_{ucr,N}$	[-]	11,0						
Randabstand	$c_{cr,N}$	[mm]	$1,5 \cdot h_{ef}$						
Achsabstand	$s_{cr,N}$	[mm]	$3,0 \cdot h_{ef}$						
Spaltversagen									
Randabstand $c_{cr,sp}$ [mm] für	$h/h_{ef} \geq 2,0$		$1,0 \cdot h_{ef}$						
	$2,0 > h/h_{ef} > 1,3$		$4,6 \cdot h_{ef} - 1,8 \cdot h$						
	$h/h_{ef} \leq 1,3$		$2,26 \cdot h_{ef}$						
Achsabstand	$s_{cr,sp}$	[mm]	$2 \cdot c_{cr,sp}$						

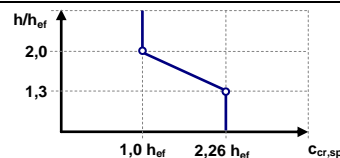

Injektionssystem Hilti HIT-RE 500 V4

Leistung
 Wesentliche Eigenschaften unter Zugbelastung in Beton

Anhang C4

Tabelle C2: Fortsetzung (1)

Zoll-Gewindestange gemäß Anhang A	[in.]	3/8	1/2	5/8	3/4	7/8	1	1 1/4		
Kombiniertes Herausziehen und Betonversagen für eine Lebensdauer von 50 Jahren										
Charakteristischer Widerstand in ungerissenem Beton C20/25 in Hammerbohrlöchern und Hammerbohrlöchern mit Hilti Hohlbohrer TE-CD oder TE-YD und Diamantbohrlöchern mit Aufrauung durch das Hilti Aufrauwerkzeug TE-YRT										
Temperaturbereich I:	24 °C / 40 °C	$\tau_{RK,ucr}$	[N/mm ²]	19	18	17	16	16	15	14
Temperaturbereich II:	43 °C / 55 °C	$\tau_{RK,ucr}$	[N/mm ²]	15	15	14	14	13	12	11
Temperaturbereich III:	55 °C / 75 °C	$\tau_{RK,ucr}$	[N/mm ²]	6,0	6,0	5,5	5,5	5,0	5,0	4,5
Charakteristischer Widerstand in ungerissenem Beton C20/25 in Diamantbohrungen										
Temperaturbereich I:	24 °C / 40 °C	$\tau_{RK,ucr}$	[N/mm ²]	13	13	13	12	12	12	12
Temperaturbereich II:	43 °C / 55 °C	$\tau_{RK,ucr}$	[N/mm ²]	12	11	11	11	11	11	10
Temperaturbereich III:	55 °C / 75 °C	$\tau_{RK,ucr}$	[N/mm ²]	5,5	5,5	5,5	5,5	5,5	5,5	5,0
Charakteristischer Widerstand in ungerissenem Beton C20/25 in Hammerbohrlöchern und Einbau in wassergefüllten Bohrlöchern										
Temperaturbereich I:	24 °C / 40 °C	$\tau_{RK,ucr}$	[N/mm ²]	16	15	15	14	13	13	12
Temperaturbereich II:	43 °C / 55 °C	$\tau_{RK,ucr}$	[N/mm ²]	13	13	12	12	11	11	9,5
Temperaturbereich III:	55 °C / 75 °C	$\tau_{RK,ucr}$	[N/mm ²]	5,0	5,0	4,5	4,5	4,5	4,0	3,5
Charakteristischer Widerstand in gerissenem Beton C20/25 in Hammerbohrlöchern und Hammerbohrlöchern mit Hilti Hohlbohrer TE-CD oder TE-YD und Diamantbohrlöchern mit Aufrauung durch das Hilti Aufrauwerkzeug TE-YRT										
Temperaturbereich I:	24 °C / 40 °C	$\tau_{RK,cr}$	[N/mm ²]	9,0	11	11	10	9,0	9,0	8,5
Temperaturbereich II:	43 °C / 55 °C	$\tau_{RK,cr}$	[N/mm ²]	8,0	9,0	8,5	8,5	8,0	7,5	7,0
Temperaturbereich III:	55 °C / 75 °C	$\tau_{RK,cr}$	[N/mm ²]	3,5	3,5	3,5	3,0	3,0	3,0	2,5
Einflussfaktoren ψ auf den Verbundtragfähigkeit τ_{RK} in gerissenem und ungerissenem Beton										
Einfluss der Betonfestigkeit										
in Hammerbohrlöchern und Hammerbohrlöchern mit Hilti Hohlbohrer TE-CD oder TE-YD und Diamantbohrungen										
Temperaturbereich I bis III:	ψ_c	[-]		$(f_{ck}/20)^{0,1}$						
in Diamantbohrlöchern mit Aufrauung durch das Hilti Aufrauwerkzeug TE-YRT										
Temperaturbereich I bis III:	ψ_c	[-]		2)		1,0				
Einfluss von Dauerbelastung										
in Hammerbohrlöchern und Hammerbohrlöchern mit Hilti Hohlbohrer TE-CD oder TE-YD und Diamantbohrlöchern mit Aufrauung durch das Hilti Aufrauwerkzeug TE-YRT										
Temperaturbereich I:	24 °C / 40 °C	ψ_{sus}^0	[-]	0,88						
Temperaturbereich II:	43 °C / 55 °C	ψ_{sus}^0	[-]	0,72						
Temperaturbereich III:	55 °C / 75 °C	ψ_{sus}^0	[-]	0,69						
in Diamantbohrungen										
Temperaturbereich I:	24 °C / 40 °C	ψ_{sus}^0	[-]	0,89						
Temperaturbereich II:	43 °C / 55 °C	ψ_{sus}^0	[-]	0,70						
Temperaturbereich III:	55 °C / 75 °C	ψ_{sus}^0	[-]	0,62						

Injektionssystem Hilti HIT-RE 500 V4

Leistung
 Wesentliche Eigenschaften unter Zugbelastung in Beton

Anhang C5

Tabelle C2: Fortsetzung (2)

Zoll-Gewindestange gemäß Anhang A	[in.]	3/8	1/2	5/8	3/4	7/8	1	1 1/4	
Kombiniertes Herausziehen und Betonversagen für eine Lebensdauer von 100 Jahren									
Charakteristischer Widerstand in ungerissenem Beton C20/25 in Hammerbohrlöchern und Hammerbohrlöchern mit Hilti Hohlbohrer TE-CD oder TE-YD und Diamantbohrlöchern mit Aufrauung durch das Hilti Aufrauwerkzeug TE-YRT									
Temperaturbereich I:	24 °C / 40 °C	$\tau_{Rk,100,uc}$ [N/mm ²]	19	18	17	16	16	15	14
Temperaturbereich II:	43 °C / 55 °C	$\tau_{Rk,100,uc}$ [N/mm ²]	15	15	14	13	13	12	11
Temperaturbereich III:	55 °C / 75 °C	$\tau_{Rk,100,uc}$ [N/mm ²]	6,0	6,0	5,5	5,5	5,0	5,0	4,5
Charakteristischer Widerstand in ungerissenem Beton C20/25 in Diamantbohrungen									
Temperaturbereich I:	24 °C / 40 °C	$\tau_{Rk,100,uc}$ [N/mm ²]	13	13	13	12	12	12	12
Temperaturbereich II:	43 °C / 55 °C	$\tau_{Rk,100,uc}$ [N/mm ²]	12	11	11	11	11	11	10
Temperaturbereich III:	55 °C / 75 °C	$\tau_{Rk,100,uc}$ [N/mm ²]	5,5	5,5	5,5	5,5	5,5	5,5	5,0
Charakteristischer Widerstand in ungerissenem Beton C20/25 in Hammerbohrlöchern und Einbau in wassergefüllten Bohrlöchern									
Temperaturbereich I:	24 °C / 40 °C	$\tau_{Rk,100,uc}$ [N/mm ²]	16	15	15	14	13	13	12
Temperaturbereich II:	43 °C / 55 °C	$\tau_{Rk,100,uc}$ [N/mm ²]	13	12	12	11	11	10	9,5
Temperaturbereich III:	55 °C / 75 °C	$\tau_{Rk,100,uc}$ [N/mm ²]	5,0	5,0	4,5	4,5	4,5	4,0	3,5
Charakteristischer Widerstand in gerissenem Beton C20/25 in Hammerbohrlöchern und Hammerbohrlöchern mit Hilti Hohlbohrer TE-CD oder TE-YD und Diamantbohrlöchern mit Aufrauung durch das Hilti Aufrauwerkzeug TE-YRT									
Temperaturbereich I:	24 °C / 40 °C	$\tau_{Rk,100,cr}$ [N/mm ²]	8,0	8,5	8,5	8,0	7,5	7,5	6,5
Temperaturbereich II:	43 °C / 55 °C	$\tau_{Rk,100,cr}$ [N/mm ²]	7,0	7,5	7,5	7,0	7,0	6,5	6,0
Temperaturbereich III:	55 °C / 75 °C	$\tau_{Rk,100,cr}$ [N/mm ²]	3,5	3,5	3,5	3,0	3,0	3,0	2,5
Einflussfaktoren ψ auf den Verbundtragfähigkeit $\tau_{Rk,100}$ in gerissenem und ungerissenem Beton									
Einfluss der Betonfestigkeit									
in Hammerbohrlöchern und Hammerbohrlöchern mit Hilti Hohlbohrer TE-CD oder TE-YD und Diamantbohrungen									
Temperaturbereich I bis III:	ψ_c	[-]	$(f_{ck}/20)^{0,1}$						
in Diamantbohrlöchern mit Aufrauung durch das Hilti Aufrauwerkzeug TE-YRT									
Temperaturbereich I bis III:	ψ_c	[-]	2)			1,0			
Einfluss von Dauerbelastung									
in Hammerbohrlöchern und Hammerbohrlöchern mit Hilti Hohlbohrer TE-CD oder TE-YD und Diamantbohrlöchern mit Aufrauung durch das Hilti Aufrauwerkzeug TE-YRT									
Temperaturbereich I:	24 °C / 40 °C	$\psi_{sus,100}^0$	[-]	0,85					
Temperaturbereich II:	43 °C / 55 °C	$\psi_{sus,100}^0$	[-]	0,72					
Temperaturbereich III:	55 °C / 75 °C	$\psi_{sus,100}^0$	[-]	0,69					
in Diamantbohrungen									
Temperaturbereich I:	24 °C / 40 °C	$\psi_{sus,100}^0$	[-]	0,70					
Temperaturbereich II:	43 °C / 55 °C	$\psi_{sus,100}^0$	[-]	0,67					
Temperaturbereich III:	55 °C / 75 °C	$\psi_{sus,100}^0$	[-]	0,62					

1) Soweit es keine nationalen Vorschriften gibt.

2) Keine Leistung bewertet.

Injektionssystem Hilti HIT-RE 500 V4

Leistung
Wesentliche Eigenschaften unter Zugbelastung in Beton

Anhang C6

Tabelle C3: Wesentliche Merkmale für Innengewindehülsen HIS-(R)N unter Zugbelastung in Beton

HIS-(R)N		M8	M10	M12	M16	M20
Außendurchmesser der Hülse	d_{nom} [mm]	12,5	16,5	20,5	25,4	27,6
Für eine Nutzungsdauer von 50 und 100 Jahren						
Stahlversagen						
Charakteristischer Widerstand HIS-N mit Schraube Festigkeitsklasse 8.8	$N_{Rk,s}$ [kN]	25	46	67	125	116
Teilsicherheitsbeiwert	$\gamma_{Ms,N}^{1)}$ [-]	1,5				
Charakteristischer Widerstand HIS-RN mit Schraube Klasse 70	$N_{Rk,s}$ [kN]	26	41	59	110	166
Teilsicherheitsbeiwert	$\gamma_{Ms,N}^{1)}$ [-]	1,87				2,4
Montagesicherheitsbeiwert						
Hammerbohren	γ_{inst} [-]	1,0				
Hammerbohren mit Hilti Hohlbohrer TE-CD oder TE-YD	γ_{inst} [-]	1,0				
Diamantbohren	γ_{inst} [-]	1,2	1,4			
Diamantbohren mit Aufrauen mit Aufrauwerkzeug Hilti TE-YRT	γ_{inst} [-]	2)	1,0			
Hammerbohren in wassergefüllten Bohrlöchern	γ_{inst} [-]	1,4				
Betonausbruch						
Faktor für gerissen Beton	$k_{cr,N}$ [-]	7,7				
Faktor für ungerissenen Beton	$k_{ucr,N}$ [-]	11,0				
Randabstand	$c_{cr,N}$ [mm]	$1,5 \cdot h_{ef}$				
Achsabstand	$s_{cr,N}$ [mm]	$3,0 \cdot h_{ef}$				
Spaltversagen						
Randabstand $c_{cr,sp}$ [mm] für	$h/h_{ef} \geq 2,0$	$1,0 \cdot h_{ef}$				
	$2,0 > h/h_{ef} > 1,3$	$4,6 \cdot h_{ef} - 1,8 \cdot h$				
	$h/h_{ef} \leq 1,3$	$2,26 \cdot h_{ef}$				
Achsabstand	$s_{cr,sp}$ [mm]	$2 \cdot c_{cr,sp}$				

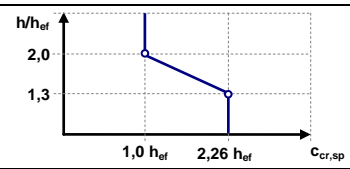

Injektionssystem Hilti HIT-RE 500 V4

Leistung
 Wesentliche Eigenschaften unter Zugbelastung in Beton

Anhang C7

Tabelle C3: Fortsetzung (1)

HIS-(R)N		M8	M10	M12	M16	M20
Außendurchmesser der Hülse	d_{nom} [mm]	12,5	16,5	20,5	25,4	27,6
Kombiniertes Herausziehen und Betonversagen für eine Lebensdauer von 50 Jahren						
Charakteristischer Widerstand in ungerissemem Beton C20/25 in Hammerbohrlöchern und Hammerbohrlöchern mit Hilti Hohlbohrer TE-CD oder TE-YD und Diamantbohrlöchern mit Aufrauung durch das Hilti Aufrauwerkzeug TE-YRT						
Temperaturbereich I:	24 °C / 40 °C	$\tau_{Rk,ucr}$ [N/mm ²]	14	14	14	14
Temperaturbereich II:	43 °C / 55 °C	$\tau_{Rk,ucr}$ [N/mm ²]	12	12	12	12
Temperaturbereich III:	55 °C / 75 °C	$\tau_{Rk,ucr}$ [N/mm ²]	4,5	4,5	4,5	4,5
Charakteristischer Widerstand in ungerissemem Beton C20/25 in Diamantbohrungen						
Temperaturbereich I:	24 °C / 40 °C	$\tau_{Rk,ucr}$ [N/mm ²]	8,5	9,0	9,5	10
Temperaturbereich II:	43 °C / 55 °C	$\tau_{Rk,ucr}$ [N/mm ²]	8,0	8,0	8,5	9,0
Temperaturbereich III:	55 °C / 75 °C	$\tau_{Rk,ucr}$ [N/mm ²]	4,0	4,0	4,0	4,5
Charakteristischer Widerstand in ungerissemem Beton C20/25 in Hammerbohrlöchern und Einbau in wassergefüllten Bohrlöchern						
Temperaturbereich I:	24 °C / 40 °C	$\tau_{Rk,ucr}$ [N/mm ²]	12	12	12	12
Temperaturbereich II:	43 °C / 55 °C	$\tau_{Rk,ucr}$ [N/mm ²]	10	10	10	10
Temperaturbereich III:	55 °C / 75 °C	$\tau_{Rk,ucr}$ [N/mm ²]	4,0	4,0	4,0	4,0
Charakteristischer Widerstand in gerissemem Beton C20/25 in Hammerbohrlöchern und Hammerbohrlöchern mit Hilti Hohlbohrer TE-CD oder TE-YD und Diamantbohrlöchern mit Aufrauung durch das Hilti Aufrauwerkzeug TE-YRT						
Temperaturbereich I:	24 °C / 40 °C	$\tau_{Rk,cr}$ [N/mm ²]	9,0	9,0	9,0	9,0
Temperaturbereich II:	43 °C / 55 °C	$\tau_{Rk,cr}$ [N/mm ²]	8,0	8,0	8,0	8,0
Temperaturbereich III:	55 °C / 75 °C	$\tau_{Rk,cr}$ [N/mm ²]	3,0	3,0	3,0	3,0
Einflussfaktoren ψ auf den Verbundtragfähigkeit τ_{Rk} in gerissemem und nicht gerissemem Beton						
Einfluss der Betonfestigkeit						
in Hammerbohrlöchern und Hammerbohrlöchern mit Hilti Hohlbohrer TE-CD oder TE-YD und Diamantbohrungen						
Temperaturbereich I bis III:	ψ_c	[-]	$(f_{ck}/20)^{0,1}$			
in Diamantbohrlöchern mit Aufrauung durch das Hilti Aufrauwerkzeug TE-YRT						
Temperaturbereich I bis III:	ψ_c	[-]	2)	1,0		
Einfluss von Dauerbelastung						
in Hammerbohrlöchern und Hammerbohrlöchern mit Hilti Hohlbohrer TE-CD oder TE-YD und Diamantbohrlöchern mit Aufrauung durch das Hilti Aufrauwerkzeug TE-YRT						
Temperaturbereich I:	24 °C / 40 °C	ψ_{sus}^0	[-]	0,88		
Temperaturbereich II:	43 °C / 55 °C	ψ_{sus}^0	[-]	0,72		
Temperaturbereich III:	55 °C / 75 °C	ψ_{sus}^0	[-]	0,69		
in Diamantbohrungen						
Temperaturbereich I:	24 °C / 40 °C	ψ_{sus}^0	[-]	0,89		
Temperaturbereich II:	43 °C / 55 °C	ψ_{sus}^0	[-]	0,70		
Temperaturbereich III:	55 °C / 75 °C	ψ_{sus}^0	[-]	0,62		

Injektionssystem Hilti HIT-RE 500 V4

Leistung
 Wesentliche Eigenschaften unter Zugbelastung in Beton

Anhang C8

Tabelle C3: Fortsetzung (2)

HIS-(R)N	M8	M10	M12	M16	M20
Außendurchmesser der Hülse d_{nom} [mm]	12,5	16,5	20,5	25,4	27,6
Kombiniertes Herausziehen und Betonversagen für eine Lebensdauer von 100 Jahren					
Charakteristischer Widerstand in ungerissemem Beton C20/25 in Hammerbohrlöchern und Hammerbohrlöchern mit Hilti Hohlbohrer TE-CD oder TE-YD und Diamantbohrlöchern mit Aufrauung durch das Hilti Aufrauwerkzeug TE-YRT					
Temperaturbereich I: 24 °C / 40 °C $\tau_{Rk,100,ucr}$ [N/mm ²]	14	14	14	14	14
Temperaturbereich II: 43 °C / 55 °C $\tau_{Rk,100,ucr}$ [N/mm ²]	11	11	11	11	11
Temperaturbereich III: 55 °C / 75 °C $\tau_{Rk,100,ucr}$ [N/mm ²]	4,5	4,5	4,5	4,5	4,5
Charakteristischer Widerstand in ungerissemem Beton C20/25 in Diamantbohrungen					
Temperaturbereich I: 24 °C / 40 °C $\tau_{Rk,100,ucr}$ [N/mm ²]	8,5	9,0	9,5	10	10
Temperaturbereich II: 43 °C / 55 °C $\tau_{Rk,100,ucr}$ [N/mm ²]	8,0	8,0	8,5	9,0	9,0
Temperaturbereich III: 55 °C / 75 °C $\tau_{Rk,100,ucr}$ [N/mm ²]	4,0	4,0	4,0	4,5	4,5
Charakteristischer Widerstand in ungerissemem Beton C20/25 in Hammerbohrlöchern und Einbau in wassergefüllten Bohrlöchern					
Temperaturbereich I: 24 °C / 40 °C $\tau_{Rk,100,ucr}$ [N/mm ²]	12	12	12	12	12
Temperaturbereich II: 43 °C / 55 °C $\tau_{Rk,100,ucr}$ [N/mm ²]	9,5	9,5	9,5	9,5	9,5
Temperaturbereich III: 55 °C / 75 °C $\tau_{Rk,100,ucr}$ [N/mm ²]	4,0	4,0	4,0	4,0	4,0
Charakteristischer Widerstand in gerissemem Beton C20/25 in Hammerbohrlöchern und Hammerbohrlöchern mit Hilti Hohlbohrer TE-CD oder TE-YD und Diamantbohrlöchern mit Aufrauung durch das Hilti Aufrauwerkzeug TE-YRT					
Temperaturbereich I: 24 °C / 40 °C $\tau_{Rk,100,cr}$ [N/mm ²]	7,0	7,0	7,0	7,0	7,0
Temperaturbereich II: 43 °C / 55 °C $\tau_{Rk,100,cr}$ [N/mm ²]	6,0	6,5	6,5	6,5	6,5
Temperaturbereich III: 55 °C / 75 °C $\tau_{Rk,100,cr}$ [N/mm ²]	3,0	3,0	3,0	3,0	3,0
Einflussfaktoren ψ auf den Verbundtragfähigkeit $\tau_{Rk,100}$ in gerissen und ungerissemem Beton					
Einfluss der Betonfestigkeit					
in Hammerbohrlöchern und Hammerbohrlöchern mit Hilti Hohlbohrer TE-CD oder TE-YD und Diamantbohrungen					
Temperaturbereich I bis III: ψ_c [-]	$(f_{ck}/20)^{0,1}$				
in Diamantbohrlöchern mit Aufrauung durch das Hilti Aufrauwerkzeug TE-YRT					
Temperaturbereich I bis III: ψ_c [-]	2)		1,0		
Einfluss von Dauerbelastung					
in Hammerbohrlöchern und Hammerbohrlöchern mit Hilti Hohlbohrer TE-CD oder TE-YD und Diamantbohrlöchern mit Aufrauung durch das Hilti Aufrauwerkzeug TE-YRT					
Temperaturbereich I: 24 °C / 40 °C $\psi_{sus,100}^0$ [-]	0,85				
Temperaturbereich II: 43 °C / 55 °C $\psi_{sus,100}^0$ [-]	0,72				
Temperaturbereich III: 55 °C / 75 °C $\psi_{sus,100}^0$ [-]	0,69				
in Diamantbohrungen					
Temperaturbereich I: 24 °C / 40 °C $\psi_{sus,100}^0$ [-]	0,70				
Temperaturbereich II: 43 °C / 55 °C $\psi_{sus,100}^0$ [-]	0,67				
Temperaturbereich III: 55 °C / 75 °C $\psi_{sus,100}^0$ [-]	0,62				

1) Soweit es keine nationalen Vorschriften gibt.

2) Keine Leistung bewertet.

Injektionssystem Hilti HIT-RE 500 V4

Leistung
 Wesentliche Eigenschaften unter Zugbelastung in Beton

Anhang C9

Tabelle C4: Wesentliche Merkmale für Innengewindehülsen HIS-(R)N unter Zugbelastung in Beton

HIS-(R)N, Größe	[in.]	3/8	1/2	5/8	3/4	
Außendurchmesser der Hülse	d_{nom}	[mm]	16,5	20,5	25,4	27,6
Für eine Nutzungsdauer von 50 und 100 Jahren						
Stahlversagen						
Charakteristischer Widerstand HIS-N Schraube gemäß SAE J429 Grade 5 oder ASTM A325 (1/2" bis 3/4")	$N_{Rk,s}$	[kN]	41	76	121	130
Teilsicherheitsbeiwert	$\gamma_{Ms,N}^{1)}$	[-]	1,57			1,50
Charakteristischer Widerstand HIS-N Schraube gemäß ASTM A193 Grade B7	$N_{Rk,s}$	[kN]	43	77	128	130
Teilsicherheitsbeiwert	$\gamma_{Ms,N}^{1)}$	[-]	1,43	1,50		
Charakteristischer Widerstand HIS-RN Schraube gemäß ASTM A193 Grade B8M	$N_{Rk,s}$	[kN]	38	110	182	185
Teilsicherheitsbeiwert	$\gamma_{Ms,N}^{1)}$	[-]	1,40	2,40		
Charakteristischer Widerstand HIS-RN Schraube gemäß ASTM A193 Grade B8T	$N_{Rk,s}$	[kN]	43	110	182	185
Teilsicherheitsbeiwert	$\gamma_{Ms,N}^{1)}$	[-]	1,50	2,40		
Montagesicherheitsbeiwert						
Hammerbohren	γ_{inst}	[-]	1,0			
Hammerbohren mit Hilti Hohlbohrer TE-CD oder TE-YD	γ_{inst}	[-]	2)	1,0	2)	
Diamantbohren	γ_{inst}	[-]	1,4			
Diamantbohren mit Aufrauen mit Aufrauwerkzeug Hilti TE-YRT	γ_{inst}	[-]	2)	1,0	2)	
Hammerbohren in wassergefüllten Bohrlöchern	γ_{inst}	[-]	1,4			
Betonausbruch						
Faktor für gerissenen Beton	$k_{cr,N}$	[-]	7,7			
Faktor für ungerissenen Beton	$k_{ucr,N}$	[-]	11,0			
Randabstand	$c_{cr,N}$	[mm]	$1,5 \cdot h_{ef}$			
Achsabstand	$s_{cr,N}$	[mm]	$3,0 \cdot h_{ef}$			
Spaltversagen						
Randabstand $c_{cr,sp}$ [mm] für	$h/h_{ef} \geq 2,0$		$1,0 \cdot h_{ef}$			
	$2,0 > h/h_{ef} > 1,3$		$4,6 \cdot h_{ef} - 1,8 \cdot h$			
	$h/h_{ef} \leq 1,3$		$2,26 \cdot h_{ef}$			
Achsabstand	$s_{cr,sp}$	[mm]	$2 \cdot c_{cr,sp}$			

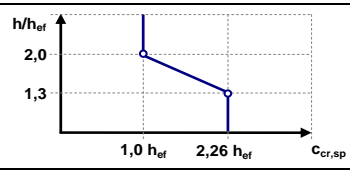

Injektionssystem Hilti HIT-RE 500 V4

Leistung
 Wesentliche Eigenschaften unter Zugbelastung in Beton

Anhang C10

Tabelle C4: Fortsetzung (1)

HIS-(R)N, Größe	[in.]	3/8	1/2	5/8	3/4
Außendurchmesser der Hülse	d_{nom} [mm]	16,5	20,5	25,4	27,6
Kombiniertes Herausziehen und Betonversagen für eine Lebensdauer von 50 Jahren					
Charakteristischer Widerstand in ungerissenem Beton C20/25 in Hammerbohrlöchern und Hammerbohrlöchern mit Hilti Hohlbohrer TE-CD oder TE-YD und Diamantbohrlöchern mit Aufrauung durch das Hilti Aufrauwerkzeug TE-YRT					
Temperaturbereich I:	24 °C / 40 °C	$\tau_{Rk,ucr}$ [N/mm ²]	14	14	14
Temperaturbereich II:	43 °C / 55 °C	$\tau_{Rk,ucr}$ [N/mm ²]	12	12	12
Temperaturbereich III:	55 °C / 75 °C	$\tau_{Rk,ucr}$ [N/mm ²]	4,5	4,5	4,5
Charakteristischer Widerstand in ungerissenem Beton C20/25 in Diamantbohrungen					
Temperaturbereich I:	24 °C / 40 °C	$\tau_{Rk,ucr}$ [N/mm ²]	9,0	9,5	10
Temperaturbereich II:	43 °C / 55 °C	$\tau_{Rk,ucr}$ [N/mm ²]	8,0	8,5	9,0
Temperaturbereich III:	55 °C / 75 °C	$\tau_{Rk,ucr}$ [N/mm ²]	4,0	4,0	4,5
Charakteristischer Widerstand in ungerissenem Beton C20/25 in Hammerbohrlöchern und Einbau in wassergefüllten Bohrlöchern					
Temperaturbereich I:	24 °C / 40 °C	$\tau_{Rk,ucr}$ [N/mm ²]	12	12	12
Temperaturbereich II:	43 °C / 55 °C	$\tau_{Rk,ucr}$ [N/mm ²]	10	10	10
Temperaturbereich III:	55 °C / 75 °C	$\tau_{Rk,ucr}$ [N/mm ²]	4,0	4,0	4,0
Charakteristischer Widerstand in gerissenem Beton C20/25 in Hammerbohrlöchern und Hammerbohrlöchern mit Hilti Hohlbohrer TE-CD oder TE-YD und Diamantbohrlöchern mit Aufrauung durch das Hilti Aufrauwerkzeug TE-YRT					
Temperaturbereich I:	24 °C / 40 °C	$\tau_{Rk,cr}$ [N/mm ²]	9,0	9,0	9,0
Temperaturbereich II:	43 °C / 55 °C	$\tau_{Rk,cr}$ [N/mm ²]	8,0	8,0	8,0
Temperaturbereich III:	55 °C / 75 °C	$\tau_{Rk,cr}$ [N/mm ²]	3,0	3,0	3,0
Einflussfaktoren ψ auf den Verbundtragfähigkeit τ_{Rk} in gerissenem und ungerissenem Beton					
Einfluss der Betonfestigkeit					
in Hammerbohrlöchern und Hammerbohrlöchern mit Hilti Hohlbohrer TE-CD oder TE-YD und Diamantbohrungen					
Temperaturbereich I bis III:	ψ_c	[-]	$(f_{ck}/20)^{0,1}$		
in Diamantbohrlöchern mit Aufrauung durch das Hilti Aufrauwerkzeug TE-YRT					
Temperaturbereich I bis III:	ψ_c	[-]	2)	1,0	2)
Einfluss von Dauerbelastung					
in Hammerbohrlöchern und Hammerbohrlöchern mit Hilti Hohlbohrer TE-CD oder TE-YD und Diamantbohrlöchern mit Aufrauung durch das Hilti Aufrauwerkzeug TE-YRT					
Temperaturbereich I:	24 °C / 40 °C	ψ_{sus}^0	[-]	0,88	
Temperaturbereich II:	43 °C / 55 °C	ψ_{sus}^0	[-]	0,72	
Temperaturbereich III:	55 °C / 75 °C	ψ_{sus}^0	[-]	0,69	
in Diamantbohrungen					
Temperaturbereich I:	24 °C / 40 °C	ψ_{sus}^0	[-]	0,89	
Temperaturbereich II:	43 °C / 55 °C	ψ_{sus}^0	[-]	0,70	
Temperaturbereich III:	55 °C / 75 °C	ψ_{sus}^0	[-]	0,62	

Injektionssystem Hilti HIT-RE 500 V4

Leistung
 Wesentliche Eigenschaften unter Zugbelastung in Beton

Anhang C11

Tabelle C4: Fortsetzung (2)

HIS-(R)N, Größe	[in.]	3/8	1/2	5/8	3/4
Außendurchmesser der Hülse	d_{nom} [mm]	16,5	20,5	25,4	27,6
Kombiniertes Herausziehen und Betonversagen für eine Lebensdauer von 100 Jahren					
Charakteristischer Widerstand in ungerissenem Beton C20/25 in Hammerbohrlöchern und Hammerbohrlöchern mit Hilti Hohlbohrer TE-CD oder TE-YD und Diamantbohrlöchern mit Aufrauung durch das Hilti Aufrauwerkzeug TE-YRT					
Temperaturbereich I:	24 °C / 40 °C	$\tau_{Rk,100,ucr}$ [N/mm ²]	14	14	14
Temperaturbereich II:	43 °C / 55 °C	$\tau_{Rk,100,ucr}$ [N/mm ²]	11	11	11
Temperaturbereich III:	55 °C / 75 °C	$\tau_{Rk,100,ucr}$ [N/mm ²]	4,5	4,5	4,5
Charakteristischer Widerstand in ungerissenem Beton C20/25 in Diamantbohrungen					
Temperaturbereich I:	24 °C / 40 °C	$\tau_{Rk,100,ucr}$ [N/mm ²]	9,0	9,5	10
Temperaturbereich II:	43 °C / 55 °C	$\tau_{Rk,100,ucr}$ [N/mm ²]	8,0	8,5	9,0
Temperaturbereich III:	55 °C / 75 °C	$\tau_{Rk,100,ucr}$ [N/mm ²]	4,0	4,0	4,5
Charakteristischer Widerstand in ungerissenem Beton C20/25 in Hammerbohrlöchern und Einbau in wassergefüllten Bohrlöchern					
Temperaturbereich I:	24 °C / 40 °C	$\tau_{Rk,100,ucr}$ [N/mm ²]	12	12	12
Temperaturbereich II:	43 °C / 55 °C	$\tau_{Rk,100,ucr}$ [N/mm ²]	9,5	9,5	9,5
Temperaturbereich III:	55 °C / 75 °C	$\tau_{Rk,100,ucr}$ [N/mm ²]	4,0	4,0	4,0
Charakteristischer Widerstand in gerissenem Beton C20/25 in Hammerbohrlöchern und Hammerbohrlöchern mit Hilti Hohlbohrer TE-CD oder TE-YD und Diamantbohrlöchern mit Aufrauung durch das Hilti Aufrauwerkzeug TE-YRT					
Temperaturbereich I:	24 °C / 40 °C	$\tau_{Rk,100,cr}$ [N/mm ²]	7,0	7,0	7,0
Temperaturbereich II:	43 °C / 55 °C	$\tau_{Rk,100,cr}$ [N/mm ²]	6,5	6,5	6,5
Temperaturbereich III:	55 °C / 75 °C	$\tau_{Rk,100,cr}$ [N/mm ²]	3,0	3,0	3,0
Einflussfaktoren ψ auf den Verbundtragfähigkeit $\tau_{Rk,100}$ in gerissenem und ungerissenem Beton					
Einfluss der Betonfestigkeit					
in Hammerbohrlöchern und Hammerbohrlöchern mit Hilti Hohlbohrer TE-CD oder TE-YD und Diamantbohrungen					
Temperaturbereich I bis III:	ψ_c	[-]	$(f_{ck}/20)^{0,1}$		
in Diamantbohrlöchern mit Aufrauung durch das Hilti Aufrauwerkzeug TE-YRT					
Temperaturbereich I bis III:	ψ_c	[-]	2)	1,0	2)
Einfluss von Dauerbelastung					
in Hammerbohrlöchern und Hammerbohrlöchern mit Hilti Hohlbohrer TE-CD oder TE-YD und Diamantbohrlöchern mit Aufrauung durch das Hilti Aufrauwerkzeug TE-YRT					
Temperaturbereich I:	24 °C / 40 °C	$\psi_{sus,100}^0$	[-]	0,85	
Temperaturbereich II:	43 °C / 55 °C	$\psi_{sus,100}^0$	[-]	0,72	
Temperaturbereich III:	55 °C / 75 °C	$\psi_{sus,100}^0$	[-]	0,69	
in Diamantbohrungen					
Temperaturbereich I:	24 °C / 40 °C	$\psi_{sus,100}^0$	[-]	0,70	
Temperaturbereich II:	43 °C / 55 °C	$\psi_{sus,100}^0$	[-]	0,67	
Temperaturbereich III:	55 °C / 75 °C	$\psi_{sus,100}^0$	[-]	0,62	

1) Soweit es keine nationalen Vorschriften gibt.

2) Keine Leistung bewertet.

Injektionssystem Hilti HIT-RE 500 V4

Leistung

Wesentliche Eigenschaften unter Zugbelastung in Beton

Anhang C12

Tabelle C5: Wesentliche Eigenschaften für Hilti Zuganker HZA / HZA-R unter Zugbelastung in Beton

HZA / HZA-R			M12	M16	M20	M24	M27		
Durchmesser des Betonstahls	ϕ	[mm]	12	16	20	25	28		
Für eine Nutzungsdauer von 50 und 100 Jahren									
Stahlversagen									
Charakteristischer Widerstand HZA	$N_{Rk,s}$	[kN]	46	86	135	194	253		
Charakteristischer Widerstand HZA-R	$N_{Rk,s}$	[kN]	62	111	173	248	1)		
Teilsicherheitsbeiwert	$\gamma_{Ms,N}$	1)	[-]					1,4	
Montagesicherheitsbeiwert									
Hammerbohren	γ_{inst}	[-]						1,0	
Hammerbohren mit Hilti Hohlbohrer TE-CD oder TE-YD	γ_{inst}	[-]						1,0	
Diamantbohren	γ_{inst}	[-]	1,2						1,4
Diamantbohren mit Aufrauen mit Aufrauwerkzeug Hilti TE-YRT	γ_{inst}	[-]	2)						1,0
Hammerbohren in wassergefüllten Bohrlöchern	γ_{inst}	[-]						1,4	
Betonausbruch									
Faktor für gerissen Beton	$k_{cr,N}$	[-]						7,7	
Faktor für ungerissenen Beton	$k_{ucr,N}$	[-]						11,0	
Randabstand	$c_{cr,N}$	[mm]						$1,5 \cdot h_{ef}$	
Achsabstand	$s_{cr,N}$	[mm]						$3,0 \cdot h_{ef}$	
Spaltversagen									
Randabstand $c_{cr,sp}$ [mm] für	$h/h_{ef} \geq 2,0$		$1,0 \cdot h_{ef}$						
	$2,0 > h/h_{ef} > 1,3$		$4,6 \cdot h_{ef} - 1,8 \cdot h$						
	$h/h_{ef} \leq 1,3$		$2,26 \cdot h_{ef}$						
Achsabstand	$s_{cr,sp}$	[mm]						$2 \cdot c_{cr,sp}$	

1) Soweit es keine nationalen Vorschriften gibt.
 2) Keine Leistung bewertet.

Injektionssystem Hilti HIT-RE 500 V4

Leistung
 Wesentliche Eigenschaften unter Zugbelastung in Beton

Anhang C13

Tabelle C5: Fortsetzung (1)

HZA / HZA-R	M12	M16	M20	M24	M27
Durchmesser des Betonstahls ϕ [mm]	12	16	20	25	28
Kombiniertes Herausziehen und Betonversagen für eine Lebensdauer von 50 Jahren					
Charakteristischer Widerstand in ungerissenem Beton C20/25 in Hammerbohrlöchern und Hammerbohrlöchern mit Hilti Hohlbohrer TE-CD oder TE-YD und Diamantbohrlöchern mit Aufrauung durch das Hilti Aufrauwerkzeug TE-YRT					
Temperaturbereich I: 24 °C / 40 °C $\tau_{Rk,ucr}$ [N/mm ²]	15	15	14	14	14
Temperaturbereich II: 43 °C / 55 °C $\tau_{Rk,ucr}$ [N/mm ²]	12	12	12	11	11
Temperaturbereich III: 55 °C / 75 °C $\tau_{Rk,ucr}$ [N/mm ²]	5,0	4,5	4,5	4,5	4,5
Charakteristischer Widerstand in ungerissenem Beton C20/25 in Diamantbohrungen					
Temperaturbereich I: 24 °C / 40 °C $\tau_{Rk,ucr}$ [N/mm ²]	9,5	9,5	9,5	9,5	10
Temperaturbereich II: 43 °C / 55 °C $\tau_{Rk,ucr}$ [N/mm ²]	8,5	8,5	8,5	8,5	8,5
Temperaturbereich III: 55 °C / 75 °C $\tau_{Rk,ucr}$ [N/mm ²]	4,0	4,0	4,0	4,5	4,5
Charakteristischer Widerstand in ungerissenem Beton C20/25 in Hammerbohrlöchern und Einbau in wassergefüllten Bohrlöchern					
Temperaturbereich I: 24 °C / 40 °C $\tau_{Rk,ucr}$ [N/mm ²]	13	12	12	12	12
Temperaturbereich II: 43 °C / 55 °C $\tau_{Rk,ucr}$ [N/mm ²]	11	10	10	10	9,5
Temperaturbereich III: 55 °C / 75 °C $\tau_{Rk,ucr}$ [N/mm ²]	4,0	4,0	4,0	4,0	3,5
Charakteristischer Widerstand in gerissenem Beton C20/25 in Hammerbohrlöchern und Hammerbohrlöchern mit Hilti Hohlbohrer TE-CD oder TE-YD und Diamantbohrlöchern mit Aufrauung durch das Hilti Aufrauwerkzeug TE-YRT					
Temperaturbereich I: 24 °C / 40 °C $\tau_{Rk,cr}$ [N/mm ²]	12	12	12	11	11
Temperaturbereich II: 43 °C / 55 °C $\tau_{Rk,cr}$ [N/mm ²]	10	10	10	9,5	9,5
Temperaturbereich III: 55 °C / 75 °C $\tau_{Rk,cr}$ [N/mm ²]	4,0	4,0	3,5	3,5	3,5
Einflussfaktoren ψ auf den Verbundtragfähigkeit τ_{Rk} in gerissenem und ungerissenem Beton					
Einfluss der Betonfestigkeit					
in Hammerbohrlöchern und Hammerbohrlöchern mit Hilti Hohlbohrer TE-CD oder TE-YD und Diamantbohrungen					
Temperaturbereich I bis III: ψ_c [-]	$(f_{ck}/20)^{0,1}$				
in Diamantbohrlöchern mit Aufrauung durch das Hilti Aufrauwerkzeug TE-YRT					
Temperaturbereich I bis III: ψ_c [-]	1)		1,0		
Einfluss von Dauerbelastung					
in Hammerbohrlöchern und Hammerbohrlöchern mit Hilti Hohlbohrer TE-CD oder TE-YD und Diamantbohrlöchern mit Aufrauung durch das Hilti Aufrauwerkzeug TE-YRT					
Temperaturbereich I: 24 °C / 40 °C ψ_{sus}^0 [-]					0,88
Temperaturbereich II: 43 °C / 55 °C ψ_{sus}^0 [-]					0,72
Temperaturbereich III: 55 °C / 75 °C ψ_{sus}^0 [-]					0,69
in Diamantbohrungen					
Temperaturbereich I: 24 °C / 40 °C ψ_{sus}^0 [-]					0,89
Temperaturbereich II: 43 °C / 55 °C ψ_{sus}^0 [-]					0,70
Temperaturbereich III: 55 °C / 75 °C ψ_{sus}^0 [-]					0,62

Injektionssystem Hilti HIT-RE 500 V4

Leistung
 Wesentliche Eigenschaften unter Zugbelastung in Beton

Anhang C14

Tabelle C5: Fortsetzung (2)

HZA / HZA-R	M12	M16	M20	M24	M27
Durchmesser des Betonstahls ϕ [mm]	12	16	20	25	28
Kombiniertes Herausziehen und Betonversagen für eine Lebensdauer von 100 Jahren					
Charakteristischer Widerstand in ungerissenem Beton C20/25 in Hammerbohrlöchern und Hammerbohrlöchern mit Hilti Hohlbohrer TE-CD oder TE-YD und Diamantbohrlöchern mit Aufrauung durch das Hilti Aufrauwerkzeug TE-YRT					
Temperaturbereich I: 24 °C / 40 °C $\tau_{Rk,100,ucr}$ [N/mm ²]	15	15	14	14	14
Temperaturbereich II: 43 °C / 55 °C $\tau_{Rk,100,ucr}$ [N/mm ²]	12	12	12	11	11
Temperaturbereich III: 55 °C / 75 °C $\tau_{Rk,100,ucr}$ [N/mm ²]	5,0	4,5	4,5	4,5	4,5
Charakteristischer Widerstand in ungerissenem Beton C20/25 in Diamantbohrungen					
Temperaturbereich I: 24 °C / 40 °C $\tau_{Rk,100,ucr}$ [N/mm ²]	9,5	9,5	9,5	9,5	10
Temperaturbereich II: 43 °C / 55 °C $\tau_{Rk,100,ucr}$ [N/mm ²]	8,5	8,5	8,5	8,5	8,5
Temperaturbereich III: 55 °C / 75 °C $\tau_{Rk,100,ucr}$ [N/mm ²]	4,0	4,0	4,0	4,5	4,5
Charakteristischer Widerstand in ungerissenem Beton C20/25 in Hammerbohrlöchern und Einbau in wassergefüllten Bohrlöchern					
Temperaturbereich I: 24 °C / 40 °C $\tau_{Rk,100,ucr}$ [N/mm ²]	13	12	12	12	12
Temperaturbereich II: 43 °C / 55 °C $\tau_{Rk,100,ucr}$ [N/mm ²]	10	10	10	9,5	9,5
Temperaturbereich III: 55 °C / 75 °C $\tau_{Rk,100,ucr}$ [N/mm ²]	4,0	4,0	4,0	4,0	3,5
Charakteristischer Widerstand in gerissenem Beton C20/25 in Hammerbohrlöchern und Hammerbohrlöchern mit Hilti Hohlbohrer TE-CD oder TE-YD und Diamantbohrlöchern mit Aufrauung durch das Hilti Aufrauwerkzeug TE-YRT					
Temperaturbereich I: 24 °C / 40 °C $\tau_{Rk,100,cr}$ [N/mm ²]	10	9,5	9,5	9,0	9,0
Temperaturbereich II: 43 °C / 55 °C $\tau_{Rk,100,cr}$ [N/mm ²]	9,0	8,5	8,5	8,0	8,0
Temperaturbereich III: 55 °C / 75 °C $\tau_{Rk,100,cr}$ [N/mm ²]	4,0	4,0	3,5	3,5	3,5
Einflussfaktoren ψ auf den Verbundtragfähigkeit $\tau_{Rk,100}$ in gerissenem und ungerissenem Beton					
Einfluss der Betonfestigkeit					
in Hammerbohrlöchern und Hammerbohrlöchern mit Hilti Hohlbohrer TE-CD oder TE-YD und Diamantbohrungen					
Temperaturbereich I bis III: ψ_c [-]	$(f_{ck}/20)^{0,1}$				
in Diamantbohrlöchern mit Aufrauung durch das Hilti Aufrauwerkzeug TE-YRT					
Temperaturbereich I bis III: ψ_c [-]	1)		1,0		
Einfluss von Dauerbelastung					
in Hammerbohrlöchern und Hammerbohrlöchern mit Hilti Hohlbohrer TE-CD oder TE-YD und Diamantbohrlöchern mit Aufrauung durch das Hilti Aufrauwerkzeug TE-YRT					
Temperaturbereich I: 24 °C / 40 °C $\psi_{sus,100}^0$ [-]	0,85				
Temperaturbereich II: 43 °C / 55 °C $\psi_{sus,100}^0$ [-]	0,72				
Temperaturbereich III: 55 °C / 75 °C $\psi_{sus,100}^0$ [-]	0,69				
in Diamantbohrungen					
Temperaturbereich I: 24 °C / 40 °C $\psi_{sus,100}^0$ [-]	0,70				
Temperaturbereich II: 43 °C / 55 °C $\psi_{sus,100}^0$ [-]	0,67				
Temperaturbereich III: 55 °C / 75 °C $\psi_{sus,100}^0$ [-]	0,62				

1) Keine Leistung bewertet.

Injektionssystem Hilti HIT-RE 500 V4

Leistung
 Wesentliche Eigenschaften unter Zugbelastung in Beton

Anhang C15

Tabelle C6: Wesentliche Eigenschaften für Bewehrungsstäbe (Rebars) unter Zugbelastung in Beton

Bewehrungsstab (Rebar)	$\phi 8$	$\phi 10$	$\phi 12$	$\phi 14$	$\phi 16$	$\phi 18$	$\phi 20$	$\phi 24$	$\phi 25$	$\phi 28$	$\phi 30$	$\phi 32$		
Für eine Nutzungsdauer von 50 und 100 Jahren														
Stahlversagen														
Charakteristischer Widerstand	$N_{Rk,s}$	[kN]	$A_s \cdot f_{uk}^{1)}$											
Charakteristischer Widerstand Rebar B500B gemäß DIN 488 ²⁾	$N_{Rk,s}$	[kN]	28	43	62	85	111	140	173	249	270	339	389	442
Teilsicherheitsbeiwert Bewehrungsstahl B500B gemäß DIN 488 ³⁾	$\gamma_{Ms,N}^{4)}$	[-]	1,4											
Montagesicherheitsbeiwert														
Hammerbohren	γ_{inst}	[-]	1,0											
Hammerbohren mit Hilti Hohlbohrer TE-CD oder TE-YD	γ_{inst}	[-]	1,0											
Diamantbohren	γ_{inst}	[-]	1,2				1,4							
Diamantbohren mit Aufrauen mit Aufrauwerkzeug Hilti TE-YRT	γ_{inst}	[-]	5)			1,0					5)			
Hammerbohren in wassergefüllten Bohrlöchern	γ_{inst}	[-]	1,4											
Betonausbruch														
Faktor für gerissen Beton	$k_{cr,N}$	[-]	7,7											
Faktor für ungerissenen Beton	$k_{ucr,N}$	[-]	11,0											
Randabstand	$c_{cr,N}$	[mm]	$1,5 \cdot h_{ef}$											
Achabstand	$s_{cr,N}$	[mm]	$3,0 \cdot h_{ef}$											
Spaltversagen														
Randabstand $c_{cr,sp}$ [mm] für	$h/h_{ef} \geq 2,0$		$1,0 \cdot h_{ef}$											
	$2,0 > h/h_{ef} > 1,3$		$4,6 \cdot h_{ef} - 1,8 \cdot h$											
	$h/h_{ef} \leq 1,3$		$2,26 \cdot h_{ef}$											
Achsabstand	$s_{cr,sp}$	[mm]	$2 \cdot c_{cr,sp}$											

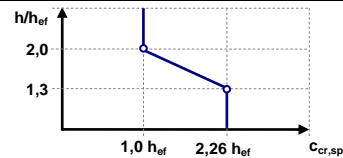

Injektionssystem Hilti HIT-RE 500 V4

Leistung
 Wesentliche Eigenschaften unter Zugbelastung in Beton

Anhang C16

Tabelle C6: Fortsetzung (1)

Bewehrungsstab (Rebar)	φ8	φ10	φ12	φ14	φ16	φ18	φ20	φ24	φ25	φ28	φ30	φ32	
Kombiniertes Herausziehen und Betonversagen für eine Lebensdauer von 50 Jahren													
Charakteristischer Widerstand in ungerissenem Beton C20/25 in Hammerbohrlöchern und Hammerbohrlöchern mit Hilti Hohlbohrer TE-CD oder TE-YD und Diamantbohrlöchern mit Aufrauung durch das Hilti Aufrauwerkzeug TE-YRT													
Temperaturbereich I: 24 °C / 40 °C	$\tau_{Rk,ucr}$	[N/mm ²]	10	15	15	15	14	14	14	14	14	13	13
Temperaturbereich II: 43 °C / 55 °C	$\tau_{Rk,ucr}$	[N/mm ²]	8,5	13	12	12	12	12	12	11	11	11	11
Temperaturbereich III: 55 °C / 75 °C	$\tau_{Rk,ucr}$	[N/mm ²]	3,5	5,0	5,0	5,0	4,5	4,5	4,5	4,5	4,5	4,5	4,5
Charakteristischer Widerstand in ungerissenem Beton C20/25 in Diamantbohrungen													
Temperaturbereich I: 24 °C / 40 °C	$\tau_{Rk,ucr}$	[N/mm ²]	9,5	9,5	9,5	9,5	9,5	9,5	9,5	9,5	10	10	10
Temperaturbereich II: 43 °C / 55 °C	$\tau_{Rk,ucr}$	[N/mm ²]	8,5	8,5	8,5	8,5	8,5	8,5	8,5	8,5	8,5	9,0	9,0
Temperaturbereich III: 55 °C / 75 °C	$\tau_{Rk,ucr}$	[N/mm ²]	4,0	4,0	4,0	4,0	4,0	4,0	4,5	4,5	4,5	4,5	4,5
Charakteristischer Widerstand in ungerissenem Beton C20/25 in Hammerbohrlöchern und Einbau in wassergefüllten Bohrlöchern													
Temperaturbereich I: 24 °C / 40 °C	$\tau_{Rk,ucr}$	[N/mm ²]	8,5	13	13	13	12	12	12	12	12	11	11
Temperaturbereich II: 43 °C / 55 °C	$\tau_{Rk,ucr}$	[N/mm ²]	7,0	11	11	10	10	10	10	10	9,5	9,5	9,5
Temperaturbereich III: 55 °C / 75 °C	$\tau_{Rk,ucr}$	[N/mm ²]	3,0	4,0	4,0	4,0	4,0	4,0	4,0	4,0	3,5	3,5	3,5
Charakteristischer Widerstand in gerissenem Beton C20/25 in Hammerbohrlöchern und Hammerbohrlöchern mit Hilti Hohlbohrer TE-CD oder TE-YD und Diamantbohrlöchern mit Aufrauung durch das Hilti Aufrauwerkzeug TE-YRT													
Temperaturbereich I: 24 °C / 40 °C	$\tau_{Rk,cr}$	[N/mm ²]	5,5	10	12	12	12	12	11	11	11	11	11
Temperaturbereich II: 43 °C / 55 °C	$\tau_{Rk,cr}$	[N/mm ²]	5,0	8,5	10	10	10	10	9,5	9,5	9,5	9,5	9,0
Temperaturbereich III: 55 °C / 75 °C	$\tau_{Rk,cr}$	[N/mm ²]	2,0	4,0	4,0	4,0	4,0	3,5	3,5	3,5	3,5	3,5	3,5
Einflussfaktoren ψ auf den Verbundtragfähigkeit τ_{Rk} in gerissenem und ungerissenem Beton													
Einfluss der Betonfestigkeit													
in Hammerbohrlöchern und Hammerbohrlöchern mit Hilti Hohlbohrer TE-CD oder TE-YD und Diamantbohrungen													
Temperaturbereich I bis III:	ψ_c	[-]	$(f_{ck}/20)^{0,1}$										
in Diamantbohrlöchern mit Aufrauung durch das Hilti Aufrauwerkzeug TE-YRT													
Temperaturbereich I bis III:	ψ_c	[-]	5)					1,0			5)		
Einfluss von Dauerbelastung													
in Hammerbohrlöchern und Hammerbohrlöchern mit Hilti Hohlbohrer TE-CD oder TE-YD und Diamantbohrlöchern mit Aufrauung durch das Hilti Aufrauwerkzeug TE-YRT													
Temperaturbereich I: 24 °C / 40 °C	ψ_{sus}^0	[-]	0,88										
Temperaturbereich II: 43 °C / 55 °C	ψ_{sus}^0	[-]	0,72										
Temperaturbereich III: 55 °C / 75 °C	ψ_{sus}^0	[-]	0,69										
in Diamantbohrungen													
Temperaturbereich I: 24 °C / 40 °C	ψ_{sus}^0	[-]	0,89										
Temperaturbereich II: 43 °C / 55 °C	ψ_{sus}^0	[-]	0,70										
Temperaturbereich III: 55 °C / 75 °C	ψ_{sus}^0	[-]	0,62										

Injektionssystem Hilti HIT-RE 500 V4

Leistung
 Wesentliche Eigenschaften unter Zugbelastung in Beton

Anhang C17

Tabelle C6: Fortsetzung (2)

Bewehrungsstab (Rebar)	φ8	φ10	φ12	φ14	φ16	φ18	φ20	φ24	φ25	φ28	φ30	φ32
Kombiniertes Herausziehen und Betonversagen für eine Lebensdauer von 100 Jahren												
Charakteristischer Widerstand in ungerissenem Beton C20/25 in Hammerbohrlöchern und Hammerbohrlöchern mit Hilti Hohlbohrer TE-CD oder TE-YD und Diamantbohrlöchern mit Aufrauung durch das Hilti Aufrauwerkzeug TE-YRT												
Temperaturbereich I: 24 °C / 40 °C	$\tau_{Rk,100,ucr}$ [N/mm ²]	10	15	15	15	15	14	14	14	14	13	13
Temperaturbereich II: 43 °C / 55 °C	$\tau_{Rk,100,ucr}$ [N/mm ²]	8,0	12	12	12	12	12	11	11	11	11	11
Temperaturbereich III: 55 °C / 75 °C	$\tau_{Rk,100,ucr}$ [N/mm ²]	3,0	5,0	5,0	5,0	4,5	4,5	4,5	4,5	4,5	4,5	4,5
Charakteristischer Widerstand in ungerissenem Beton C20/25 in Diamantbohrungen												
Temperaturbereich I: 24 °C / 40 °C	$\tau_{Rk,100,ucr}$ [N/mm ²]	9,5	9,5	9,5	9,5	9,5	9,5	9,5	9,5	10	10	10
Temperaturbereich II: 43 °C / 55 °C	$\tau_{Rk,100,ucr}$ [N/mm ²]	8,5	8,5	8,5	8,5	8,5	8,5	8,5	8,5	8,5	9,0	9,0
Temperaturbereich III: 55 °C / 75 °C	$\tau_{Rk,100,ucr}$ [N/mm ²]	4,0	4,0	4,0	4,0	4,0	4,0	4,5	4,5	4,5	4,5	4,5
Charakteristischer Widerstand in ungerissenem Beton C20/25 in Hammerbohrlöchern und Einbau in wassergefüllten Bohrlochern												
Temperaturbereich I: 24 °C / 40 °C	$\tau_{Rk,100,ucr}$ [N/mm ²]	8,5	13	13	13	12	12	12	12	12	11	11
Temperaturbereich II: 43 °C / 55 °C	$\tau_{Rk,100,ucr}$ [N/mm ²]	7,0	11	10	10	10	10	9,5	9,5	9,5	9,5	9,0
Temperaturbereich III: 55 °C / 75 °C	$\tau_{Rk,100,ucr}$ [N/mm ²]	2,5	4,0	4,0	4,0	4,0	4,0	4,0	4,0	3,5	3,5	3,5
Charakteristischer Widerstand in gerissenem Beton C20/25 in Hammerbohrlöchern und Hammerbohrlöchern mit Hilti Hohlbohrer TE-CD oder TE-YD und Diamantbohrlöchern mit Aufrauung durch das Hilti Aufrauwerkzeug TE-YRT												
Temperaturbereich I: 24 °C / 40 °C	$\tau_{Rk,100,cr}$ [N/mm ²]	5,0	9,0	10	10	9,5	9,5	9,5	9,0	9,0	9,0	9,0
Temperaturbereich II: 43 °C / 55 °C	$\tau_{Rk,100,cr}$ [N/mm ²]	4,5	8,0	9,0	9,0	8,5	8,5	8,5	8,0	8,0	8,0	8,0
Temperaturbereich III: 55 °C / 75 °C	$\tau_{Rk,100,cr}$ [N/mm ²]	2,0	4,0	4,0	4,0	4,0	4,0	3,5	3,5	3,5	3,5	3,5
Einflussfaktoren ψ auf den Verbundtragfähigkeit $\tau_{Rk,100}$ in gerissenem und ungerissenem Beton												
Einfluss der Betonfestigkeit												
in Hammerbohrlöchern und Hammerbohrlöchern mit Hilti Hohlbohrer TE-CD oder TE-YD und Diamantbohrungen												
Temperaturbereich I bis III:	ψ_c [-]	$(f_{ck}/20)^{0,1}$										
in Diamantbohrlöchern mit Aufrauung durch das Hilti Aufrauwerkzeug TE-YRT												
Temperaturbereich I bis III:	ψ_c [-]	5)					1,0			5)		
Einfluss von Dauerbelastung												
in Hammerbohrlöchern und Hammerbohrlöchern mit Hilti Hohlbohrer TE-CD oder TE-YD und Diamantbohrlöchern mit Aufrauung durch das Hilti Aufrauwerkzeug TE-YRT												
Temperaturbereich I: 24 °C / 40 °C	$\psi_{sus,100}^0$ [-]	0,85										
Temperaturbereich II: 43 °C / 55 °C	$\psi_{sus,100}^0$ [-]	0,72										
Temperaturbereich III: 55 °C / 75 °C	$\psi_{sus,100}^0$ [-]	0,69										
in Diamantbohrungen												
Temperaturbereich I: 24 °C / 40 °C	$\psi_{sus,100}^0$ [-]	0,70										
Temperaturbereich II: 43 °C / 55 °C	$\psi_{sus,100}^0$ [-]	0,67										
Temperaturbereich III: 55 °C / 75 °C	$\psi_{sus,100}^0$ [-]	0,62										

- 1) f_{uk} gemäß der Spezifikation für Bewehrungsstäbe.
- 2) Die Werte sind zu berechnen gem. EAD 330499-02, Gleichung. 2.1, wenn die Bewehrungsstäbe nicht die Anforderungen gem. DIN 488 erfüllen.
- 3) Die Werte sind zu berechnen gem. EN 1992-4:2018, Tab. 4.1, wenn die Bewehrungsstäbe nicht die Anforderungen gem. DIN 488 erfüllen.
- 4) Soweit es keine nationalen Vorschriften gibt.
- 5) Keine Leistung bewertet.

Injektionssystem Hilti HIT-RE 500 V4

Leistung
 Wesentliche Eigenschaften unter Zugbelastung in Beton

Anhang C18

Tabelle C7: Wesentliche Merkmale für metrische Gewindestangen gemäß Anhang A unter Querbelastung in Beton

Metrische Gewindestange gemäß Anhang A			M8	M10	M12	M16	M20	M24	M27	M30	
Für eine Nutzungsdauer von 50 und 100 Jahren											
Stahlversagen ohne Hebelarm											
Charakteristischer Widerstand	$V_{Rk,s}^0$	[kN]	$k_6 \cdot A_s \cdot f_{uk}$								
Faktor Festigkeitsklasse 5.8	k_6	[-]	0,6								
Faktor Festigkeitsklasse 6.8, 8.8	k_6	[-]	0,5								
Faktor HAS A4, HAS-U A4, HIT-V-R, Gewindestange: CRC II und III (Tabelle A2)	k_6	[-]	0,5								
Faktor HAS-U HCR, HIT-V-HCR, Gewindestange: CRC V (Tabelle A2)	k_6	[-]	0,5								
Teilsicherheitsbeiwert Festigkeitsklasse 5.8, 6.8, 8.8	$\gamma_{Ms,V}^{1)}$	[-]	1,25								
Teilsicherheitsbeiwert HAS A4, HAS-U A4, HIT-V-R, Gewindestange: CRC II und III (Tabelle A2)	$\gamma_{Ms,V}^{1)}$	[-]	1,56						2,38		
Teilsicherheitsbeiwert HAS-U HCR, HIT-V-HCR, Gewindestange: CRC V (Tabelle A2)	$\gamma_{Ms,V}^{1)}$	[-]	1,25				1,75				
Duktilitätsfaktor	k_7	[-]	1,0								
Stahlversagen mit Hebelarm											
Charakteristischer Widerstand	$M_{Rk,s}^0$	[Nm]	$1,2 \cdot W_{el} \cdot f_{uk}$								
Duktilitätsfaktor	k_7	[-]	1,0								
Betonausbruch auf der lastabgewandten Seite (pry-out)											
Pry-out Faktor	k_8	[-]	2,0								
Betonkantenbruch											
Effektive Länge des Befestigungselements	l_f	[mm]	$\min(h_{ef}; 12 \cdot d_{nom})$							$\min(h_{ef}; 8 \cdot d_{nom}; 300)$	
Außendurchmesser des Befestigungselements	d_{nom}	[mm]	8	10	12	16	20	24	27	30	

¹⁾ Soweit es keine nationalen Vorschriften gibt.

Injektionssystem Hilti HIT-RE 500 V4

Leistung
 Wesentliche Eigenschaften unter Querbelastung in Beton

Anhang C19

Tabelle C8: Wesentliche Merkmale für Zoll-Gewindestangen gemäß Anhang A unter Querbelastung in Beton

Zoll-Gewindestange gemäß Anhang A [in.]		3/8	1/2	5/8	3/4	7/8	1	1 1/4	
Für eine Nutzungsdauer von 50 und 100 Jahren									
Stahlversagen ohne Hebelarm									
Charakteristischer Widerstand	$V_{Rk,s}^0$	[kN]	$k_6 \cdot A_s \cdot f_{uk}$						
Faktor HIT-V	k_6	[-]	0,6						
Faktor HAS-E-36	k_6	[-]	0,6						
Faktor HAS-E-55	k_6	[-]	0,5						
Faktor HAS-B-105	k_6	[-]	0,5						
Faktor HAS-R 304	k_6	[-]	0,5						
Faktor HAS-E-316	k_6	[-]	0,5						
Teilsicherheitsbeiwert HIT-V	$\gamma_{Ms,V}^{1)}$	[-]	1,60						
Teilsicherheitsbeiwert HAS-E-36	$\gamma_{Ms,V}^{1)}$	[-]	1,61						
Teilsicherheitsbeiwert HAS-E-55	$\gamma_{Ms,V}^{1)}$	[-]	1,36						
Teilsicherheitsbeiwert HAS-B-105	$\gamma_{Ms,V}^{1)}$	[-]	1,50						
Teilsicherheitsbeiwert HAS-R 304	$\gamma_{Ms,V}^{1)}$	[-]	1,54			1,89		2,51	
Teilsicherheitsbeiwert HAS-R 316	$\gamma_{Ms,V}^{1)}$	[-]	1,54			1,89			
Duktilitätsfaktor	k_7	[-]	1,0						
Stahlversagen mit Hebelarm									
Charakteristischer Widerstand	$M_{Rk,s}^0$	[Nm]	$1,2 \cdot W_{el} \cdot f_{uk}$						
Duktilitätsfaktor	k_7	[-]	1,0						
Betonausbruch auf der lastabgewandten Seite (pry-out)									
Pry-out Faktor	k_8	[-]	2,0						
Betonkantenbruch									
Effektive Länge des Befestigungselements	l_f	[mm]	$\min(h_{ef}; 12 \cdot d_{nom})$					$\min(h_{ef}; 8 \cdot d_{nom}; 300)$	
Außendurchmesser des Befestigungselements	d_{nom}	[mm]	9,5	12,7	15,9	19,1	22,2	25,4	31,8

¹⁾ Soweit es keine nationalen Vorschriften gibt.

Injektionssystem Hilti HIT-RE 500 V4

Leistung
 Wesentliche Eigenschaften unter Querbelastung in Beton

Anhang C20

Tabelle C9: Wesentliche Merkmale für Innengewindehülsen HIS-(R)N unter Querbelastung in Beton

HIS-(R)N			M8	M10	M12	M16	M20
Für eine Nutzungsdauer von 50 und 100 Jahren							
Stahlversagen ohne Hebelarm							
Charakteristischer Widerstand	$V_{Rk,s}^0$	[kN]	13	23	34	63	58
Teilsicherheitsbeiwert	$\gamma_{Ms,V}^{1)}$	[-]	1,25				
Charakteristischer Widerstand HIS-RN mit Schraube Qualitätsstufe 70	$V_{Rk,s}^0$	[kN]	13	20	30	55	83
Teilsicherheitsbeiwert	$\gamma_{Ms,V}^{1)}$	[-]	1,56				
Duktilitätsfaktor	k_7	[-]	1,0				
Stahlversagen mit Hebelarm							
Charakteristischer Widerstand HIS-N	$M_{Rk,s}^0$	[Nm]	30	60	105	266	519
Charakteristischer Widerstand HIS-RN	$M_{Rk,s}^0$	[Nm]	26	52	92	233	454
Duktilitätsfaktor	k_7	[-]	1,0				
Betonausbruch auf der lastabgewandten Seite (pry-out)							
Pry-out Faktor	k_8	[-]	2,0				
Betonkantenbruch							
Effektive Länge des Befestigungselements	l_f	[mm]	90	110	125	170	205
Außendurchmesser des Befestigungselements	d_{nom}	[mm]	12,5	16,5	20,5	25,4	27,6

¹⁾ Soweit es keine nationalen Vorschriften gibt.

Injektionssystem Hilti HIT-RE 500 V4

Leistung
 Wesentliche Eigenschaften unter Querbelastung in Beton

Anhang C21

Tabelle C10: Wesentliche Merkmale für Innengewindehülsen HIS-(R)N unter Querbelastung in Beton

HIS-(R)N, Größe [in.]		3/8	1/2	5/8	3/4
Für eine Nutzungsdauer von 50 und 100 Jahren					
Stahlversagen ohne Hebelarm					
Charakteristischer Widerstand HIS-N Schraube gemäß SAE J429 Grade 5 oder ASTM A325 (1/2" bis 3/4")	$V_{Rk,s}^0$ [kN]	21	38	60	65
Teilsicherheitsbeiwert	$\gamma_{Ms,V}^{1)}$ [-]	1,50			1,25
Charakteristischer Widerstand HIS-N Schraube gemäß ASTM A193 Grade B7	$V_{Rk,s}^0$ [kN]	22	40	63	65
Teilsicherheitsbeiwert	$\gamma_{Ms,V}^{1)}$ [-]	1,50			1,25
Charakteristischer Widerstand HIS-RN Schraube gemäß ASTM A193 Grade B8M (AISI 316)	$V_{Rk,s}^0$ [kN]	19	35	55	93
Teilsicherheitsbeiwert	$\gamma_{Ms,V}^{1)}$ [-]	1,50			2,00
Charakteristischer Widerstand HIS-RN Schraube gemäß ASTM A193 Grade B8T (AISI 321)	$V_{Rk,s}^0$ [kN]	22	40	63	93
Teilsicherheitsbeiwert	$\gamma_{Ms,V}^{1)}$ [-]	1,50			2,00
Duktilitätsfaktor	k_7 [-]	1,0			
Stahlversagen mit Hebelarm					
Charakteristischer Widerstand HIS-N Schraube gemäß SAE J429 Grade 5 oder ASTM A325 (1/2" bis 3/4")	$M_{Rk,s}^0$ [Nm]	50	123	247	444
Charakteristischer Widerstand HIS-N Schraube gemäß ASTM A193 Grade B7	$M_{Rk,s}^0$ [Nm]	52	128	257	463
Charakteristischer Widerstand HIS-RN Schraube gemäß ASTM A193 Grade B8M (AISI 316)	$M_{Rk,s}^0$ [Nm]	45	113	226	407
Charakteristischer Widerstand HIS-RN Schraube gemäß ASTM A193 Grade B8T (AISI 321)	$M_{Rk,s}^0$ [Nm]	52	128	257	463
Duktilitätsfaktor	k_7 [-]	1,0			
Betonausbruch auf der lastabgewandten Seite (pry-out)					
Pry-out Faktor	k_8 [-]	2,0			
Betonkantenbruch					
Effektive Länge des Befestigungselements	l_f [mm]	110	125	170	205
Außendurchmesser des Befestigungselements	d_{nom} [mm]	16,5	20,5	25,4	27,6

¹⁾ Soweit es keine nationalen Vorschriften gibt.

Injektionssystem Hilti HIT-RE 500 V4

Leistung
 Wesentliche Eigenschaften unter Querbelastung in Beton

Anhang C22

Tabelle C11: Wesentliche Eigenschaften für Hilti Zuganker HZA / HZA-R unter Querbelastung in Beton

HZA / HZA-R		M12	M16	M20	M24	M27
Durchmesser des Betonstahls	ϕ [mm]	12	16	20	25	28
Für eine Nutzungsdauer von 50 und 100 Jahren						
Stahlversagen ohne Hebelarm						
Charakteristischer Widerstand HZA	$V_{Rk,S}^0$ [kN]	23	43	67	97	126
Charakteristischer Widerstand HZA-R	$V_{Rk,S}^0$ [kN]	31	55	86	124	²⁾
Teilsicherheitsbeiwert	$\gamma_{Ms,V}$ ¹⁾ [-]	1,5				
Duktilitätsfaktor	k_7 [-]	1,0				
Stahlversagen mit Hebelarm						
Charakteristischer Widerstand HZA	$M_{Rk,S}^0$ [Nm]	72	183	357	617	915
Charakteristischer Widerstand HZA-R	$M_{Rk,S}^0$ [Nm]	97	234	457	790	²⁾
Duktilitätsfaktor	k_7 [-]	1,0				
Betonausbruch auf der lastabgewandten Seite (pry-out)						
Pry-out Faktor	k_8 [-]	2,0				
Betonkantenbruch						
Effektive Länge des Befestigungselements	l_f [mm]	$\min(h_{ef}; 12 \cdot d_{nom})$			$\min(h_{ef}; 8 \cdot d_{nom}; 300)$	
Außendurchmesser des Befestigungselements	d_{nom} [mm]	12	16	20	24	27

¹⁾ Soweit es keine nationalen Vorschriften gibt.

²⁾ Keine Leistung bewertet.

Injektionssystem Hilti HIT-RE 500 V4

Leistung
 Wesentliche Eigenschaften unter Querbelastung in Beton

Anhang C22

Tabelle C12: Wesentliche Eigenschaften für Bewehrungsstäbe (Rebars) unter Querbelastung in Beton

Bewehrungsstab (Rebar)		φ8	φ10	φ12	φ14	φ16	φ18	φ20	φ24	φ25	φ28	φ30	φ32		
Für eine Nutzungsdauer von 50 und 100 Jahren															
Stahlversagen ohne Hebelarm															
Charakteristischer Widerstand	$V_{Rk,s}^0$	[kN]	$0,5 \cdot A_s \cdot f_{uk}^{1)}$												
Charakteristischer Widerstand Bewehrungsstab B500B nach DIN 488 ²⁾	$V_{Rk,s}^0$	[kN]	14	22	31	42	55	70	86	124	135	169	194	221	
Teilsicherheitsbeiwert Bewehrungsstahl B500B gemäß DIN 488 ³⁾	$\gamma_{Ms,V}^{4)}$	[-]	1,5												
Duktilitätsfaktor	k_7	[-]	1,0												
Stahlversagen mit Hebelarm															
Charakteristischer Widerstand	$M_{Rk,s}^0$	[Nm]	$1,2 \cdot W_{el} \cdot f_{uk}^{1)}$												
Charakteristischer Widerstand Bewehrungsstab B500B nach DIN 488	$M_{Rk,s}^0$	[Nm]	33	65	112	178	265	378	518	896	1012	1422	1749	2123	
Duktilitätsfaktor	k_7	[-]	1,0												
Betonausbruch auf der lastabgewandten Seite (pry-out)															
Pry-out Faktor	k_8	[-]	2,0												
Betonkantebruch															
Effektive Länge des Befestigungselements	l_f	[mm]	$\min(h_{ef}; 12 \cdot d_{nom})$							$\min(h_{ef}; 8 \cdot d_{nom}; 300)$					
Außendurchmesser des Befestigungselements	d_{nom}	[mm]	8	10	12	14	16	18	20	24	25	28	30	32	

- 1) f_{uk} gemäß der Spezifikation für Bewehrungsstäbe.
- 2) Die Werte sind zu berechnen gem. EAD 330499-02, Gleichung. 2.1, wenn die Bewehrungsstäbe nicht die Anforderungen gem. DIN 488 erfüllen.
- 3) Die Werte sind zu berechnen gem. EN 1992-4:2018, Tab. 4.1, wenn die Bewehrungsstäbe nicht die Anforderungen gem. DIN 488 erfüllen.
- 4) Soweit es keine nationalen Vorschriften gibt.

Injektionssystem Hilti HIT-RE 500 V4

Leistung
 Wesentliche Eigenschaften unter Querbelastung in Beton

Anhang C23

Tabelle C13: Verschiebungen für Gewindestangen unter Zugbelastung in Beton

Gewindestange, HAS-U-..., HIT-V-..., AM...8.8	M8	M10	M12	M16	M20	M24	M27	M30	
Gewindestange, HAS-..., HIT-V, Größe [in.]	-	3/8	1/2	5/8	3/4	7/8	1	1 1/4	
Verschiebung in ungerissenem Beton									
Temperaturbereich I: 24 °C / 40 °C	δ_{N0} [mm/(N/mm ²)]	0,04	0,05	0,05	0,06	0,06	0,07	0,08	0,08
	$\delta_{N\infty}$ [mm/(N/mm ²)]	0,10	0,11	0,12	0,13	0,15	0,17	0,18	0,19
Temperaturbereich II: 43 °C / 55 °C	δ_{N0} [mm/(N/mm ²)]	0,05	0,05	0,06	0,07	0,07	0,08	0,09	0,10
	$\delta_{N\infty}$ [mm/(N/mm ²)]	0,12	0,13	0,14	0,16	0,18	0,20	0,21	0,23
Temperaturbereich III: 55 °C / 75 °C	δ_{N0} [mm/(N/mm ²)]	0,05	0,06	0,06	0,07	0,08	0,09	0,09	0,10
	$\delta_{N\infty}$ [mm/(N/mm ²)]	0,12	0,13	0,15	0,17	0,19	0,21	0,23	0,24
Verschiebung in gerissenem Beton									
Temperaturbereich I: 24 °C / 40 °C	δ_{N0} [mm/(N/mm ²)]	0,02	0,03	0,05	0,08	0,10	0,13	0,15	0,18
	$\delta_{N\infty}$ [mm/(N/mm ²)]	0,12	0,19	0,14	0,19	0,16	0,16	0,15	0,18
Temperaturbereich II: 43 °C / 55 °C	δ_{N0} [mm/(N/mm ²)]	0,02	0,04	0,06	0,09	0,12	0,16	0,18	0,21
	$\delta_{N\infty}$ [mm/(N/mm ²)]	0,15	0,23	0,17	0,23	0,19	0,19	0,18	0,21
Temperaturbereich III: 55 °C / 75 °C	δ_{N0} [mm/(N/mm ²)]	0,02	0,04	0,06	0,10	0,13	0,17	0,19	0,22
	$\delta_{N\infty}$ [mm/(N/mm ²)]	0,16	0,24	0,18	0,24	0,20	0,20	0,19	0,22

Tabelle C14: Verschiebungen für HIS-(R)N mit Innengewinde unter Zugbelastung im Beton

HIS-(R)N	M8	M10	M12	M16	M20	
HIS-(R)N, Größe [in.]	-	3/8	1/2	5/8	3/4	
Verschiebung in ungerissenem Beton						
Temperaturbereich I: 24 °C / 40 °C	δ_{N0} [mm/(N/mm ²)]	0,05	0,06	0,06	0,07	0,08
	$\delta_{N\infty}$ [mm/(N/mm ²)]	0,12	0,13	0,15	0,17	0,18
Temperaturbereich II: 43 °C / 55 °C	δ_{N0} [mm/(N/mm ²)]	0,06	0,07	0,07	0,08	0,09
	$\delta_{N\infty}$ [mm/(N/mm ²)]	0,14	0,16	0,18	0,20	0,21
Temperaturbereich III: 55 °C / 75 °C	δ_{N0} [mm/(N/mm ²)]	0,06	0,07	0,07	0,09	0,10
	$\delta_{N\infty}$ [mm/(N/mm ²)]	0,15	0,16	0,19	0,21	0,22
Verschiebung in gerissenem Beton						
Temperaturbereich I: 24 °C / 40 °C	δ_{N0} [mm/(N/mm ²)]	0,02	0,03	0,05	0,08	0,10
	$\delta_{N\infty}$ [mm/(N/mm ²)]	0,12	0,19	0,14	0,19	0,16
Temperaturbereich II: 43 °C / 55 °C	δ_{N0} [mm/(N/mm ²)]	0,02	0,04	0,06	0,09	0,12
	$\delta_{N\infty}$ [mm/(N/mm ²)]	0,15	0,23	0,17	0,23	0,19
Temperaturbereich III: 55 °C / 75 °C	δ_{N0} [mm/(N/mm ²)]	0,02	0,04	0,06	0,10	0,13
	$\delta_{N\infty}$ [mm/(N/mm ²)]	0,16	0,24	0,18	0,24	0,20

Injektionssystem Hilti HIT-RE 500 V4

Leistung
 Verschiebungen unter Zugbelastung in Beton

Anhang C24

Tabelle C15: Verschiebungen für Hilti Zuganker HZA / HZA-R unter Zugbelastung in Beton

HZA / HZA-R		M12	M16	M20	M24	M27
Durchmesser des Betonstahls ϕ	[mm]	12	16	20	25	28
Verschiebung in ungerissenem Beton						
Temperaturbereich I: 24 °C / 40 °C	δ_{N0} [mm/(N/mm ²)]	0,05	0,06	0,07	0,07	0,08
	$\delta_{N\infty}$ [mm/(N/mm ²)]	0,12	0,15	0,17	0,18	0,19
Temperaturbereich II: 43 °C / 55 °C	δ_{N0} [mm/(N/mm ²)]	0,06	0,07	0,09	0,09	0,09
	$\delta_{N\infty}$ [mm/(N/mm ²)]	0,14	0,18	0,20	0,21	0,22
Temperaturbereich III: 55 °C / 75 °C	δ_{N0} [mm/(N/mm ²)]	0,07	0,08	0,09	0,09	0,10
	$\delta_{N\infty}$ [mm/(N/mm ²)]	0,15	0,19	0,22	0,22	0,23
Verschiebung in gerissenem Beton						
Temperaturbereich I: 24 °C / 40 °C	δ_{N0} [mm/(N/mm ²)]	0,06	0,10	0,14	0,15	0,16
	$\delta_{N\infty}$ [mm/(N/mm ²)]	0,06	0,16	0,16	0,15	0,16
Temperaturbereich II: 43 °C / 55 °C	δ_{N0} [mm/(N/mm ²)]	0,07	0,12	0,17	0,17	0,19
	$\delta_{N\infty}$ [mm/(N/mm ²)]	0,07	0,19	0,19	0,18	0,19
Temperaturbereich III: 55 °C / 75 °C	δ_{N0} [mm/(N/mm ²)]	0,08	0,13	0,17	0,18	0,20
	$\delta_{N\infty}$ [mm/(N/mm ²)]	0,08	0,20	0,20	0,19	0,20

Tabelle C16: Verschiebungen für Bewehrungsstäbe (Rebar) unter Zugbelastung in Beton

Bewehrungsstab (Rebar)		$\phi 8$	$\phi 10$	$\phi 12$	$\phi 14$	$\phi 16$	$\phi 18$
Verschiebung in ungerissenem Beton							
Temperaturbereich I: 24 °C / 40 °C	δ_{N0} [mm/(N/mm ²)]	0,04	0,05	0,05	0,06	0,06	0,07
	$\delta_{N\infty}$ [mm/(N/mm ²)]	0,10	0,11	0,12	0,13	0,15	0,16
Temperaturbereich II: 43 °C / 55 °C	δ_{N0} [mm/(N/mm ²)]	0,05	0,05	0,06	0,07	0,07	0,08
	$\delta_{N\infty}$ [mm/(N/mm ²)]	0,12	0,13	0,14	0,16	0,18	0,19
Temperaturbereich III: 55 °C / 75 °C	δ_{N0} [mm/(N/mm ²)]	0,05	0,06	0,07	0,07	0,08	0,08
	$\delta_{N\infty}$ [mm/(N/mm ²)]	0,12	0,13	0,15	0,17	0,19	0,21
Verschiebung in gerissenem Beton							
Temperaturbereich I: 24 °C / 40 °C	δ_{N0} [mm/(N/mm ²)]	0,02	0,03	0,06	0,08	0,10	0,11
	$\delta_{N\infty}$ [mm/(N/mm ²)]	0,12	0,19	0,06	0,19	0,16	0,16
Temperaturbereich II: 43 °C / 55 °C	δ_{N0} [mm/(N/mm ²)]	0,02	0,04	0,07	0,09	0,12	0,14
	$\delta_{N\infty}$ [mm/(N/mm ²)]	0,15	0,23	0,07	0,23	0,19	0,19
Temperaturbereich III: 55 °C / 75 °C	δ_{N0} [mm/(N/mm ²)]	0,02	0,04	0,08	0,10	0,13	0,14
	$\delta_{N\infty}$ [mm/(N/mm ²)]	0,16	0,24	0,08	0,24	0,20	0,20

Injektionssystem Hilti HIT-RE 500 V4

Leistung
 Verschiebungen unter Zugbelastung in Beton

Anhang C25

Tabelle C17: Verschiebungen für Bewehrungsstäbe (Rebar) unter Zugbelastung in Beton

Bewehrungsstab (Rebar)		φ20	φ24	φ25	φ28	φ30	φ32
Verschiebung in ungerissenem Beton							
Temperaturbereich I: 24 °C / 40 °C	δ_{N0} [mm/(N/mm ²)]	0,07	0,07	0,07	0,08	0,08	0,08
	$\delta_{N\infty}$ [mm/(N/mm ²)]	0,17	0,19	0,18	0,19	0,19	0,20
Temperaturbereich II: 43 °C / 55 °C	δ_{N0} [mm/(N/mm ²)]	0,09	0,08	0,09	0,09	0,10	0,10
	$\delta_{N\infty}$ [mm/(N/mm ²)]	0,20	0,21	0,21	0,22	0,23	0,24
Temperaturbereich III: 55 °C / 75 °C	δ_{N0} [mm/(N/mm ²)]	0,09	0,09	0,09	0,10	0,10	0,11
	$\delta_{N\infty}$ [mm/(N/mm ²)]	0,22	0,22	0,22	0,23	0,24	0,25
Verschiebung in gerissenem Beton							
Temperaturbereich I: 24 °C / 40 °C	δ_{N0} [mm/(N/mm ²)]	0,14	0,15	0,15	0,16	0,18	0,19
	$\delta_{N\infty}$ [mm/(N/mm ²)]	0,16	0,16	0,15	0,16	0,18	0,19
Temperaturbereich II: 43 °C / 55 °C	δ_{N0} [mm/(N/mm ²)]	0,17	0,17	0,17	0,19	0,21	0,22
	$\delta_{N\infty}$ [mm/(N/mm ²)]	0,19	0,19	0,18	0,19	0,21	0,22
Temperaturbereich III: 55 °C / 75 °C	δ_{N0} [mm/(N/mm ²)]	0,17	0,18	0,18	0,20	0,22	0,24
	$\delta_{N\infty}$ [mm/(N/mm ²)]	0,20	0,20	0,19	0,20	0,22	0,24

Injektionssystem Hilti HIT-RE 500 V4

Leistung
 Verschiebungen unter Zugbelastung in Beton

Anhang C26

Tabelle C18: Verschiebungen für Gewindestangen unter Querbelastung in Beton

Metrische Gewindestange gemäß Anhang A		M8	M10	M12	M16	M20	M24	M27	M30
Zoll-Gewindestange gemäß Anhang A [in.]		-	3/8	1/2	5/8	3/4	7/8	1	1 1/4
Verschiebung	δ_{V0} [mm/kN]	0,06	0,06	0,05	0,04	0,04	0,03	0,03	0,03
	$\delta_{V\infty}$ [mm/kN]	0,09	0,08	0,08	0,06	0,06	0,05	0,05	0,05

Tabelle C19: Verschiebungen für HIS-(R)N mit Innengewinde unter Querbelastung im Beton

HIS-(R)N		M8	M10	M12	M16	M20
HIS-(R)N, Größe [in.]		-	3/8	1/2	5/8	3/4
Verschiebung	δ_{V0} [mm/kN]	0,06	0,06	0,05	0,04	0,04
	$\delta_{V\infty}$ [mm/kN]	0,09	0,08	0,08	0,06	0,06

Tabelle C20: Verschiebungen für Hilti Zuganker HZA / HZA-R unter Querbelastung in Beton

HZA / HZA-R		M12	M16	M20	M24	M27
Verschiebung	δ_{V0} [mm/kN]	0,05	0,04	0,04	0,03	0,03
	$\delta_{V\infty}$ [mm/kN]	0,08	0,06	0,06	0,05	0,05

Tabelle C21: Verschiebungen für Bewehrungsstäbe (Rebar) unter Querbelastung in Beton

Bewehrungsstab (Rebar)		$\phi 10$	$\phi 12$	$\phi 14$	$\phi 16$	$\phi 18$	$\phi 20$
Verschiebung	δ_{V0} [mm/kN]	0,05	0,05	0,05	0,04	0,04	0,04
	$\delta_{V\infty}$ [mm/kN]	0,08	0,08	0,07	0,06	0,06	0,06

Tabelle C22: Verschiebungen für Bewehrungsstäbe (Rebar) unter Querbelastung in Beton

Bewehrungsstab (Rebar)		$\phi 24$	$\phi 25$	$\phi 28$	$\phi 30$	$\phi 32$	$\phi 24$
Verschiebung	δ_{V0} [mm/kN]	0,04	0,03	0,03	0,03	0,03	0,03
	$\delta_{V\infty}$ [mm/kN]	0,05	0,05	0,05	0,05	0,04	0,04

Injektionssystem Hilti HIT-RE 500 V4

Leistung
 Verschiebungen unter Querbelastung in Beton

Anhang C27

Tabelle C23: Wesentliche Merkmale für metrische Gewindestangen gemäß Anhang A unter Zugbelastung für die seismische Kategorie C1 in Beton

Metrische Gewindestange gemäß Anhang A	M8	M10	M12	M16	M20	M24	M27	M30		
Für eine Nutzungsdauer von 50 und 100 Jahren										
Stahlversagen										
Charakteristischer Widerstand	$N_{Rk,s,C1}$ [kN]			$A_s \cdot f_{uk}$						
Kombiniertes Herausziehen und Betonversagen für eine Lebensdauer von 50 Jahren										
Charakteristischer Widerstand in gerissenem Beton C20/25 in Hammerbohrlöchern und Hammerbohrlöchern mit Hilti Hohlbohrer TE-CD oder TE-YD und Diamantbohrlöchern mit Aufrauung durch das Hilti Aufrauwerkzeug TE-YRT										
Temperaturbereich I:	24 °C / 40 °C	$\tau_{Rk,C1}$ [N/mm ²]	6,8	8,2	10,1	10,5	9,7	9,4	9,0	8,5
Temperaturbereich II:	43 °C / 55 °C	$\tau_{Rk,C1}$ [N/mm ²]	6,3	7,3	8,3	8,1	7,8	7,9	7,5	7,0
Temperaturbereich III:	55 °C / 75 °C	$\tau_{Rk,C1}$ [N/mm ²]	3,6	3,2	3,2	3,3	2,9	3,0	3,0	3,0
Kombiniertes Herausziehen und Betonversagen für eine Lebensdauer von 100 Jahren										
Charakteristischer Widerstand in gerissenem Beton C20/25 in Hammerbohrlöchern und Hammerbohrlöchern mit Hilti Hohlbohrer TE-CD oder TE-YD und Diamantbohrlöchern mit Aufrauung durch das Hilti Aufrauwerkzeug TE-YRT										
Temperaturbereich I:	24 °C / 40 °C	$\tau_{Rk,100,C1}$ [N/mm ²]	6,3	7,3	8,3	8,1	7,8	7,4	7,0	6,5
Temperaturbereich II:	43 °C / 55 °C	$\tau_{Rk,100,C1}$ [N/mm ²]	5,4	6,4	7,4	7,1	6,8	6,4	6,5	6,0
Temperaturbereich III:	55 °C / 75 °C	$\tau_{Rk,100,C1}$ [N/mm ²]	3,6	3,2	3,2	3,3	2,9	3,0	3,0	3,0
Einflussfaktoren ψ auf den Verbundtragfähigkeit $\tau_{Rk,C1}$ und $\tau_{Rk,100,C1}$										
Einfluss der Betonfestigkeit										
Temperaturbereich I bis III:	ψ_c [-]		1,0							

Tabelle C24: Wesentliche Merkmale für Zoll-Gewindestangen gemäß Anhang A unter Zugbelastung für die seismische Kategorie C1 in Beton

Zoll-Gewindestange gemäß Anhang A	[in.]	3/8	1/2	5/8	3/4	7/8	1	1 1/4	
Für eine Nutzungsdauer von 50 und 100 Jahren									
Stahlversagen									
Charakteristischer Widerstand	$N_{Rk,s,C1}$ [kN]			$A_s \cdot f_{uk}$					
Kombiniertes Herausziehen und Betonversagen für eine Lebensdauer von 50 Jahren									
Charakteristischer Widerstand in gerissenem Beton C20/25 in Hammerbohrlöchern und Hammerbohrlöchern mit Hilti Hohlbohrer TE-CD oder TE-YD und Diamantbohrlöchern mit Aufrauung durch das Hilti Aufrauwerkzeug TE-YRT									
Temperaturbereich I:	24 °C / 40 °C	$\tau_{Rk,C1}$ [N/mm ²]	8,2	10,1	10,5	9,7	8,9	9,0	8,5
Temperaturbereich II:	43 °C / 55 °C	$\tau_{Rk,C1}$ [N/mm ²]	7,3	8,3	8,1	8,2	7,9	7,5	7,0
Temperaturbereich III:	55 °C / 75 °C	$\tau_{Rk,C1}$ [N/mm ²]	3,2	3,2	3,3	2,9	3,0	3,0	2,5
Kombiniertes Herausziehen und Betonversagen für eine Lebensdauer von 100 Jahren									
Charakteristischer Widerstand in gerissenem Beton C20/25 in Hammerbohrlöchern und Hammerbohrlöchern mit Hilti Hohlbohrer TE-CD oder TE-YD und Diamantbohrlöchern mit Aufrauung durch das Hilti Aufrauwerkzeug TE-YRT									
Temperaturbereich I:	24 °C / 40 °C	$\tau_{Rk,100,C1}$ [N/mm ²]	7,3	7,8	8,1	7,8	7,4	7,5	6,5
Temperaturbereich II:	43 °C / 55 °C	$\tau_{Rk,100,C1}$ [N/mm ²]	6,4	6,9	7,1	6,8	6,9	6,5	6,0
Temperaturbereich III:	55 °C / 75 °C	$\tau_{Rk,100,C1}$ [N/mm ²]	3,2	3,2	3,3	2,9	3,0	3,0	2,5
Einflussfaktoren ψ auf den Verbundtragfähigkeit $\tau_{Rk,C1}$ und $\tau_{Rk,100,C1}$									
Einfluss der Betonfestigkeit									
Temperaturbereich I bis III:	ψ_c [-]		1,0						

Injektionssystem Hilti HIT-RE 500 V4

Leistung

Wesentliche Merkmale für Zoll-Gewindestangen gemäß Anhang A unter Zugbelastung für die seismische Kategorie C1 in Beton

Anhang C28

Tabelle C25: Wesentliche Merkmale für Innengewindehülsen HIS-(R)N unter Zugbelastung für die seismische Kategorie C1 in Beton

HIS-(R)N	M8	M10	M12	M16	M20
Für eine Nutzungsdauer von 50 und 100 Jahren					
Stahlversagen					
Charakteristischer Widerstand HIS-N $N_{Rk,s,C1}$ [kN]	25	46	67	125	116
Charakteristischer Widerstand HIS-RN $N_{Rk,s,C1}$ [kN]	26	41	59	110	166
Kombiniertes Herausziehen und Betonversagen für eine Lebensdauer von 50 Jahren					
Charakteristischer Widerstand in gerissenem Beton C20/25 in Hammerbohrlöchern und Hammerbohrlöchern mit Hilti Hohlbohrer TE-CD oder TE-YD und Diamantbohrlöchern mit Aufrauung durch das Hilti Aufrauwerkzeug TE-YRT					
Temperaturbereich I: 24 °C / 40 °C $\tau_{Rk,C1}$ [N/mm ²]	8,4	8,6	8,7	9,0	9,0
Temperaturbereich II: 43 °C / 55 °C $\tau_{Rk,C1}$ [N/mm ²]	7,4	7,6	7,8	8,0	8,0
Temperaturbereich III: 55 °C / 75 °C $\tau_{Rk,C1}$ [N/mm ²]	2,8	3,3	3,4	3,5	3,5
Kombiniertes Herausziehen und Betonversagen für eine Lebensdauer von 100 Jahren					
Charakteristischer Widerstand in gerissenem Beton C20/25 in Hammerbohrlöchern und Hammerbohrlöchern mit Hilti Hohlbohrer TE-CD oder TE-YD und Diamantbohrlöchern mit Aufrauung durch das Hilti Aufrauwerkzeug TE-YRT					
Temperaturbereich I: 24 °C / 40 °C $\tau_{Rk,100,C1}$ [N/mm ²]	6,5	6,7	6,8	7,0	7,0
Temperaturbereich II: 43 °C / 55 °C $\tau_{Rk,100,C1}$ [N/mm ²]	5,6	6,2	6,3	6,5	6,5
Temperaturbereich III: 55 °C / 75 °C $\tau_{Rk,100,C1}$ [N/mm ²]	2,8	2,9	2,9	3,0	3,0
Einflussfaktoren ψ auf den Verbundtragfähigkeit $\tau_{Rk,C1}$ und $\tau_{Rk,100,C1}$					
Einfluss der Betonfestigkeit					
Temperaturbereich I bis III: ψ_c [-]	1,0				

Injektionssystem Hilti HIT-RE 500 V4

Leistung

Wesentliche Merkmale für Zoll-Gewindestangen gemäß Anhang A unter Zugbelastung für die seismische Kategorie C1 in Beton

Anhang C29

Tabelle C26: Wesentliche Merkmale für Gewindestangen unter Zugbelastung für die seismische Kategorie C1 in Beton

HIS-(R)N, Größe	[in.]	3/8	1/2	5/8	3/4	
Für eine Nutzungsdauer von 50 und 100 Jahren						
Stahlversagen						
Charakteristischer Widerstand HIS-N Schraube gemäß SAE J429 Grade 5 oder ASTM A325 (1/2" bis 3/4")	$N_{Rk,s,C1}$	[kN]	41	76	121	130
Charakteristischer Widerstand HIS-N Schraube gemäß ASTM A193 Grade B7	$N_{Rk,s,C1}$	[kN]	43	77	128	130
Charakteristischer Widerstand HIS-RN Schraube gemäß ASTM A193 Grade B8M (AISI 316)	$N_{Rk,s,C1}$	[kN]	38	110	182	185
Charakteristischer Widerstand HIS-RN Schraube gemäß ASTM A193 Grade B8T (AISI 321)	$N_{Rk,s,C1}$	[kN]	43	110	182	185
Kombiniertes Herausziehen und Betonversagen für eine Lebensdauer von 50 Jahren						
Charakteristischer Widerstand in gerissenem Beton C20/25 in Hammerbohrlöchern und Hammerbohrlöchern mit Hilti Hohlbohrer TE-CD oder TE-YD und Diamantbohrlöchern mit Aufrauung durch das Hilti Aufrauwerkzeug TE-YRT						
Temperaturbereich I: 24 °C / 40 °C	$\tau_{Rk,C1}$	[N/mm ²]	8,6	8,7	9,0	9,0
Temperaturbereich II: 43 °C / 55 °C	$\tau_{Rk,C1}$	[N/mm ²]	7,6	7,8	8,0	8,0
Temperaturbereich III: 55 °C / 75 °C	$\tau_{Rk,C1}$	[N/mm ²]	2,9	2,9	3,0	3,0
Kombiniertes Herausziehen und Betonversagen für eine Lebensdauer von 100 Jahren						
Charakteristischer Widerstand in gerissenem Beton C20/25 in Hammerbohrlöchern und Hammerbohrlöchern mit Hilti Hohlbohrer TE-CD oder TE-YD und Diamantbohrlöchern mit Aufrauung durch das Hilti Aufrauwerkzeug TE-YRT						
Temperaturbereich I: 24 °C / 40 °C	$\tau_{Rk,100,C1}$	[N/mm ²]	6,7	6,8	7,0	7,0
Temperaturbereich II: 43 °C / 55 °C	$\tau_{Rk,100,C1}$	[N/mm ²]	6,2	6,3	6,5	6,5
Temperaturbereich III: 55 °C / 75 °C	$\tau_{Rk,100,C1}$	[N/mm ²]	2,9	2,9	3,0	3,0
Einflussfaktoren ψ auf den Verbundtragfähigkeit $\tau_{Rk,C1}$ und $\tau_{Rk,100,C1}$						
Einfluss der Betonfestigkeit						
Temperaturbereich I bis III:	ψ_c	[-]	1,0			

Injektionssystem Hilti HIT-RE 500 V4

Leistung

Wesentliche Merkmale für Zoll-Gewindestangen gemäß Anhang A unter Zugbelastung für die seismische Kategorie C1 in Beton

Anhang C30

Tabelle C27: Wesentliche Eigenschaften für Hilti Zuganker HZA / HZA-R unter Zugbelastung für die seismische Kategorie C1 in Beton

HZA / HZA-R		M12	M16	M20	M24	M27
Durchmesser des Betonstahls	ϕ [mm]	12	16	20	25	28
Für eine Nutzungsdauer von 50 und 100 Jahren						
Stahlversagen						
Charakteristischer Widerstand HZA	$N_{Rk,s,C1}$ [kN]	46	86	135	194	253
Charakteristischer Widerstand HZA-R	$N_{Rk,s,C1}$ [kN]	62	111	173	248	1)
Kombiniertes Herausziehen und Betonversagen für eine Lebensdauer von 50 Jahren						
Charakteristischer Widerstand in gerissenem Beton C20/25 in Hammerbohrlöchern und Hammerbohrlöchern mit Hilti Hohlbohrer TE-CD oder TE-YD und Diamantbohrlöchern mit Aufrauung durch das Hilti Aufrauwerkzeug TE-YRT						
Temperaturbereich I:	24 °C / 40 °C $\tau_{Rk,C1}$ [N/mm ²]	11,0	11,4	11,6	10,9	11,0
Temperaturbereich II:	43 °C / 55 °C $\tau_{Rk,C1}$ [N/mm ²]	9,2	9,5	9,7	9,4	9,5
Temperaturbereich III:	55 °C / 75 °C $\tau_{Rk,C1}$ [N/mm ²]	3,7	3,8	3,4	3,5	3,5
Kombiniertes Herausziehen und Betonversagen für eine Lebensdauer von 100 Jahren						
Charakteristischer Widerstand in gerissenem Beton C20/25 in Hammerbohrlöchern und Hammerbohrlöchern mit Hilti Hohlbohrer TE-CD oder TE-YD und Diamantbohrlöchern mit Aufrauung durch das Hilti Aufrauwerkzeug TE-YRT						
Temperaturbereich I:	24 °C / 40 °C $\tau_{Rk,100,C1}$ [N/mm ²]	9,2	9,0	9,2	8,9	9,0
Temperaturbereich II:	43 °C / 55 °C $\tau_{Rk,100,C1}$ [N/mm ²]	8,3	8,1	8,2	7,9	8,0
Temperaturbereich III:	55 °C / 75 °C $\tau_{Rk,100,C1}$ [N/mm ²]	3,7	3,8	3,4	3,5	3,5
Einflussfaktoren ψ auf den Verbundtragfähigkeit $\tau_{Rk,C1}$ und $\tau_{Rk,100,C1}$						
Einfluss der Betonfestigkeit						
Temperaturbereich I bis III:	ψ_c [-]	1,0				

1) Keine Leistung bewertet.

Injektionssystem Hilti HIT-RE 500 V4

Leistung

Wesentliche Merkmale für Zoll-Gewindestangen gemäß Anhang A unter Zugbelastung für die seismische Kategorie C1 in Beton

Anhang C31

Tabelle C28: Wesentliche Eigenschaften für Bewehrungsstäbe (Rebars) unter Zugbelastung für die seismische Kategorie C1 in Beton

Bewehrungsstab (Rebar)	$\phi 10$	$\phi 12$	$\phi 14$	$\phi 16$	$\phi 18$	$\phi 20$	$\phi 24$	$\phi 25$	$\phi 28$	$\phi 30$	$\phi 32$
Für eine Nutzungsdauer von 50 und 100 Jahren											
Stahlversagen											
Charakteristischer Widerstand $N_{Rk,s,C1}$ [kN]	$A_s \cdot f_{uk}^{1)}$										
Charakteristischer Widerstand Rebar B500B gemäß DIN 488 ²⁾ $N_{Rk,s,C1}$ [kN]	43	62	85	111	140	173	249	270	339	389	442
Kombiniertes Herausziehen und Betonversagen für eine Lebensdauer von 50 Jahren											
Charakteristischer Widerstand in gerissenem Beton C20/25 in Hammerbohrlöchern und Hammerbohrlöchern mit Hilti Hohlbohrer TE-CD oder TE-YD und Diamantbohrlöchern mit Aufrauung durch das Hilti Aufrauwerkzeug TE-YRT											
Temperaturbereich I: 24 °C / 40 °C $\tau_{Rk,C1}$ [N/mm ²]	9,1	11,0	11,0	11,4	11,5	11,6	10,8	10,9	11,0	11,0	11,0
Temperaturbereich II: 43 °C / 55 °C $\tau_{Rk,C1}$ [N/mm ²]	7,7	9,2	9,2	9,5	9,6	9,7	9,3	9,4	9,5	9,5	9,0
Temperaturbereich III: 55 °C / 75 °C $\tau_{Rk,C1}$ [N/mm ²]	3,6	3,7	3,7	3,8	3,8	3,4	3,4	3,5	3,5	3,5	3,5
Kombiniertes Herausziehen und Betonversagen für eine Lebensdauer von 100 Jahren											
Charakteristischer Widerstand in gerissenem Beton C20/25 in Hammerbohrlöchern und Hammerbohrlöchern mit Hilti Hohlbohrer TE-CD oder TE-YD und Diamantbohrlöchern mit Aufrauung durch das Hilti Aufrauwerkzeug TE-YRT											
Temperaturbereich I: 24 °C / 40 °C $\tau_{Rk,100,C1}$ [N/mm ²]	8,2	9,2	9,2	9,0	9,1	9,2	8,8	8,9	9,0	9,0	9,0
Temperaturbereich II: 43 °C / 55 °C $\tau_{Rk,100,C1}$ [N/mm ²]	7,3	8,3	8,3	8,1	8,2	8,2	7,8	7,9	8,0	8,0	8,0
Temperaturbereich III: 55 °C / 75 °C $\tau_{Rk,100,C1}$ [N/mm ²]	3,6	3,7	3,7	3,8	3,8	3,4	3,4	3,5	3,5	3,5	3,5
Einflussfaktoren ψ auf den Verbundtragfähigkeit $\tau_{Rk,C1}$ und $\tau_{Rk,100,C1}$											
Einfluss der Betonfestigkeit											
Temperaturbereich I bis III: ψ_c [-]	1,0										

¹⁾ f_{uk} gemäß der Spezifikation für Bewehrungsstäbe.

²⁾ Die Werte sind zu berechnen gem. EAD 330499-02, Gleichung 2.1, wenn die Bewehrungsstäbe nicht die Anforderungen gem. DIN 488 erfüllen.

Injektionssystem Hilti HIT-RE 500 V4

Leistung

Wesentliche Merkmale für Zoll-Gewindestangen gemäß Anhang A unter Zugbelastung für die seismische Kategorie C1 in Beton

Anhang C32

Tabelle C29: Wesentliche Merkmale für metrische Gewindestangen gemäß Anhang A unter Querbelastung für die seismische Kategorie C1 in Beton

Gewindestange, HAS-U-..., HIT-V-..., AM...8.8	M8	M10	M12	M16	M20	M24	M27	M30
Für eine Nutzungsdauer von 50 und 100 Jahren								
Ringspaltfaktor ohne Hilti Verfüll-Set α_{gap} [-]	0,5							
Ringspaltfaktor mit Hilti Verfüll-Set α_{gap} [-]	1,0						1)	
Stahlversagen ohne Hebelarm								
Charakteristischer Widerstand HAS 5.8, HAS-U-5.8, HIT-V-5.8 $V_{Rk,s,C1}$ [kN]	0,6 · A_s · f_{uk}							
Charakteristischer Widerstand HAS 8.8, HAS-U-8.8., HIT-V-8.8, AM...8.8 $V_{Rk,s,C1}$ [kN]	0,5 · A_s · f_{uk}							
Charakteristischer Widerstand Handelsübliche Standard-Gewindestange $V_{Rk,s,C1}$ [kN]	0,35 · A_s · f_{uk}							

1) Keine Leistung bewertet.

Tabelle C30: Wesentliche Merkmale für Zoll-Gewindestangen gemäß Anhang A unter Querbelastung für die seismische Kategorie C1 in Beton

Gewindestange, HAS-..., HIT-V, Größe [in.]	3/8	1/2	5/8	3/4	7/8	1	1 1/4
Für eine Nutzungsdauer von 50 und 100 Jahren							
Ringspaltfaktor ohne Hilti Verfüll-Set α_{gap} [-]	0,5						
Stahlversagen ohne Hebelarm							
Charakteristischer Widerstand HAS-..., HIT-V $V_{Rk,s,C1}$ [kN]	0,5 · A_s · f_{uk}						
Charakteristischer Widerstand Handelsübliche Standard-Gewindestange $V_{Rk,s,C1}$ [kN]	0,35 · A_s · f_{uk}						

Tabelle C31: Wesentliche Merkmale für Innengewindehülsen HIS-(R)N unter Querbelastung für die seismische Kategorie C1 in Beton

HIS-(R)N	M8	M10	M12	M16	M20
Für eine Nutzungsdauer von 50 und 100 Jahren					
Ringspaltfaktor ohne Hilti Verfüll-Set α_{gap} [-]	0,5				
Ringspaltfaktor mit Hilti Verfüll-Set α_{gap} [-]	1,0				
Stahlversagen ohne Hebelarm					
Charakteristischer Widerstand HIS-N mit Schraube Festigkeitsklasse 8.8 $V_{Rk,s,C1}$ [kN]	9,0	16	27	41	39
Charakteristischer Widerstand HIS-RN mit Schraube Klasse 70 $V_{Rk,s,C1}$ [kN]	9,0	14	21	39	58

Injektionssystem Hilti HIT-RE 500 V4

Leistung

Wesentliche Merkmale für Zoll-Gewindestangen gemäß Anhang A unter Querbelastung für die seismische Kategorie C1 in Beton

Anhang C33

Tabelle C32: Wesentliche Merkmale für Innengewindehülsen HIS-(R)N unter Querbelastung für die seismische Kategorie C1 in Beton

HIS-(R)N, Größe	[in.]	3/8	1/2	5/8	3/4	
Für eine Nutzungsdauer von 50 und 100 Jahren						
Ringspaltfaktor ohne Hilti Verfüll- Set	α_{gap}	[-]				0,5
Stahlversagen ohne Hebelarm						
Charakteristischer Widerstand HIS-N Schraube gemäß SAE J429 Grade 5 oder ASTM A325 (1/2" bis 3/4")	$V_{Rk,s,C1}$	[kN]	14	27	42	45
Charakteristischer Widerstand HIS-N Schraube gemäß ASTM A193 Grade B7	$V_{Rk,s,C1}$	[kN]	15	28	44	45
Charakteristischer Widerstand HIS-RN Schraube gemäß ASTM A193 Grade B8M (AISI 316)	$V_{Rk,s,C1}$	[kN]	13	24	39	65
Charakteristischer Widerstand HIS-RN Schraube gemäß ASTM A193 Grade B8T (AISI 321)	$V_{Rk,s,C1}$	[kN]	15	28	44	65

Tabelle C33: Wesentliche Eigenschaften für Hilti Zuganker HZA / HZA-R unter Querbelastung für die seismische Kategorie C1 in Beton

HZA / HZA-R	M12	M16	M20	M24	M27		
Für eine Nutzungsdauer von 50 und 100 Jahren							
Ringspaltfaktor ohne Hilti Verfüll-Set	α_{gap}					[-]	0,5
Stahlversagen ohne Hebelarm							
Charakteristischer Widerstand HZA	$V_{Rk,s,C1}$	[kN]	23	43	67	97	126
Charakteristischer Widerstand HZA-R	$V_{Rk,s,C1}$	[kN]	31	55	86	124	¹⁾

¹⁾ Keine Leistung bewertet.

Tabelle C34: Wesentliche Eigenschaften für Bewehrungsstäbe (Rebars) unter Querbelastung für die seismische Kategorie C1 in Beton

Bewehrungsstab (Rebar)	$\phi 10$	$\phi 12$	$\phi 14$	$\phi 16$	$\phi 18$	$\phi 20$	$\phi 24$	$\phi 25$	$\phi 28$	$\phi 30$	$\phi 32$		
Für eine Nutzungsdauer von 50 und 100 Jahren													
Stahlversagen ohne Hebelarm													
Charakteristischer Widerstand	$V_{Rk,s,C1}$	[kN]	$0,35 \cdot A_s \cdot f_{uk}$ ¹⁾										
Charakteristischer Widerstand Bewehrungsstab B500B nach DIN 488 ²⁾	$V_{Rk,s,C1}$	[kN]	15	22	30	39	49	60	87	95	118	136	155

¹⁾ f_{uk} gemäß der Spezifikation für Bewehrungsstäbe.

²⁾ Die Werte sind zu berechnen gem. EAD 330499-02, Gleichung 2.1, wenn die Bewehrungsstäbe nicht die Anforderungen gem. DIN 488 erfüllen.

Injektionssystem Hilti HIT-RE 500 V4

Leistung

Wesentliche Merkmale für Zoll-Gewindestangen gemäß Anhang A unter Querbelastung für die seismische Kategorie C1 in Beton

Anhang C34

Tabelle C35: Wesentliche Merkmale für metrische Gewindestangen gemäß Anhang A unter Zugbelastung für die seismische Kategorie C2 in Beton

Metrische Gewindestange gemäß Anhang A	M12	M16	M20	M24	M27	M30
Für eine Nutzungsdauer von 50 und 100 Jahren						
Stahlversagen						
Charakteristischer Widerstand HAS (8.8, 8.8 HDG, A4), HAS-U (8.8, 8.8 HDG, A4, HCR), HIT-V (-8.8, -8.8F, -R, -HCR), AM (8.8, 8.8 HDG), Gewindestange (galvanisch verzinkt 8.8, CRC II, CRC III und CRC V, siehe Tabelle A1)	$N_{Rk,s,C2}$ [kN]		$A_s \cdot f_{uk}$			
Kombiniertes Herausziehen und Betonversagen für eine Lebensdauer von 50 Jahren						
Charakteristischer Widerstand in gerissenem Beton C20/25 in Hammerbohrlöchern und Hammerbohrlöchern mit Hilti Hohlbohrer TE-CD oder TE-YD						
Temperaturbereich I: 24 °C / 40 °C	$\tau_{Rk,C2}$ [N/mm ²]	3,7	6,5	5,8	6,0	5,0
Temperaturbereich II: 43 °C / 55 °C	$\tau_{Rk,C2}$ [N/mm ²]	3,1	5,3	4,8	5,0	4,2
Temperaturbereich III: 55 °C / 75 °C	$\tau_{Rk,C2}$ [N/mm ²]	1,2	2,1	1,9	1,9	1,6
Kombiniertes Herausziehen und Betonversagen für eine Lebensdauer von 100 Jahren						
Charakteristischer Widerstand in gerissenem Beton C20/25 in Hammerbohrlöchern und Hammerbohrlöchern mit Hilti Hohlbohrer TE-CD oder TE-YD						
Temperaturbereich I: 24 °C / 40 °C	$\tau_{Rk,100,C2}$ [N/mm ²]	3,7	6,5	5,8	6,0	5,0
Temperaturbereich II: 43 °C / 55 °C	$\tau_{Rk,100,C2}$ [N/mm ²]	3,0	5,3	4,8	4,9	4,1
Temperaturbereich III: 55 °C / 75 °C	$\tau_{Rk,100,C2}$ [N/mm ²]	1,2	2,1	1,9	1,9	1,6
Einflussfaktor ψ auf den Verbundtragfähigkeit $\tau_{Rk,C2}$ und $\tau_{Rk,100,C2}$						
Einfluss der Betonfestigkeit						
Temperaturbereich I bis III:	ψ_c [-]	1,0				

Injektionssystem Hilti HIT-RE 500 V4

Leistung

Wesentliche Merkmale für Zoll-Gewindestangen gemäß Anhang A unter Zugbelastung für die seismische Kategorie C2 in Beton

Anhang C35

Tabelle C36: Wesentliche Merkmale für metrische Gewindestangen gemäß Anhang A unter Querbelastung für die seismische Kategorie C2 in Beton

Metrische Gewindestange gemäß Anhang A	M12	M16	M20	M24	M27	M30
Für eine Nutzungsdauer von 50 und 100 Jahren						
Ringspaltfaktor ohne Hilti Verfüll-Set α_{gap} [-]	0,5					
Ringspaltfaktor mit Hilti Verfüll-Set α_{gap} [-]	1,0				1)	
Stahlversagen ohne Hebelarm mit Hilti Verfüll-Set						
Charakteristischer Widerstand HAS 8.8, HAS-U 8.8, HIT-V-8.8, AM 8.8 $V_{Rk,s,C2}$ [kN]	28	46	77	103	1)	
Stahlversagen ohne Hebelarm ohne Hilti Verfüll-Set						
Charakteristischer Widerstand HAS 8.8, HAS-U 8.8, HIT-V-8.8, AM 8.8 $V_{Rk,s,C2}$ [kN]	24	40	71	90	121	135
Charakteristischer Widerstand HAS 8.8, HAS-U 8.8 HDG, HIT-V-8.8F, AM HDG 8.8 $V_{Rk,s,C2}$ [kN]	18	30	46	66	1)	
Charakteristischer Widerstand HAS A4, HAS-U A4, HIT-V-R $V_{Rk,s,C2}$ [kN]	21	35	62	79	76	84
Charakteristischer Widerstand HAS-U HCR, HIT-V-HCR $V_{Rk,s,C2}$ [kN]	24	40	71	79	106	118
Charakteristischer Widerstand Handelsübliche Standard-Gewindestange 8.8 $V_{Rk,s,C2}$ [kN]	17	28	50	63	85	95
Charakteristischer Widerstand Handelsübliche Standard-Gewindestange A4 $V_{Rk,s,C2}$ [kN]	15	25	43	55	53	59
Charakteristischer Widerstand Handelsübliche Standard-Gewindestange HCR $V_{Rk,s,C2}$ [kN]	17	28	50	55	74	83

1) Keine Leistung bewertet.

Injektionssystem Hilti HIT-RE 500 V4

Leistung

Wesentliche Merkmale für Zoll-Gewindestangen gemäß Anhang A unter Querbelastung für die seismische Kategorie C2 in Beton

Anhang C36

Tabelle C37: Verschiebungen für metrische Gewindestangen gemäß Anhang A unter Zugbelastung für die seismische Kategorie C2 in Beton

Metrische Gewindestange gemäß Anhang A		M12	M16	M20	M24	M27	M30
Gewindestange, HAS 8.8, HAS-U-..., HIT-V-..., AM...8.8	$\delta_{N,C2(DLS)}$ [mm]	0,2	0,5	0,5	0,4	0,4	0,5
	$\delta_{N,C2(ULS)}$ [mm]	0,6	1,2	0,9	0,8	1,0	0,9

Tabelle C38: Verschiebungen für metrische Gewindestangen gemäß Anhang A unter Querbelastung für die seismische Kategorie C2 in Beton

Metrische Gewindestange gemäß Anhang A		M12	M16	M20	M24	M27	M30
Einbau mit Hilti Verfüll-Set							
HAS 8.8, HAS-U 8.8, HIT-V 8.8, AM 8.8	$\delta_{V,C2(DLS)}$ [mm]	0,6	1,2	1,4	1,1	1)	
	$\delta_{V,C2(ULS)}$ [mm]	3,1	3,2	3,7	2,6	1)	
Einbau ohne Hilti Verfüll-Set							
Gewindestange, HAS..., HAS-U..., HIT-V-..., AM 8.8	$\delta_{V,C2(DLS)}$ [mm]	1,9	3,2	2,5	3,5	3,0	1,9
	$\delta_{V,C2(ULS)}$ [mm]	4,4	9,2	7,1	10,2	7,2	6,3
HAS 8.8 HDG, HAS-U 8.8 HDG, HIT-V-F 8.8, AM HDG 8.8	$\delta_{V,C2(DLS)}$ [mm]	2,2	2,3	3,8	3,4	1)	
	$\delta_{V,C2(ULS)}$ [mm]	4,1	4,3	9,1	8,4	1)	

1) Keine Leistung bewertet.

Injektionssystem Hilti HIT-RE 500 V4

Leistung
 Verschiebungen für die seismische Leistungsklasse C2 in Beton

Anhang C37

Charakteristische Verbundtragfähigkeit eines einzelnen Verbundankers $\tau_{Rk,fi,p}(\theta)$ für die Betonfestigkeitsklassen C20/25 bis C50/60 mit allen Bohrverfahren unter Brandbedingungen²

Die charakteristische Verbundtragfähigkeit eines einzelnen Verbundankers unter Brandbedingungen $\tau_{Rk,fi,p}$ bei einer gegebenen Temperatur (θ) wird anhand der folgenden Gleichungen berechnet:

$$\tau_{Rk,fi,p}(\theta) = k_{fi,p}(\theta) \cdot \tau_{Rk,cr,C20/25}$$

wobei: $\theta \leq \theta_{max}$: $k_{fi,p}(\theta) = k_{fi,p,100y}(\theta) = 39,83 \cdot \theta^{-1,266} \leq 1,0$

und $\theta < \theta_{max}$: $k_{fi,p}(\theta) = k_{fi,p,100y}(\theta) = 0,0$

$\theta_{max} = 305 \text{ °C}$

$\tau_{Rk,fi,p}$ = charakteristische Verbundtragfähigkeit für gerissenen Beton unter Brandeinwirkung für eine gegebene Temperatur (θ)

$k_{fi,p}(\theta)$ = Reduktionsfaktor für die Verbundtragfähigkeit unter Brandeinwirkung

$\tau_{Rk,cr,C20/25}$ = charakteristischer Verbundtragfähigkeit für rissigen Beton für die Betonfestigkeitsklasse C20/25 für den relevanten Temperaturbereich

Abbildung C5: Reduktionsfaktor $k_{fi,p}(\theta)$

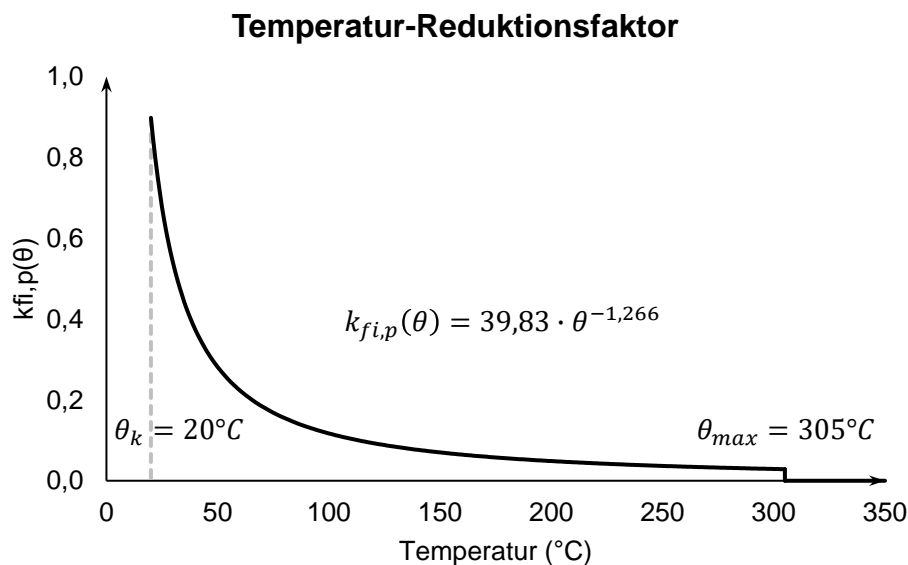

² Siehe Anhang B1 für den charakteristischen Widerstand eines Befestigungselements, einer Gruppe von Befestigungselementen und das gespannten Befestigungselement einer Gruppe von Befestigungselementen bei kombiniertem Ausreißen und Betonversagen unter Brandbedingungen $N_{Rk,p,fi}$

Injektionssystem Hilti HIT-RE 500 V4

Leistung

Abminderungsfaktor für Herausziehen einzelner Befestigungsmittel unter Brandeinwirkung

Anhang C38

Tabelle C39: Charakteristischer Widerstand unter Zugbelastung bei Stahlversagen unter Brandbedingungen

Größe des Verbindungselements		M8	M10	M12	M16	M20	M24	M27	M30
HAS 5.8, 5.8 HDG	$N_{Rk,s,fi(30)}$ [kN]	1,04	1,77	2,76	5,15	8,04	11,58	15,05	18,40
HAS 8.8, 8.8 HDG	$N_{Rk,s,fi(60)}$ [kN]	0,81	1,34	2,03	3,79	5,91	8,51	11,07	13,53
HAS-U 5.8, 5.8 HDG	$N_{Rk,s,fi(90)}$ [kN]	0,59	0,91	1,30	2,42	3,78	5,45	7,09	8,66
HAS-U 8.8, 8.8 HDG	$N_{Rk,s,fi(120)}$ [kN]	0,47	0,70	0,94	1,74	2,72	3,92	5,09	6,22
HAS A4 HAS-U A4-70 HAS-U HCR	$N_{Rk,s,fi(30)}$ [kN]	2,67	4,85	7,94	14,78	23,06	33,23	43,21	52,81
	$N_{Rk,s,fi(60)}$ [kN]	1,93	3,44	5,57	10,37	16,18	23,32	30,32	37,06
	$N_{Rk,s,fi(90)}$ [kN]	1,18	2,03	3,20	5,96	9,30	13,40	17,43	21,30
	$N_{Rk,s,fi(120)}$ [kN]	0,80	1,33	2,02	3,76	5,86	8,44	10,98	13,42

Tabelle C40: Charakteristischer Widerstand unter Zugbelastung bei Stahlversagen unter Brandbedingungen

Größe des Verbindungselements		[in.]	3/8	1/2	5/8	3/4	7/8	1	1 1/4
HAS-E-55 HAS-B-105 (HDG)	$N_{Rk,s,fi(30)}$ [kN]		1,50	3,00	4,78	7,08	9,77	12,82	20,50
	$N_{Rk,s,fi(60)}$ [kN]		1,15	2,21	3,52	5,20	7,18	9,42	15,08
	$N_{Rk,s,fi(90)}$ [kN]		0,79	1,41	2,25	3,33	4,60	6,03	9,65
	$N_{Rk,s,fi(120)}$ [kN]		0,61	1,02	1,62	2,39	3,31	4,34	6,94

Tabelle C41: Charakteristischer Widerstand unter Zuglast bei Betonausbruch- und Spaltversagen unter Brandbedingungen

Größe des Verbindungselements		M8, M10, M12, M16, M20, M24, M27, M30 [in.] 3/8, 1/2, 5/8, 3/4, 7/8, 1, 1 1/4
HAS 5.8, 5.8 HDG HAS 8.8, 8.8 HDG HAS-U 5.8, 5.8 HDG HAS-U 8.8, 8.8 HDG HIT-V 5.8, 5.8F HIT-V 8.8, 8.8F	$N_{Rk,c,fi(30)}^0$ [kN]	$\frac{h_{ef}}{200} \cdot N_{Rk,c}^0 \leq N_{Rk,c}^0$
	$N_{Rk,c,fi(60)}^0$ [kN]	
	$N_{Rk,c,fi(90)}^0$ [kN]	
	$N_{Rk,c,fi(120)}^0$ [kN]	
HAS-E-55 HAS-B-105 (HDG) HAS A4 HAS-U A4-70 HAS-U HCR	$N_{Rk,c,fi(120)}^0$ [kN]	$0,8 \cdot \frac{h_{ef}}{200} \cdot N_{Rk,c}^0 \leq N_{Rk,c}^0$
Charakteristischer Achsabstand	$s_{cr,N,fi}$ [mm]	$4h_{ef}$
Charakteristischer Randabstand	$c_{cr,N,fi}$ [mm]	$2h_{ef}$

Injektionssystem Hilti HIT-RE 500 V4

Leistung

Charakteristischer Widerstand unter Zuglast bei Stahl- und Betonkonusversagen unter Brandbedingungen

Anhang C39

Tabelle C42: Charakteristischer Widerstand unter Querlast bei Stahlversagen unter Brandbedingungen

Größe des Verbindungselements		M8	M10	M12	M16	M20	M24	M27	M30
HAS 5.8, 5.8 HDG HAS 8.8, 8.8 HDG HAS-U 5.8, 5.8 HDG HAS-U 8.8, 8.8 HDG HIT-V 5.8, 5.8F HIT-V 8.8, 8.8F	$V_{Rk,s,fi(30)}$ [kN]	1,04	1,77	2,76	5,15	8,04	11,58	15,05	18,40
	$V_{Rk,s,fi(60)}$ [kN]	0,81	1,34	2,03	3,79	5,91	8,51	11,07	13,53
	$V_{Rk,s,fi(90)}$ [kN]	0,59	0,91	1,30	2,42	3,78	5,45	7,09	8,66
	$V_{Rk,s,fi(120)}$ [kN]	0,47	0,70	0,94	1,74	2,72	3,92	5,09	6,22
	$M_{Rk,s,fi(30)}^0$ [Nm]	1,06	2,28	4,29	10,92	21,28	36,81	54,58	73,76
	$M_{Rk,s,fi(60)}^0$ [Nm]	0,83	1,73	3,15	8,02	15,65	27,07	40,14	54,23
	$M_{Rk,s,fi(90)}^0$ [Nm]	0,60	1,17	2,02	5,13	10,01	17,32	25,69	34,71
	$M_{Rk,s,fi(120)}^0$ [Nm]	0,48	0,89	1,45	3,69	7,20	12,45	18,46	24,95
HAS A4 HAS-U A4-70 HAS-U HCR	$V_{Rk,s,fi(30)}$ [kN]	2,67	4,85	7,94	14,78	23,06	33,23	43,21	52,81
	$V_{Rk,s,fi(60)}$ [kN]	1,93	3,44	5,57	10,37	16,18	23,32	30,32	37,06
	$V_{Rk,s,fi(90)}$ [kN]	1,18	2,03	3,20	5,96	9,30	13,40	17,43	21,30
	$V_{Rk,s,fi(120)}$ [kN]	0,80	1,33	2,02	3,76	5,86	8,44	10,98	13,42
	$M_{Rk,s,fi(30)}^0$ [Nm]	2,73	6,25	12,33	31,34	61,10	105,67	156,68	211,71
	$M_{Rk,s,fi(60)}^0$ [Nm]	1,97	4,43	8,65	21,99	42,87	74,14	109,93	148,55
	$M_{Rk,s,fi(90)}^0$ [Nm]	1,20	2,62	4,97	12,64	24,64	42,61	63,19	85,38
	$M_{Rk,s,fi(120)}^0$ [Nm]	0,82	1,71	3,13	7,96	15,52	26,85	39,81	53,80

Tabelle C43: Charakteristischer Widerstand unter Querlast bei Stahlversagen unter Brandbedingungen

Größe des Verbindungselements		[in.]	3/8	1/2	5/8	3/4	7/8	1	1 1/4
HAS-E-55 HAS-B-105 (HDG)	$V_{Rk,s,fi(30)}$ [kN]		1,50	3,00	4,78	7,08	9,77	12,82	20,50
	$V_{Rk,s,fi(60)}$ [kN]		1,15	2,21	3,52	5,20	7,18	9,42	15,08
	$V_{Rk,s,fi(90)}$ [kN]		0,79	1,41	2,25	3,33	4,60	6,03	9,65
	$V_{Rk,s,fi(120)}$ [kN]		0,61	1,02	1,62	2,39	3,31	4,34	6,94
	$M_{Rk,s,fi(30)}^0$ [Nm]		1,96	4,45	9,77	17,59	28,54	42,88	86,77
	$M_{Rk,s,fi(60)}^0$ [Nm]		1,44	3,39	7,18	12,94	20,98	31,53	63,81
	$M_{Rk,s,fi(90)}^0$ [Nm]		0,92	2,34	4,59	8,28	13,43	20,18	40,84
	$M_{Rk,s,fi(120)}^0$ [Nm]		0,66	1,81	3,30	5,95	9,65	14,50	29,35

Injektionssystem Hilti HIT-RE 500 V4

Leistung
 Charakteristischer Widerstand unter Querlast bei Stahlversagen unter Brandbedingungen

Anhang C40

Tabelle C44: Charakteristischer Widerstand unter Querlast bei Betonausbruch auf der lastabgewandten Seite (Pry-out) unter Brandbedingungen

Größe des Verbindungselements		M8, M10, M12, M16, M20, M24, M27, M30 [in.] 3/8, 1/2, 5/8, 3/4, 7/8, 1, 1 1/4
HAS 5.8, 5.8 HDG HAS 8.8, 8.8 HDG HAS-U 5.8, 5.8 HDG HAS-U 8.8, 8.8 HDG HIT-V 5.8, 5.8F HIT-V 8.8, 8.8F HAS-E-55 HAS-B-105 (HDG) HAS A4 HAS-U A4-70 HAS-U HCR	$V_{Rk,cp,fi(30)}$ [kN] $V_{Rk,cp,fi(60)}$ [kN] $V_{Rk,cp,fi(90)}$ [kN] $V_{Rk,cp,fi(120)}$ [kN]	$k_8 \cdot N_{Rk,c,fi(90)}$ $k_8 \cdot N_{Rk,c,fi(120)}$

Tabelle C45: Charakteristischer Widerstand unter Querlast bei Betonkantenbruch unter Brandbedingungen

Größe des Verbindungselements		M8, M10, M12, M16, M20, M24, M27, M30 [in.] 3/8, 1/2, 5/8, 3/4, 7/8, 1, 1 1/4
HAS 5.8, 5.8 HDG HAS 8.8, 8.8 HDG HAS-U 5.8, 5.8 HDG HAS-U 8.8, 8.8 HDG HIT-V 5.8, 5.8F HIT-V 8.8, 8.8F HAS-E-55 HAS-B-105 (HDG) HAS A4 HAS-U A4-70 HAS-U HCR	$V_{Rk,c,fi(30)}$ [kN] $V_{Rk,c,fi(60)}$ [kN] $V_{Rk,c,fi(90)}$ [kN] $V_{Rk,c,fi(120)}$ [kN]	$0,25 \cdot V_{Rk,c}^0$ $0,20 \cdot V_{Rk,c}^0$

Injektionssystem Hilti HIT-RE 500 V4

Leistung

Charakteristischer Widerstand unter Querlast bei Betonausbruch auf der lastabgewandten Seite (Pry-out) und Betonkantenbruch unter Brandbedingungen

Anhang C41



Evaluation Technique Européenne

ETE-20/0541 du 09/06/2023

(Version originale en langue française)

Partie Générale

Organisme d'Evaluation Technique (TAB) délivrant l'Evaluation Technique Européenne:
Centre Scientifique et Technique du Bâtiment (CSTB)

Nom commercial:

Injection system Hilti HIT-RE 500 V4

Famille de produit:

Cheville à scellement avec tige filetée, fers à béton, douille taraudée HIS-(R)N et cheville de traction Hilti HZA-(R) pour usage dans le béton pour une durée de fonctionnement de 50 et 100 ans

Fabricant:

Hilti Corporation
Feldkircherstrasse 100
FL-9494 Schaan
Principality of Liechtenstein

Usine de fabrication:

Hilti Plant

Cette l'Evaluation Technique Européenne contient:

68 pages incluant 64 pages d'annexes qui font partie intégrante de cette évaluation

Cette Evaluation Technique Européenne est délivrée en accord avec la réglementation (EU) No 305/2011, sur la base de:

EAD 330499-02-0601 version September 2022

Cette Evaluation remplace:

ETE-20/0541 du 04/06/2021

Les traductions de cette Evaluation Technique Européenne dans d'autres langues doivent correspondre pleinement au document original et doivent être identifiées comme telles. La communication de cette évaluation technique européenne, y compris la transmission par voie électronique, doit être complète. Cependant, une reproduction partielle peut être faite, avec le consentement écrit de l'organisme d'évaluation technique d'émission. Toute reproduction partielle doit être identifiée comme telle. La présente Evaluation Technique Européenne peut être retirée par l'Organisme d'Evaluation Technique émetteur, notamment sur information de la Commission conformément à l'article 25, paragraphe 3, du règlement (UE) n° 305/2011.

Partie spécifique

1 Description technique du produit

Le système à injection Hilti HIT-RE 500 V4 est une cheville à scellement consistant en une cartouche de résine Hilti HIT-RE 500 V4 et un élément en acier.

Les éléments sont soit :

- Une tige filetée HAS, HAS-U, Hilti HIT-V, une tige filetée Hilti métrique AM 8.8 ou une tige du commerce avec écrou et rondelle de diamètre M8 à M30 ou de 3/8^e pouce à 1 1/4 de pouce.
- Une barre d'armature (fer à béton) de diamètre $\phi 8$ à $\phi 32$.
- Une cheville Hilti Tension Anchor HZA M12 à M27 ou HZA-R M12 à M24
- Une douille taraudée HIS-(R)N de diamètre M8 à M20 ou 3/8 de pouce à 3/4 de pouce.

L'élément en acier est placé dans un trou foré rempli de résine et ancré via l'adhérence entre l'élément en acier, la résine et le béton.

Un schéma et une description du produit sont donnés en Annexe A.

2 Définition de l'usage prévu

Les performances données en section 3 sont valables si la cheville est utilisée en conformité avec les spécifications et conditions données en Annexes B.

Les dispositions prises dans la présente Evaluation Technique Européen reposent sur l'hypothèse que la durée de vie estimée de la cheville pour l'utilisation prévue est de 50 et 100 ans. Les indications relatives à la durée de vie ne peuvent pas être interprétées comme une garantie donnée par le fabricant, mais ne doivent être considérées que comme un moyen pour choisir les chevilles qui conviennent à la durée de vie économiquement raisonnable attendue des ouvrages.

3 Performance du produit

3.1 Résistance mécanique et stabilité (BWR 1)

Caractéristique essentielle	Performance
Résistances caractéristiques sous chargement statique et quasi statique, Déplacements	Voir Annexes C1 à C28
Résistances caractéristiques pour applications sismiques catégorie C1	Voir Annexes C29 à C35
Résistances caractéristiques pour applications sismiques catégorie C2, Déplacements	Voir Annexe C36 à C38

3.2 Sécurité en cas d'incendie (BWR 2)

Caractéristique essentielle	Performance
Réaction au feu	Les chevilles satisfont aux exigences de la classe A1
Résistance au feu	Voir Annexes C39 à C42

3.3 Hygiène, santé et environnement (BWR 3)

En ce qui concerne les substances dangereuses contenues dans la présente Evaluation Technique Européen, il peut y avoir des exigences applicables aux produits relevant de son domaine d'emploi (exemple: transposition de la législation européenne et des dispositions législatives, réglementaires et nationales). Afin de satisfaire aux dispositions de la directive sur les produits de construction, ces exigences doivent également être respectées, quand et où elles s'appliquent.

3.4 Sécurité d'installation (BWR 4)

Pour les exigences essentielles de Sécurité d'utilisation les mêmes critères que ceux mentionnés dans les exigences essentielles Resistance mécanique et stabilité sont applicables.

3.5 Protection contre le bruit (BWR 5)

Non applicable

3.6 Economie d'énergie et isolation thermique (BWR 6)

Non applicable

3.7 Utilisation durable des ressources naturelles (BWR 7)

Pour l'utilisation durable des ressources naturelles aucune performance a été déterminée pour ce produit.

3.8 Aspects généraux relatifs à l'aptitude à l'emploi

La durabilité et l'aptitude à l'usage ne sont assurées que si les spécifications pour l'usage prévu conformément à l'annexe B1 sont maintenus.

4 Evaluation et vérification de la constance des performances (EVCP)

Conformément à la décision 96/582/EC de la Commission Européenne¹, tel qu'amendée, le système d'évaluation et de vérification de la constance des performances (Voir Annexe V du règlement n° 305/2011 du parlement Européen) donné dans le tableau suivant s'applique.

Produit	Usage prévu	Niveau ou classe	Système
Ancrages métalliques pour le béton	Pour fixer et / ou soutenir dans le béton, des éléments structurels (qui contribuent à la stabilité de l'ouvrage) ou des éléments lourds.	—	1

5 Données techniques nécessaires pour la mise en place d'un système Evaluation et de vérification de la constance des performances (EVCP)

Les données techniques nécessaires à la mise en œuvre du système d'évaluation et de vérification de la constance des performances (EVCP) sont fixées dans le plan de contrôle déposé au Centre Scientifique et Technique du Bâtiment.

Les normes suivantes sont citées dans cette Evaluation Technique Européenne:

- EN 1992-1-1:2004 + AC:2010 Eurocode 2: Design of concrete structures - Part 1-1: General rules and rules for buildings
- EN 1992-1-2:2004 + AC:2008 Eurocode 2: Design of concrete structures - Part 1-2: General rules – Structural fire design
- EN 1992-4:2018 Eurocode 2: Design of concrete structures – Part 4: Design of fastenings for use in concrete
- EN 1993-1-4:2006 + A1:2015 Eurocode 3: Design of steel structures, Part 1-4: General rules – Supplementary rules for stainless steels
- EN 1998-1:2004 + A1:2013 Eurocode 8: Design of structures for earthquake resistance - Part 1: General rules, seismic actions and rules for buildings
- EN 10088-1:2014 Stainless steels – Part 1: List of stainless steels
- EN 206:2013 + A2:2021 Concrete: Specification, performance, production and conformity

¹ Journal officiel des communautés Européennes L 254 du 08.10.1996

Le fabricant doit, sur la base d'un contrat, impliquer un organisme notifié pour les tâches visant la délivrance du certificat de conformité CE dans le domaine des fixations, basé sur ce plan de contrôle.

Délivré à Marne La Vallée le 09/06/2023 par :

Anca CRONOPOL

Cheffe de la division Structure, Maçonnerie et Partition

Procédé installé

Figure A1: Tiges filetées, HAS..., HAS-U..., HAS-..., HIT-V..., AM...8.8 ...

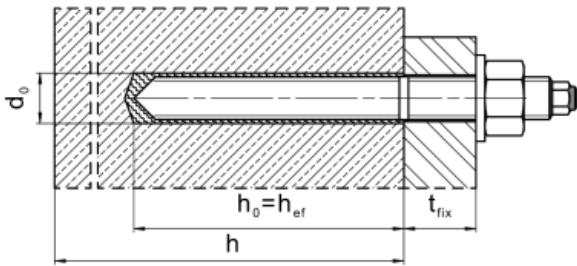

Figure A2: Tiges filetées, HAS..., HAS-U..., HIT-V..., AM...8.8, avec le Hilti Filling Set...

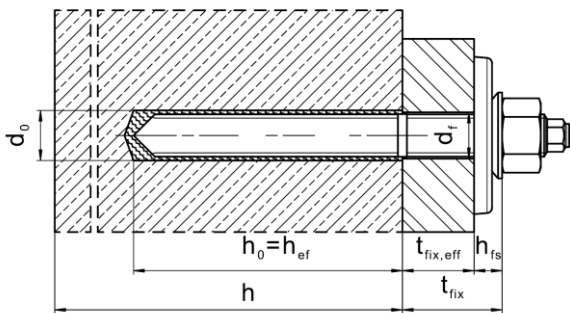

Figure A3: Douille taraudée HIS-(R)N

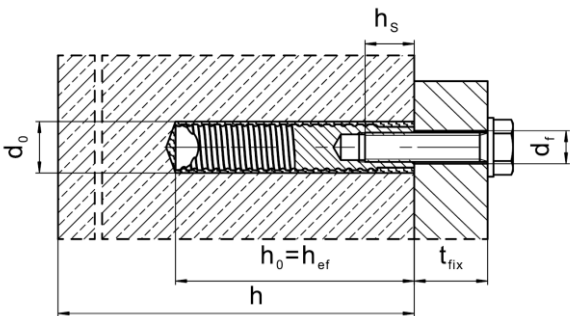
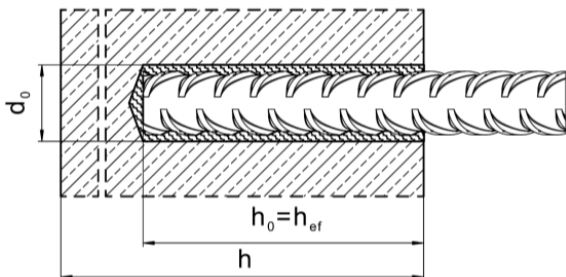

Figure A4: Barre d'armature (rebar)



Injection system Hilti HIT-RE 500 V4

Description du produit
Produit installé

Annexe A1

Description du produit: Mortier d'injection et éléments en acier

Mortier d'injection Hilti HIT-RE 500 V4: Système de résine époxy avec agrégats

330 ml, 500 ml et 1400 ml

Marquage:
HILTI HIT
Nom du produit
Date et ligne de production
Date d'expiration mm/yyyy



Nom du produit: "Hilti HIT-RE 500 V4"

Buse mélangeuse Hilti HIT-RE-M



Éléments en acier

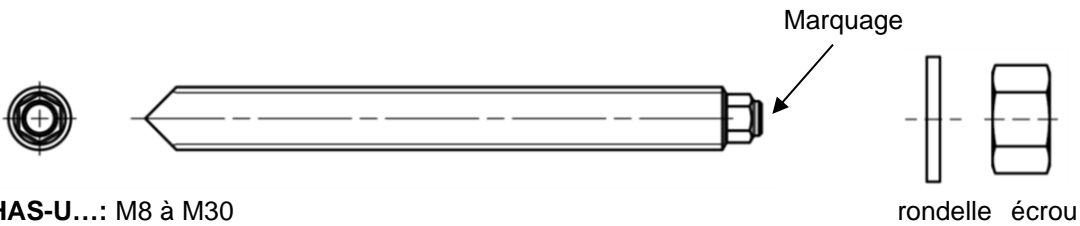

HAS-U...: M8 à M30

Marquage: Classe d'acier et identification de la longueur

- 5 = HAS-U 5.8, 5.8 HDG
- 8 = HAS-U 8.8, 8.8. HDG
- 1 = HAS-U A4
- 2 = HAS-U HCR

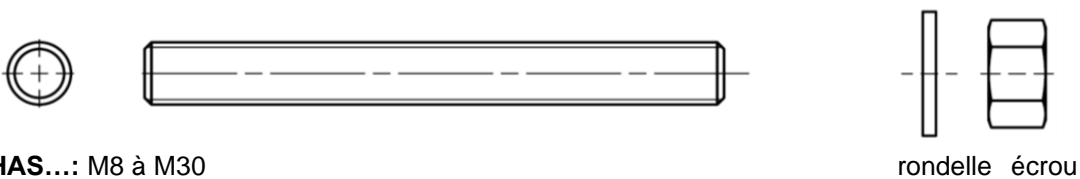

HAS...: M8 à M30

Code couleur du marquage des tiges HAS:

- 5.8 = RAL 5010 (bleu)
- 8.8 = RAL 1023 (jaune)
- A4 = RAL 3000 (rouge)

AM ... 8.8: (HDG) M8 à M30

Injection system Hilti HIT-RE 500 V4

Description du produit
Éléments en acier

Annexe A2

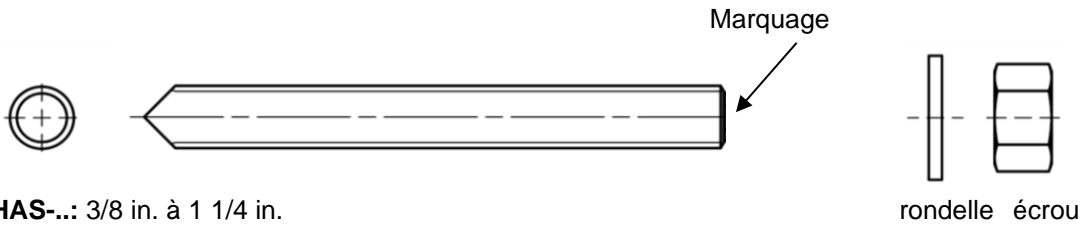

HAS-...: 3/8 in. à 1 1/4 in.

Marquage: Classe d'acier et identification de la longueur [in]

- V = HAS-V-36 (HDG)
- E = HAS-E-55
- B = HAS-B-105 (HDG)
- R1 = HAS-R 304
- R2 = HAS-R 316

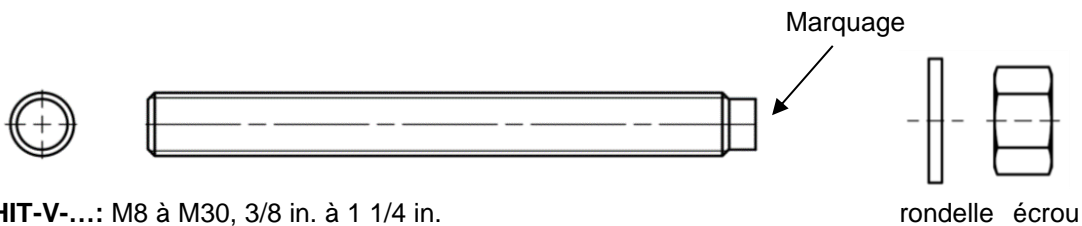

HIT-V-...: M8 à M30, 3/8 in. à 1 1/4 in.

Marquage: e.g.

- 5.8 - l = HIT-V-5.8 M...x l
- 5.8F - l = HIT-V-5.8F M...x l
- 8.8 - l = HIT-V-8.8 M...x l
- 8.8F - l = HIT-V-8.8F M...x l
- R - l = HIT-V-R M ...x l
- HCR - l = HIT-V-HCR M ...x l

Tige filetée standard du commerce: M8 à M30, 3/8 in. à 1 1/4 in.

- Matériaux et propriétés mécaniques selon le Tableau A2.
- Certificat d'inspection 3.1 selon l'EN 10204:2004. Le document doit être conservé.
- Marquage de la profondeur d'ancrage.

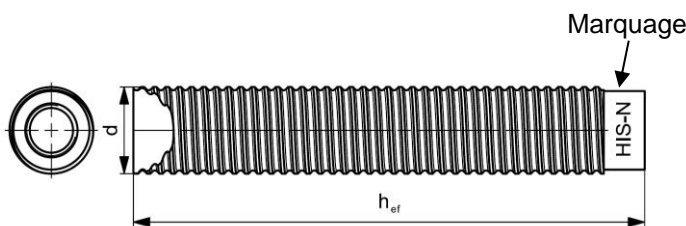

Douille taraudée HIS-(R)N: M8 à M20, 3/8 in. à 3/4 in.

Marquage:

Marque d'identification - HILTI et gravure "HIS-N" (pour l'acier zingué) ou gravure "HIS-RN" (pour l'acier inoxydable)

Injection system Hilti HIT-RE 500 V4

Produit
Eléments en acier

Annexe A3

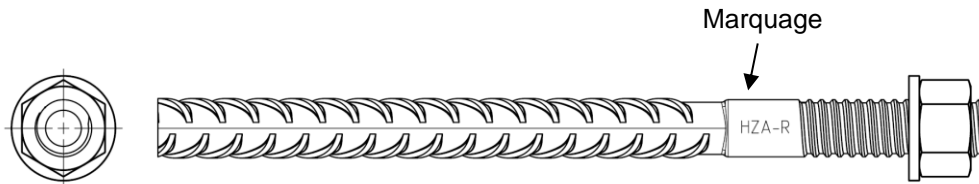

Hilti Tension Anchor HZA: M12 à M27
Hilti Tension Anchor HZA-R: M12 à M24

Marquage:
 gravure "HZA-R" M .. / t_{fix}

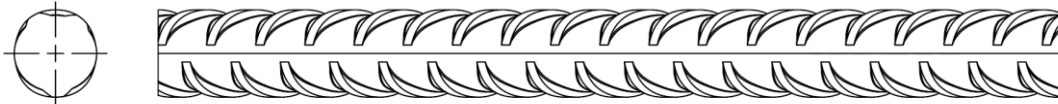

Barre d'armature (rebar): $\phi 8$ to $\phi 32$

- Matériau et propriétés mécaniques selon le Tableau A2.
- Dimensions selon l' Annexe B
- Valeur minimum de la surface relative de la nervure $f_{R,min}$ selon l'EN 1992-1-1:2004+AC:2010
- La hauteur de la nervure de la barre h_{rib} doit être comprise dans la gamme $0,05 \cdot \phi \leq h_{rib} \leq 0,07 \cdot \phi$ (ϕ : diamètre nominal de la barre; h_{rib} : hauteur de la nervure de la barre)

Hilti Filling Set pour combler l'espace annulaire entre la cheville et la pièce à fixer

Rondelle de scellement

Rondelle sphérique



Tableau A1: Géométrie du Hilti Filling Set

Hilti Filling Set		M8	M10	M12	M16	M20	M24
Diamètre de la rondelle de scellement	d_{VS} [mm]	38	42	44	56	60	70
Epaisseur de la rondelle de scellement	h_{VS} [mm]	5			6		
Epaisseur du Hilti Filling Set	h_{fS} [mm]	8	9	10	11	13	15

Injection system Hilti HIT-RE 500 V4

Produit
 Eléments en acier

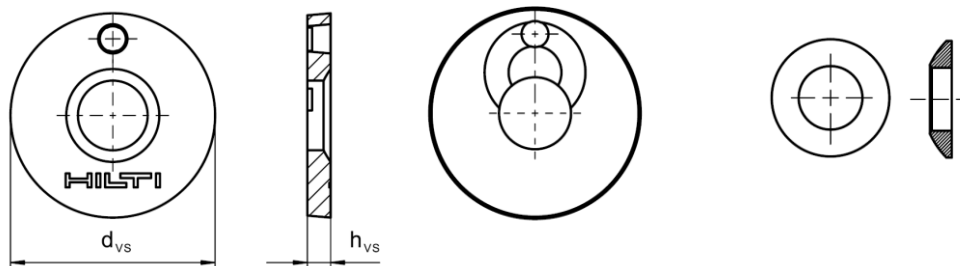
Annexe A4

Tableau A2: Matériaux

Désignation	Matériau
Barre d'armature (rebar)	
Barres d'armature EN 1992-1-1:2004 et AC:2010, Annexe C	Barres et fils redressés de Classe de résistance B ou C avec f_{yk} et k conforme au NDP ou NCL de l'EN 1992-1-1/NA:2013 $f_{uk} = f_{tk} = k \cdot f_{yk}$
Parties métalliques en acier zingué	
HAS 5.8 (HDG), HAS-U-5.8 (HDG), HIT-V-5.8 (F), Tige filetée 5.8	Classe de résistance 5.8, $f_{uk} = 500 \text{ N/mm}^2$, $f_{yk} = 400 \text{ N/mm}^2$ Allongement à rupture ($l_0 = 5d$) > 8% ductile Acier électrozingué $\geq 5 \mu\text{m}$, (F) ou (HDG) version galvanisée à chaud $\geq 50 \mu\text{m}$
Tige filetée 6.8	Classe de résistance 6.8, $f_{uk} = 600 \text{ N/mm}^2$, $f_{yk} = 480 \text{ N/mm}^2$ Allongement à rupture ($l_0 = 5d$) > 8% ductile Acier électrozingué $\geq 5 \mu\text{m}$, (F) ou (HDG) version galvanisée à chaud $\geq 50 \mu\text{m}$
HAS 8.8 (HDG), HAS-U-8.8 (HDG), HIT-V-8.8 (F), AM 8.8 Tige filetée 8.8	Classe de résistance 8.8, $f_{uk} = 800 \text{ N/mm}^2$, $f_{yk} = 640 \text{ N/mm}^2$ Allongement à rupture ($l_0 = 5d$) > 12% ductile Acier électrozingué $\geq 5 \mu\text{m}$, (F) ou (HDG) version galvanisée à chaud $\geq 50 \mu\text{m}$
Hilti tension anchor HZA	Acier lisse avec partie filetée: Acier électrozingué $\geq 5 \mu\text{m}$ Rebar: Barre de classe B selon NDP ou NCL de l'EN 1992-1-1/NA
Douille taraudée HIS-N	Acier électrozingué $\geq 5 \mu\text{m}$
Tige filetée, HIT-V	ASTM A 307 classe A, $f_{uk} = 414 \text{ N/mm}^2$, $f_{yk} = 259 \text{ N/mm}^2$ Allongement à rupture ($l_0 = 5d$) > 8% ductile Acier électrozingué $\geq 5 \mu\text{m}$
Tige filetée, HAS-V-36 (HDG)	ASTM F1554, classe 36, $f_{uk} = 400 \text{ N/mm}^2$, $f_{yk} = 248 \text{ N/mm}^2$ Allongement à rupture ($l_0 = 5d$) > 23% ductile Acier électrozingué $\geq 5 \mu\text{m}$, (HDG) galvanisé à chaud $\geq 53 \mu\text{m}$
Tige filetée, HAS-E-55	ASTM F1554, classe 55, $f_{uk} = 517 \text{ N/mm}^2$, $f_{yk} = 379 \text{ N/mm}^2$ Allongement à rupture ($l_0 = 5d$) > 21% ductile Acier électrozingué $\geq 5 \mu\text{m}$
Tige filetée, HAS-B-105 (HDG)	ASTM F1554, classe 105, $f_{uk} = 862 \text{ N/mm}^2$, $f_{yk} = 724 \text{ N/mm}^2$ Allongement à rupture ($l_0 = 5d$) > 15% ductile Acier électrozingué $\geq 5 \mu\text{m}$, (HDG) galvanisé à chaud $\geq 53 \mu\text{m}$
Rondelle	Acier électrozingué $\geq 5 \mu\text{m}$, version galvanisée à chaud $\geq 50 \mu\text{m}$
Ecrou	Classe de Résistance de l'acier égale ou supérieure à la résistance de la tige filetée. Acier électrozingué $\geq 5 \mu\text{m}$, version galvanisée à chaud $\geq 50 \mu\text{m}$
Hilti Filling Set (F)	Rondelle de scellement: Acier électrozingué $\geq 5 \mu\text{m}$, galvanisée à chaud (F) $\geq 50 \mu\text{m}$ Rondelle sphérique: Acier électrozingué $\geq 5 \mu\text{m}$, (F) galvanisée à chaud $\geq 50 \mu\text{m}$ Ecrou: Acier électrozingué $\geq 5 \mu\text{m}$ (F) Plaqué alliage nickel/zinc $6 \mu\text{m}$

Injection system Hilti HIT-RE 500 V4

Description du produit
Matériaux

Annexe A5

Tableau A2: suite

Parties métalliques en acier inoxydable	
Classe de corrosion (CRC II) selon l' EN 1993-1-4:2006+A1:2015	
Tige filetée	Pour ≤ M24: classe de Résistance 70, $f_{uk} = 700 \text{ N/mm}^2$, $f_{yk} = 450 \text{ N/mm}^2$ Pour > M24: classe de Résistance 50, $f_{uk} = 500 \text{ N/mm}^2$, $f_{yk} = 210 \text{ N/mm}^2$ Allongement à rupture ($l_0 = 5d$) > 12% ductile Acier inoxydable 1.4301, 1.4307, 1.4311, 1.4541, 1.4306, 1.4567 EN 10088-1
Rondelle	Acier inoxydable 1.4301, 1.4307, 1.4311, 1.4541, 1.4306, 1.4567 EN 10088-1
Ecrou	Pour ≤ M24: classe de Résistance 70, $f_{uk} = 700 \text{ N/mm}^2$, $f_{yk} = 450 \text{ N/mm}^2$ Pour > M24: classe de Résistance 50, $f_{uk} = 500 \text{ N/mm}^2$, $f_{yk} = 210 \text{ N/mm}^2$ Acier inoxydable 1.4301, 1.4307, 1.4311, 1.4541, 1.4306, 1.4567 selon l'EN 10088-1: 2014
Tige filetée, HAS-R 304	Taille 3/8 in. à 5/8 in.: ASTM F593 CW1, $f_{uk} = 689 \text{ N/mm}^2$, $f_{yk} = 448 \text{ N/mm}^2$ Allongement à rupture ($l_0 = 5d$) > 12% ductile Taille 3/4 in. à 1 in.: ASTM F593 CW2, $f_{uk} = 586 \text{ N/mm}^2$, $f_{yk} = 310 \text{ N/mm}^2$ Allongement à rupture ($l_0 = 5d$) > 12% ductile Taille > 1 in.: ASTM A193 Classe 8 M, class 1, $f_{uk} = 515 \text{ N/mm}^2$, $f_{yk} = 205 \text{ N/mm}^2$ Allongement à rupture ($l_0 = 5d$) > 12% ductile
Rondelle	Acier inoxydable ASTM F593 et ASTM A193
Ecrou	Classe de Résistance de l'acier adaptée à la résistance de la tige filetée
Parties métalliques en acier inoxydable	
Classe de corrosion (CRC III) selon l' EN 1993-1-4	
HAS A4, HAS-U A4, HIT-V-R, Tige filetée A4	Pour ≤ M24: classe de Résistance 70, $f_{uk} = 700 \text{ N/mm}^2$, $f_{yk} = 450 \text{ N/mm}^2$ Pour > M24: classe de Résistance 50, $f_{uk} = 500 \text{ N/mm}^2$, $f_{yk} = 210 \text{ N/mm}^2$ Allongement à rupture ($l_0 = 5d$) > 12% ductile Acier inoxydable selon 1.4401, 1.4404, 1.4578, 1.4571, 1.4439, 1.4362 EN 10088-1
Hilti Tension anchor HZA-R	Acier cylindrique avec une partie filetée: Acier inoxydable selon l'EN 10088-1:2014 Rebar: Barres de classe B selon NDP ou NCL de l'EN 1992-1-1/NA:2013
Douilles taraudées HIS-RN	Acier inoxydable 1.4401, 1.4571 selon l'EN 10088-1
Tige filetée, HAS-R 316	Taille 3/8 in. à 5/8 in.: ASTM F593 CW1, $f_{uk} = 689 \text{ N/mm}^2$, $f_{yk} = 448 \text{ N/mm}^2$ Allongement à rupture ($l_0 = 5d$) > 12% ductile Taille 3/4 in. à 1 1/4 in.: ASTM F 593 CW2, $f_{uk} = 586 \text{ N/mm}^2$, $f_{yk} = 310 \text{ N/mm}^2$ Allongement à rupture ($l_0 = 5d$) > 12% ductile
Rondelle	Acier inoxydable ASTM F593
Ecrou	Classe de Résistance de l'acier égale ou supérieure à la résistance de la tige filetée
Hilti Filling Set A4	Rondelle de remplissage: Acier inoxydable selon l'EN 10088-1: 2014 Rodelle sphérique: Acier inoxydable selon l'EN 10088-1: 2014 Ecrou: Acier inoxydable selon l'EN 10088-1: 2014

Injection system Hilti HIT-RE 500 V4

Description du produit
Matériaux

Annexe A6

Tableau A2: suite

Parties métalliques en acier à haute résistance à la corrosion	
Classe de corrosion (CRC V) selon l' EN 1993-1-4	
HAS-U HCR, HIT-V-HCR Tige filetée	Pour $\leq M20$: $f_{uk} = 800 \text{ N/mm}^2$, $f_{yk} = 640 \text{ N/mm}^2$ Pour $> M20$: $f_{uk} = 700 \text{ N/mm}^2$, $f_{yk} = 400 \text{ N/mm}^2$ Allongement à rupture ($l_0 = 5d$) $> 12\%$ ductile Acier à haute résistance à la corrosion 1.4529, 1.4565 selon l'EN 10088-1
Rondelle	Acier à haute résistance à la corrosion 1.4529, 1.4565 selon l'EN 10088-1
Ecrou	Classe de Résistance de l'acier adaptée à la résistance de la tige filetée. Acier à haute résistance à la corrosion 1.4529, 1.4565 selon l'EN 10088-1

Injection system Hilti HIT-RE 500 V4

Description du produit
Matériaux

Annexe A7

Précisions sur l'emploi prévu

Ancrages soumis à:

- Chargements statiques ou quasi statiques
- Performance sismique de catégorie C1
- Performance sismique de catégorie C2 (HAS (8.8, 8.8 HDG, A4), HAS-U (8.8, 8.8 HDG, A4, HCR), HIT-V (-8.8, -8.8F, -R, -HCR), AM (8.8, 8.8 HDG) et tiges filetées standards (classe 8.8, A4, HCR)), avec le perçage par percussion et le perçage par percussion avec les Hilti Hollow Drill Bit TE-CD, TE-YD.
- Exposition au feu: tiges filetées de taille M8 à M30 (HAS (5.8, 5.8 HDG, 8.8, 8.8 HDG, A4-70), (HAS-U (5.8, 5.8 HDG, 8.8, 8.8 HDG, A4-70, HCR), HIT-V (5.8, 5.8F, 8.8, 8.8F, R, HCR), 3/8 à 1 1/4 (HAS-E-55, HAS-B-105 (HDG))).

Matériaux supports :

- Béton armé ou non armé de masse volumique courante, non fibré, conforme à l'EN 206:2013+A1:2016.
- Béton de classe de résistance C20/25 à C50/60 conforme à l'EN 206:2013+A1:2016.
- Béton non fissuré et fissuré.

Température des matériaux supports

- **A l'installation**
-5 °C à +40 °C pour la variation standard de la température après l'installation
- **En service**
Plage de température I: -40 °C à +40 °C
(température max. à long terme +24 °C et température max à court terme +40 °C)
Plage de température II: -40 °C à +55 °C
(température max. à long terme +43 °C et température max à court terme +55 °C)
Plage de température III: -40 °C à +75 °C
(température max. à long terme +55 °C et température max à court terme +75 °C)

Conditions d'emploi (conditions d'environnement) :

- Structures soumises à une ambiance intérieure sèche (tous matériaux).
- Pour toutes les autres conditions selon l'EN 1993-1-4, les classes de résistance à la corrosion de l'annexe A (Acier inoxydable et acier à haute résistance à la corrosion).

Dimensionnement:

- Les ancrages sont conçus sous la responsabilité d'un ingénieur expert en ancrages et travaux de bétonnage.
- Des plans et notes de calculs vérifiables sont préparés en tenant compte des charges devant être ancrées. La position de la cheville est indiquée sur les plans de conception (e. g. la position de la cheville par rapport aux armatures ou au support).
- Les ancrages sont dimensionnés conformément à l'EN 1992-4. Les ancrages sous actions sismiques doivent être positionnés en dehors de régions critiques (par ex. des rotules plastiques) de la structure en béton. Les fixations en installation déportées ou avec une couche de mortier de calage sous actions sismiques ne sont pas couvertes par l'Evaluation Technique Européenne (ETE).
- Pour les applications avec une résistance sous exposition au feu, les fixations sont dimensionnées selon le EOTA TR 082 "Design of bonded fasteners in concrete under fire conditions"

Injection system Hilti HIT-RE 500 V4

Intended use
Specifications

Annexe B1

Pose:

- Catégorie d'utilisation:
 - Béton sec ou humide (sauf trous inondés): toutes méthodes de perçage
 - Trous remplis d'eau : perçage par rotation-percussion seulement, pour béton non fissuré seulement
- Méthode de perçage:
 - Perforateur,
 - Perforateur avec Hilti hollow drill bit TE-CD, TE-YD,
 - Carottage diamant, pour béton non fissuré seulement,
 - Carottage diamant avec une abrasion avec l'outil abrasif Hilti TE-YRT.
- Direction d'installation D3: vers le bas, l'horizontale ou vers le haut (par ex. au plafond). Tous les éléments sont concernés.
- Installation des ancrages réalisée par du personnel qualifié et sous la supervision de la personne responsable des questions techniques sur le chantier.

<p>Injection system Hilti HIT-RE 500 V4</p>	<p>Annexe B2</p>
<p>Utilisation prévue Spécifications</p>	

Tableau B1: Paramètres d'installation des tiges filetées métriques selon l'Annexe A

Tiges filetées métriques selon l'Annexe A			M8	M10	M12	M16	M20	M24	M27	M30
Diamètre de l'élément	d	[mm]	8	10	12	16	20	24	27	30
Diamètre nominal du foret	d_0	[mm]	10	12	14	18	22	28	30	35
Profondeur d'ancrage effective et profondeur du trou	h_{ef}	[mm]	60 à 160	60 à 200	70 à 240	80 à 320	90 à 400	96 à 480	108 à 540	120 à 600
Diamètre maximum du trou de passage dans la pièce à fixer	d_f	[mm]	9	12	14	18	22	26	30	33
Epaisseur du Hilti filling set	h_{fs}	[mm]	-	-	10	11	13	15	-	-
Epaisseur à fixer effective avec le Hilti filling set	$t_{fix,eff}$	[mm]	$t_{fix,eff} = t_{fix} + h_{fs}$							
Epaisseur minimum de béton	h_{min}	[mm]	$h_{ef} + 30$ ≥ 100 mm			$h_{ef} + 2 \cdot d_0$				
Couple maximum	$max. T_{inst}$	[Nm]	10	20	40	80	150	200	270	300
Entraxe minimum	s_{min}	[mm]	40	50	60	75	90	115	120	140
Distance du bord minimum	c_{min}	[mm]	40	45	45	50	55	60	75	80

Tableau B2: Paramètres d'installation des tiges filetées impériales selon l'Annexe A

Tige filetée tiges filetées impériales selon l'Annexe A		[in.]	3/8	1/2	5/8	3/4	7/8	1	1 1/4
Diamètre de l'élément	d	[mm]	9,5	12,7	15,9	19,1	22,2	25,4	31,8
Diamètre nominal du foret	d_0	[in.]	7/16	9/16	3/4	7/8	1	1 1/8	1 3/8
Surface effective de la section	$A_s^{1)}$	[mm ²]	50	92	146	216	298	391	625
Profondeur d'ancrage effective et profondeur du trou	h_{ef}	[mm]	60 à 191	70 à 254	79 à 318	89 à 381	89 à 445	102 à 508	127 à 635
Diamètre maximum du trou de passage dans la pièce à fixer	d_f	[mm]	11,1	14,3	17,5	20,6	23,8	28,6	34,9
Epaisseur minimum de béton	h_{min}	[mm]	$h_{ef} + 30$ ≥ 100 mm		$h_{ef} + 2 \cdot d_0$				
Couple maximum	$max. T_{inst}$	[Nm]	20	41	81	136	169	203	271
Entraxe minimum	s_{min}	[mm]	45	60	80	90	105	115	140
Distance du bord minimum	c_{min}	[mm]	45	45	50	55	60	70	80

1) Section utile pour le calcul de la résistance caractéristique de l'acier.

Injection system Hilti HIT-RE 500 V4

Mode d'emploi
Paramètres d'installation

Annexe B3

Tableau B3: Paramètres d'installation des douilles taraudées HIS-(R)N

Douille taraudée HIS-(R)N			M8	M10	M12	M16	M20
Diamètre extérieur de la gaine	d	[mm]	12,5	16,5	20,5	25,4	27,6
Diamètre nominal du foret	d_0	[mm]	14	18	22	28	32
Profondeur d'ancrage effective et profondeur du trou	h_{ef}	[mm]	90	110	125	170	205
Diamètre maximum du trou de passage dans la pièce à fixer	d_f	[mm]	9	12	14	18	22
Epaisseur du Hilti Filling Set	h_{fs}		8	9	10	11	13
Epaisseur à fixer effective avec le Hilti filling set	$t_{fix,eff}$	[mm]	$t_{fix,eff} = t_{fix} + h_{fs}$				
Epaisseur minimum de béton	h_{min}	[mm]	120	150	170	230	270
Couple maximum	max. T_{inst}	[Nm]	10	20	40	80	150
Longueur d'engagement du filetage min à max	h_s	[mm]	8 à 20	10 à 25	12 à 30	16 à 40	20 à 50
Entraxe minimum	s_{min}	[mm]	60	75	90	115	130
Distance du bord minimum	c_{min}	[mm]	40	45	55	65	90

Tableau B4: Paramètres d'installation des douilles taraudées HIS-(R)N

Douille taraudée HIS-(R)N			3/8	1/2	5/8	3/4
Diamètre extérieur de la gaine	d	[mm]	16,5	20,5	25,4	27,6
Diamètre nominal du foret	d_0	[in.]	11/16	7/8	1 1/8	1
Profondeur d'ancrage effective et profondeur du trou	h_{ef}	[mm]	110	125	170	205
Diamètre maximum du trou de passage dans la pièce à fixer	d_f	[mm]	11,1	14,3	17,5	20,6
Epaisseur minimum de béton	h_{min}	[mm]	150	170	230	270
Couple maximum	max. T_{inst}	[Nm]	20	41	81	136
Longueur d'engagement du filetage min à max	h_s	[mm]	10 à 25	12 à 30	16 à 40	20 à 50
Entraxe minimum	s_{min}	[mm]	70	90	115	130
Distance du bord minimum	c_{min}	[mm]	45	55	65	90

Injection system Hilti HIT-RE 500 V4

Mode d'emploi
Paramètres d'installation

Annex B4

Tableau B5: Paramètres d'installation des chevilles de traction Hilti HZA / HZA-R

HZA		M12	M16	M20	M24	M27
HZA-R		M12	M16	M20	M24	-
Diamètre de la barre d'armature	ϕ [mm]	12	16	20	25	28
Profondeur nominale d'ancrage et profondeur du trou HZA	h_0 [mm]	90 à 240	100 à 320	110 à 400	120 à 500	140 à 560
Profondeur nominale d'ancrage et profondeur du trou HZA -R	h_0 [mm]	170 à 240	180 à 320	190 à 400	200 à 500	-
Profondeur d'ancrage effective HZA ($h_{ef} = h_{nom} - l_e$)	h_{ef} [mm]	$h_{nom} - 20$				
Profondeur d'ancrage effective HZA-R ($h_{ef} = h_{nom} - l_e$)	h_{ef} [mm]	$h_{nom} - 100$				
Longueur lisse de l'axe HZA	l_e [mm]	20				
Longueur lisse de l'axe HZA-R	l_e	100				
Diamètre nominal du foret	d_0 [mm]	16	20	25	32	35
Diamètre maximum du trou de passage dans la pièce à fixer	d_f [mm]	14	18	22	26	30
Epaisseur du Hilti Filling Set	h_{fs} [mm]	10	11	13	15	-
Epaisseur effective avec le Hilti Filling Set	$t_{fix,eff}$ [mm]	$t_{fix,eff} = t_{fix} - h_{fs}$				
Couple d'installation maximum	max. T_{inst} [Nm]	40	80	150	200	270
Epaisseur minimum de béton	h_{min} [mm]	$h_{nom} + 2 \cdot d_0$				
Entraxe minimum	s_{min} [mm]	65	80	100	130	140
Distance du bord minimum	c_{min} [mm]	45	50	55	60	75

Tableau B6: Paramètres d'installation des barres d'armature (rebar)

Barre d'armature (rebar)	ϕ 8	ϕ 10	ϕ 12	ϕ 14	ϕ 16	ϕ 20	ϕ 25	ϕ 28	ϕ 30	ϕ 32
Diamètre ϕ [mm]	8	10	12	14	16	20	25	28	30	32
Profondeur d'ancrage effective et profondeur du trou h_{ef} [mm]	60 à 160	60 à 200	70 à 240	75 à 280	80 à 320	90 à 400	100 à 500	112 à 560	120 à 600	128 à 640
Diamètre nominal du foret d_0 [mm]	10 ¹⁾ 12 ¹⁾	12 ¹⁾ 14 ¹⁾	14 ¹⁾ 16 ¹⁾	18	20	25	30 ¹⁾ 32 ¹⁾	35	37	40
Epaisseur minimum de béton h_{min} [mm]	$h_{ef} + 30$ ≥ 100 mm			$h_{ef} + 2 \cdot d_0$						
Entraxe minimum s_{min} [mm]	40	50	60	70	80	100	125	140	150	160
Distance du bord minimum c_{min} [mm]	40	45	45	50	50	65	70	75	80	80

1) Chacune des deux valeurs données peut être utilisée

Injection system Hilti HIT-RE 500 V4

Mode d'emploi
Paramètres d'installation

Annexe B5

Tableau B7: Temps d'utilisation et de durcissement¹⁾²⁾

Température du matériau support T	Temps d'utilisation maximal t _{work}	Temps de durcissement minimal t _{cure} ¹⁾
-5 °C à -1 °C	2 heures	168 heures
0 °C à 4 °C	2 heures	48 heures
5 °C à 9 °C	2 heures	24 heures
10 °C à 14 °C	1,5 heures	16 heures
15 °C à 19 °C	1 heures	12 heures
20 °C à 24 °C	30 min	7 heures
25 °C à 29 °C	20 min	6 heures
30 °C à 34 °C	15 min	5 heures
35 °C à 39 °C	12 min	4,5 heures
40 °C	10 min	4 heures

1) Les temps de durcissement fournis sont valables pour un matériau support sec seulement. Dans un matériau support humide les temps de durcissement doivent être doublés

2) La température minimum de la cartouche est de +5°C

Injection system Hilti HIT-RE 500 V4

Mode d'emploi
Temps d'utilisation et temps de durcissement

Annexe B6

Tableau B8: Paramètres d'installation et de nettoyage

Eléments				Perçage et nettoyage				Installation	
Tiges filetés, HAS-U-... HIT-V-... AM...8.8	HIS-(R)N	Rebar	HZA(-R)	Perçage par percussion		Carottage diamant		Brosse	Douille
					Foret aspirant TE-CD, TE-YD ¹⁾		Outil abrasif TE-YRT		
Taille	Name	Taille	Taille	d ₀ [mm]	d ₀ [mm]	d ₀ [mm]	d ₀ [mm]	HIT-RB	HIT-SZ
M8	-	φ8	-	10	10	10	-	10	-
M10	-	φ8, φ10	-	12	12	12	-	12	12
M12	M8	φ10, φ12	-	14	14	14	-	14	14
-	-	φ12	M12	16	16	16	-	16	16
M16	M10	φ14	-	18	18	18	18	18	18
-	-	φ16	M16	20	20	20	20	20	20
M20	M12	φ18	-	22	22	22	22	22	22
-	-	φ20	M20	25	25	25	25	25	25
M24	M16	-	-	28	28	28	28	28	28
M27	-	φ24, φ25	-	30	-	30	30	30	30
-	M20	φ24, φ25	M24	32	32	32	32	32	32
M30	-	φ28	M27	35	35	35	35	35	35
-	-	φ30	-	37	-	37	-	37	37
-	-	φ32	-	40	-	-	-	40	40
-	-			-	-	42	-	42	42

¹⁾ Avec un aspirateur Hilti VC 10/20/40 (nettoyage automatique du filtre activé) ou aspirateur équivalent en termes de performances en combinaison avec le Hilti hollow drill bit TE-CD or TE-YD spécifié.









Injection system Hilti HIT-RE 500 V4

Mode d'emploi

Options d'installation / Paramètres d'installation et de nettoyage

Annexe B7

Tableau B9: Paramètres d'installation et de nettoyage

Éléments		Perçage et nettoyage				Installation	
Tiges filetées, HAS-... HIT-V-...	HIS-(R)N	Perçage par percussion		Carottage diamant		Brosse	Douille
			Foret aspirant TE-CD, TE-YD ¹⁾		Outil abrasif TE-YRT		
							
Taille [in]	Taille [in]	do [in.]	do [in.]	do [in.]	do [in.]	HIT-RB	HIT-SZ
3/8	-	7/16	-	7/16	-	7/16	7/16
1/2	-	9/16	9/16	9/16	-	9/16	9/16
-	3/8	11/16	-	11/16	-	11/16	11/16
5/8	-	3/4	3/4	3/4	3/4	3/4	3/4
3/4	1/2	7/8	7/8	7/8	7/8	7/8	7/8
7/8	-	1	1	1	1	1	1
1	5/8	1 1/8	1 1/8	1 1/8	1 1/8	1 1/8	1 1/8
-	3/4	1 1/4	-	1 1/4	-	1 1/4	1 1/4
1 1/4	-	1 3/8	-	1 3/8	1 3/8	1 3/8	1 3/8

¹⁾ Avec un aspirateur Hilti VC 10/20/40 (nettoyage automatique du filtre activé) ou aspirateur équivalent en termes de performances en combinaison avec le Hilti hollow drill bit TE-CD or TE-YD spécifié.

Injection system Hilti HIT-RE 500 V4

Mode d'emploi

Options d'installation / Paramètres d'installation et de nettoyage

Annexe B8

Tableau B10: Méthodes de nettoyage alternatives



<p>Nettoyage par air comprimé (CAC): La buse d'air a une ouverture d'au moins 3,5 mm (1/7 in.) de diamètre</p>	
<p>Nettoyage automatique (AC): Le nettoyage est réalisé au cours du perçage avec les systèmes Hilti TE-CD et TE-YD comprenant un nettoyage par aspiration</p>	

Tableau B11: Paramètres d'utilisation de l'outil abrasif Hilti TE-YRT



Carottage diamant			Outil abrasif TE-YRT		Témoin d'usure RTG...	
						
d ₀					taille	
nominal [mm]	nominal [in.]	mesuré [mm]	d ₀ [mm]	d ₀ [in.]		
18	3/4	17,9 à 18,2	18	3/4	18	3/4
20	7/8	19,9 à 20,2	20	7/8	20	7/8
22	1	21,9 à 22,2	22	1	22	1
25	1 1/8	24,9 à 25,2	25	1 1/8	25	1 1/8
28	1 3/8	27,9 à 28,2	28	1 3/8	28	1 3/8
30	-	29,9 à 30,2	30	-	30	-
32	-	31,9 à 32,2	32	-	32	-
35	-	34,9 à 35,2	35	-	35	-

Tableau B12: Paramètres d'utilisation du Hilti Roughening tool TE-YRT

h _{ef} [mm]	Temps d'abrasion t _{abrasion} (t _{abrasion} [sec] = h _{ef} [mm] / 10)
0 à 100	10
101 à 200	20
201 à 300	30
301 à 400	40
401 à 500	50
501 à 600	60

Tableau B13: Outil abrasif Hilti TE-YRT et témoin d'usure RTG

TE-YRT	
RTG	

Injection system Hilti HIT-RE 500 V4

Mode d'emploi

Nettoyage alternatif / Utilisation du Hilti Roughening tool TE-YRT

Annexe B9

Instruction de pose

Perçage du trou

a) Perçage par percussion: Pour béton sec ou humide et installation dans des trous inondés (sauf eau de mer)

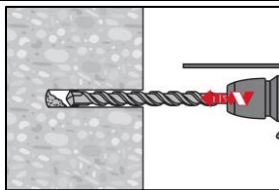

Perçer le trou à la profondeur d'implantation requise en utilisant un marteau perforateur en rotation-percussion et une mèche au carbure de diamètre approprié.

b) Perçage par percussion avec Foret aspirant Hilti TE-CD, TE-YD: Pour béton sec et humide seulement

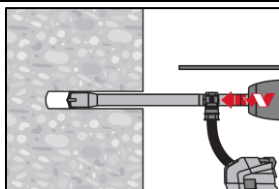

Perçer le trou à la profondeur d'implantation requise avec la mèche de taille appropriée Hilti TE-CD ou TE-YD Hollow Drill Bit avec système d'aspiration Hilti VC 10/20/40 (système de nettoyage automatique du filtre activé, mode éco désactivé) ou aspirateur équivalent en termes de performances en combinaison avec le Hilti hollow drill bit TE-CD or TE-YD spécifié. Ce système de perçage retire la poussière et nettoie le trou durant le perçage lorsque utilisé en accord avec le manuel d'utilisation. Lors de l'utilisation de la mèche TE-CD 14, se référer au tableaux B8 et B9. Une fois le perçage terminé, passer à l'étape "Préparation du système d'injection" dans les instructions d'installation.

c) Carottage diamant: Pour béton sec et humide seulement

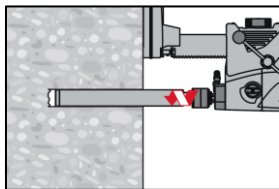

Le carottage diamant est permis lorsque le système de carottage de diamètre approprié est utilisé.

d) Carottage diamant avec une abrasion avec l'outil abrasif Hilti TE-YRT: Pour béton sec et humide seulement

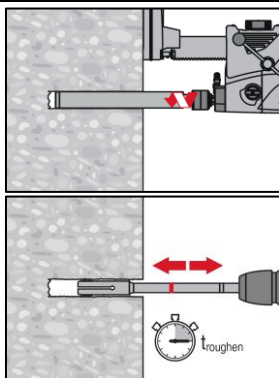

Le carottage diamant est permis lorsque le système de carottage de diamètre approprié est utilisé.

Pour une utilisation combinée avec l'outil abrasif Hilti TE-YRT, se référer aux paramètres du Tableau B8 et du tableau B9. Avant abrasion les parois du trou doivent être sèches. Vérifier l'usure de l'outil abrasif avec le témoin d'usure RTG. Abraser les parois du trou sur toute la longueur requise h_{ef} .

Injection system Hilti HIT-RE 500 V4

Mode d'emploi
Instructions d'installation

Annexe B10

Nettoyage du trou: Juste avant d'installer la cheville, le trou doit être nettoyé de toute poussière ou débris.
Nettoyage inapproprié = faible résistance à la traction

Nettoyage à air comprimé (CAC) pour tous diamètres de trou d_0 et toutes profondeurs de trou h_0

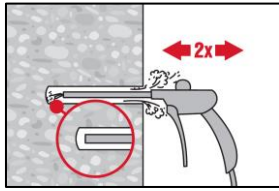

Souffler 2 fois depuis le fond du trou (si nécessaire avec une extension) avec de l'air comprimé exempt d'huile (minimum 6 bars à 6 m³/h) jusqu'à ce que l'air qui ressort soit exempt de poussière notable.

Pour le trou de diamètre ≥ 32 mm, le compresseur doit fournir un débit d'air d'au moins 140 m³/heure.

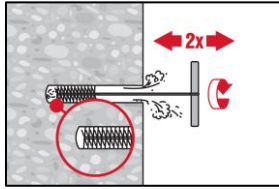

Brosser 2 fois avec la brosse de taille spécifiée (voir le Tableau B8 et le Tableau B9) en insérant la brosse métallique ronde Hilti HIT-RB au fond du trou (si nécessaire en utilisant une extension) avec un mouvement tournant puis en le retirant.

L'écouvillon doit présenter une résistance naturelle à l'entrée dans le trou (\varnothing écouvillon $\geq \varnothing$ trou). Si ce n'est pas le cas, la brosse est trop petite et doit être remplacée par une brosse de diamètre adapté.

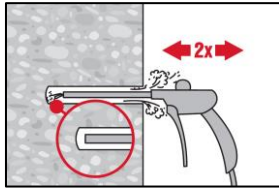

Souffler 2 fois encore avec de l'air comprimé jusqu'à ce que l'air qui ressort soit exempt de poussière notable.

Injection system Hilti HIT-RE 500 V4

Mode d'emploi
Instructions d'installation

Annexe B11

Nettoyage et suppression de l'eau d'un trou percé par percussion et rempli d'eau et d'un trou percé par carottage diamant :

Pour tous diamètres de perçage d_0 et toutes profondeurs de trou h_0

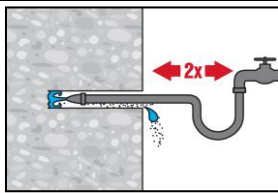

Rincer deux fois en insérant un tuyau d'eau (à pression courante) au fond du trou jusqu'à ce que l'eau devienne claire.

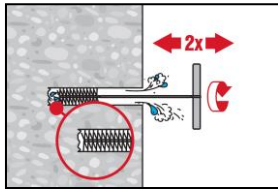

Brosser 2 fois avec la brosse de taille spécifiée (voir le Tableau B8 et le Tableau B9) en insérant la brosse métallique ronde Hilti HIT-RB au fond du trou (si nécessaire en utilisant une extension) avec un mouvement tournant puis en le retirant. L'écouvillon doit présenter une résistance naturelle à l'entrée dans le trou (\varnothing écouvillon $\geq \varnothing$ trou). Si ce n'est pas le cas, la brosse est trop petite et doit être remplacée par une brosse de diamètre adapté.

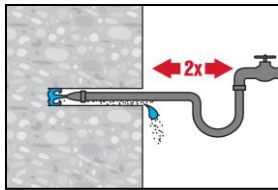

Rincer à nouveau deux fois en insérant un tuyau d'eau (à pression courante) au fond du trou jusqu'à ce que l'eau devienne claire.

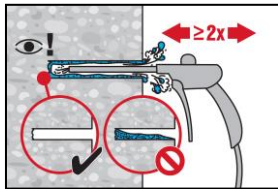

Souffler 2 fois depuis le fond du trou (si nécessaire avec une extension) avec de l'air comprimé exempt d'huile (minimum 6 bars à 6 m³/h) jusqu'à ce que l'air qui en ressort soit exempt de poussière et d'eau.

Pour les trous de diamètre ≥ 32 mm, le compresseur doit fournir un débit d'air d'au moins 140 m³/heure.

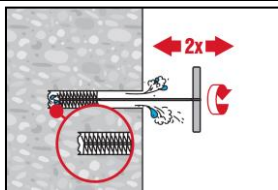

Brosser 2 fois avec la brosse de taille spécifiée (voir le Tableau B8 et le Tableau B9) en insérant la brosse métallique ronde Hilti HIT-RB au fond du trou (si nécessaire en utilisant une extension) avec un mouvement tournant puis en le retirant. L'écouvillon doit présenter une résistance naturelle à l'entrée dans le trou (\varnothing écouvillon $\geq \varnothing$ trou). Si ce n'est pas le cas, la brosse est trop petite et doit être remplacée par une brosse de diamètre adapté.

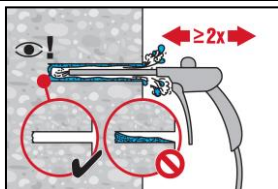

Souffler 2 fois depuis le fond du trou (si nécessaire avec une extension) avec de l'air comprimé exempt d'huile (minimum 6 bars à 6 m³/h) jusqu'à ce que l'air qui en ressort soit exempt de poussière et d'eau.

Injection system Hilti HIT-RE 500 V4

Mode d'emploi
Instructions d'installation

Annexe B12

Nettoyage de trous percés par carottage diamant avec une abrasion avec l'outil abrasif Hilti TE-YRT:

Pour tous diamètres de trou d_0 et toutes profondeurs de trou h_0

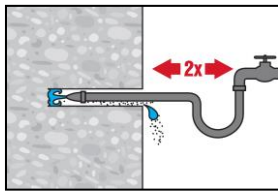

Rincer deux fois en insérant un tuyau d'eau au fond du trou jusqu'à ce que l'eau devienne claire.

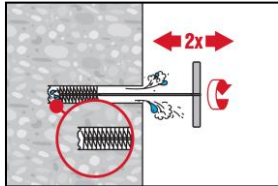

Brossage 2 fois avec la brosse de taille spécifiée (\varnothing écouvillon $\geq \varnothing$ trou, voir Tableaux B8 et B9) en insérant la brosse métallique rond Hilti HIT-RB au fond du trou (si nécessaire utiliser une extension) avec un mouvement tournant puis en le retirant. La brosse doit présenter une résistance naturelle à l'entrée dans le trou. Si ce n'est pas le cas, utiliser un nouvel écouvillon ou un écouvillon de diamètre supérieur.

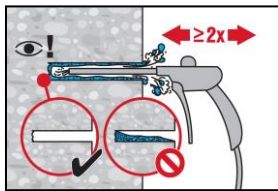

Souffler 2 fois depuis le fond du trou (si nécessaire avec une extension) avec de l'air comprimé exempt d'huile (minimum 6 bars à 6 m³/h) jusqu'à ce que l'air qui ressort soit exempt de poussière notable.

Pour les trous de diamètre ≥ 32 mm, le compresseur doit fournir un débit d'air d'au moins 140 m³/heure.

Préparation de l'injection

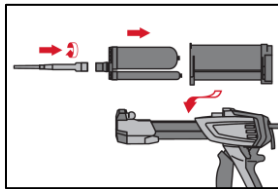

Fixer soigneusement la buse mélangeuse Hilti HIT-RE-M au support de la cartouche souple. Ne pas modifier la buse mélangeuse.

Respecter les instructions d'utilisation du pistolet à injecter

Vérifier le fonctionnement du support de cartouche. Insérer la cartouche souple sur son support et le support dans le pistolet à injecter.

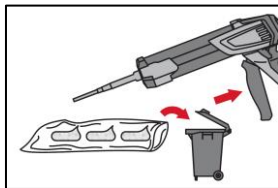

La cartouche s'ouvre automatiquement lorsque l'injection commence. En fonction de la taille de la cartouche, une première quantité de résine doit être éliminée.

Quantités à éliminer: 3 pressions pour une cartouche de 330 ml,
4 pressions pour une cartouche de 500 ml,
65 ml pour une cartouche de 1400 ml.

La température minimum de la cartouche est de +5°C.

Injection system Hilti HIT-RE 500 V4

Mode d'emploi
Instructions d'installation

Annexe B13

Injection de la résine

Injecter depuis le fond du trou sans former de vides

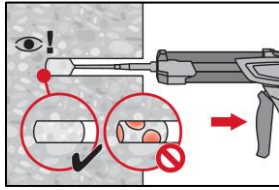

Injecter la résine à partir du fond du trou vers l'extrémité et retirer lentement et progressivement la buse mélangeuse après chaque pression.

Remplir le trou jusqu'à peu près les 2/3, ou comme demandé pour assurer que l'espace annulaire entre l'élément en acier et le béton soit complètement rempli sur toute la longueur d'implantation.

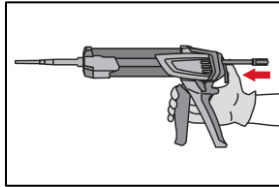

Après l'injection, dépressuriser le pistolet d'injection en pressant le bouton de déverrouillage. Ceci permettra d'éviter que la résine continue de s'écouler.

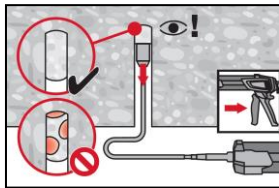

Application au plafond et installation avec des profondeurs $h_{ef} > 250\text{mm}$

Pour les applications au plafond, l'injection n'est possible qu'avec l'aide d'embout à injection et extension. Assembler la buse mélangeuse HIT-RE-M, les rallonges et l'embout pour injection de taille appropriée (voir le tableau B8 et le Tableau B9). Insérer l'embout à injection au fond du trou et commencer l'injection. Au cours de l'injection, l'embout sera naturellement repoussé par la pression de la résine vers le bord du trou.

Mise en place de l'élément d'ancrage

Avant de mettre en place l'élément d'ancrage le trou percé doit être débarrassé de toute poussière ou débris.

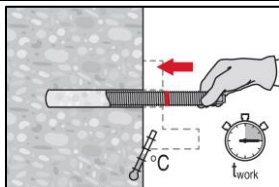

Avant utilisation, vérifier que les éléments sont secs et exempts d'huile, graisse et autres contaminants.

Marquer et insérer l'élément à la profondeur requise jusqu'à ce que la durée pratique d'utilisation t_{work} se soit écoulée. La durée pratique d'utilisation t_{work} est donnée dans le Tableau B7.

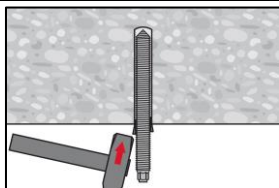

Pour les applications au plafond utiliser les embouts à injection et sécuriser les éléments, par exemple avec des coins.

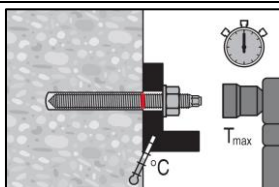

Mise en charge la cheville:

Après le temps de durcissement t_{cure} (voir Tableau B7) la fixation peut être mise en charge.

Le couple de serrage appliqué ne doit pas excéder les valeurs de max. T_{inst} données dans le tableau B1 au Tableau B5.

Injection system Hilti HIT-RE 500 V4

Mode d'emploi
Instructions d'installation

Annexe B14

Installation du Filling Set

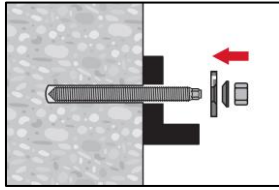

Utiliser le Hilti filling set avec un écrou standard. Une orientation correcte de la rondelle de remplissage et de la rondelle sphérique doit être respectée.

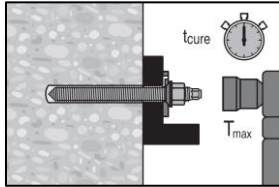

Le couple d'installation appliqué ne doit pas dépasser les valeurs de max. T_{max} données dans le Tableau B1 au Tableau B5.

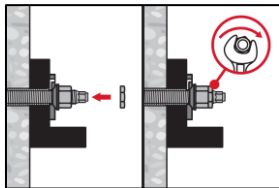

Optionnel :
Installation d'un contre écrou. Serrer de $\frac{1}{4}$ à $\frac{1}{2}$ tour. (Non valable pour la taille M24.)

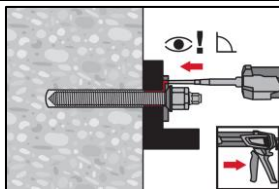

Remplir l'espace annulaire entre la tige filetée et la pièce à fixer en injectant 1 à 3 fois de la résine Hilti HIT-HY ... ou HIT-RE
Suivre les instructions d'installation fournies avec sur la cartouche de résine Hilti.
Après le temps de durcissement requis t_{cure} la fixation peut être chargée.

Injection system Hilti HIT-RE 500 V4

Mode d'emploi
Instructions d'installation

Annexe B15

Tableau C1: Caractéristiques essentielles des tiges filetées métriques selon l'Annexe A sous charge de traction dans le béton

Tiges filetées métriques selon l'Annexe A			M8	M10	M12	M16	M20	M24	M27	M30		
Pour une durée de vie de 50 et 100 ans												
Rupture acier												
Résistance caractéristique	$N_{Rk,s}$	[kN]	$A_s \cdot f_{uk}$									
Facteur partiel classe 5.8, 6.8, 8.8 (Tableau A2)	$\gamma_{Ms,N}^{1)}$	[-]	1,5									
Coefficient partiel HAS A4, HAS-U A4, HIT-V-R, Tiges filetées: CRC II et III (Tableau A2)	$\gamma_{Ms,N}^{1)}$	[-]	1,87						2,86			
Coefficient partiel HAS-U HCR, HIT-V-HCR Tiges filetées: CRC V (Tableau A2)	$\gamma_{Ms,N}^{1)}$	[-]	1,5					2,1				
Facteur d'installation												
Perçage par percussion	γ_{inst}	[-]	1,0									
Perçage par percussion avec foret aspirant Hilti TE-CD ou TE-YD	γ_{inst}	[-]	1,0									
Carottage diamant	γ_{inst}	[-]	1,2				1,4					
Carottage diamant avec abrasion avec le Hilti TE-YRT	γ_{inst}	[-]	2)				1,0					
Perçage par percussion en trous inondés	γ_{inst}	[-]	1,4									
Rupture par cône béton												
Facteur pour le béton fissuré	$k_{Cr,N}$	[-]	7,7									
Facteur pour le béton non fissuré	$k_{Ucr,N}$	[-]	11,0									
Distance du bord	$C_{Cr,N}$	[mm]	$1,5 \cdot h_{ef}$									
Entraxe	$S_{Cr,N}$	[mm]	$3,0 \cdot h_{ef}$									
Rupture par fendage												
Distance du bord $C_{Cr,sp}$ [mm] pour	$h / h_{ef} \geq 2,0$		$1,0 \cdot h_{ef}$									
	$2,0 > h / h_{ef} > 1,3$		$4,6 \cdot h_{ef} - 1,8 \cdot h$									
	$h / h_{ef} \leq 1,3$		$2,26 \cdot h_{ef}$									
Entraxe	$S_{Cr,sp}$	[mm]	$2 \cdot C_{Cr,sp}$									

Injection system Hilti HIT-RE 500 V4

Performances

Caractéristiques essentielles sous charge de traction dans le béton

Annexe C1

Tableau C1: suite

Tiges filetées métriques selon l'Annexe A				M8	M10	M12	M16	M20	M24	M27	M30
Rupture mixte par extraction et par cône béton pour une durée de vie de 50 ans											
Résistance caractéristique dans du béton non fissuré C20/25 dans des trous percés par percussion et dans des trous percés par percussion avec le foret aspirant TE-CD ou TE-YD et dans des trous percés par carottage diamant avec utilisation de l'outil abrasif Hilti TE-YRT											
Classe de température I:	40°C/24°C	$\tau_{Rk,ucr}$ [N/mm ²]		19	18	18	17	16	15	15	14
Classe de température II:	55°C/43°C	$\tau_{Rk,ucr}$ [N/mm ²]		16	15	15	14	13	13	12	12
Classe de température III:	75°C/55°C	$\tau_{Rk,ucr}$ [N/mm ²]		6,0	6,0	6,0	5,5	5,0	5,0	4,5	4,5
Résistance caractéristique dans du béton non fissuré C20/25 dans des trous percés par carottage diamant											
Classe de température I:	40°C/24°C	$\tau_{Rk,ucr}$ [N/mm ²]		13	13	13	13	12	12	12	12
Classe de température II:	55°C/43°C	$\tau_{Rk,ucr}$ [N/mm ²]		12	12	11	11	11	11	11	10
Classe de température III:	75°C/55°C	$\tau_{Rk,ucr}$ [N/mm ²]		6,0	5,5	5,5	5,5	5,5	5,5	5,5	5,0
Résistance caractéristique dans du béton non fissuré C20/25 dans des trous percés par percussion et installation dans des trous remplis d'eau											
Classe de température I:	40°C/24°C	$\tau_{Rk,ucr}$ [N/mm ²]		16	16	15	15	14	13	12	12
Classe de température II:	55°C/43°C	$\tau_{Rk,ucr}$ [N/mm ²]		13	13	13	12	11	11	10	10
Classe de température III:	75°C/55°C	$\tau_{Rk,ucr}$ [N/mm ²]		5,0	5,0	5,0	4,5	4,5	4,0	4,0	4,0
Résistance caractéristique dans du béton fissuré C20/25 dans des trous percés par percussion et dans des trous percés par percussion avec le foret aspirant TE-CD ou TE-YD et dans des trous percés par carottage diamant avec utilisation de l'outil abrasif Hilti TE-YRT											
Classe de température I:	40°C/24°C	$\tau_{Rk,ucr}$ [N/mm ²]		7,5	9,0	11	11	10	9,5	9,0	8,5
Classe de température II:	55°C/43°C	$\tau_{Rk,ucr}$ [N/mm ²]		7,0	8,0	9,0	8,5	8,0	8,0	7,5	7,0
Classe de température III:	75°C/55°C	$\tau_{Rk,ucr}$ [N/mm ²]		4,0	3,5	3,5	3,5	3,0	3,0	3,0	3,0
Influence des facteurs ψ sur la contrainte d'adhérence τ_{Rk} dans du béton fissuré et non fissuré											
Influence de la résistance du béton											
dans des trous percés par percussion et dans des trous percés par percussion avec le foret aspirant TE-CD ou TE-YD et dans des trous percés par carottage diamant											
Classe de température I à III		ψ_c [-]		$(f_{ck}/20)^{0,1}$							
dans des trous percés par carottage diamant avec utilisation de l'outil abrasif Hilti TE-YRT											
Classe de température I à III:		ψ_c [-]		2)				1,0			
Influence de la charge permanente											
dans des trous percés par percussion et dans des trous percés par percussion avec le foret aspirant TE-CD ou TE-YD et dans des trous percés par carottage diamant avec utilisation de l'outil abrasif Hilti TE-YRT											
Classe de température I:	40°C / 24°C	ψ_{sus}^0 [-]		0,88							
Classe de température II:	55°C / 43°C	ψ_{sus}^0 [-]		0,72							
Classe de température III:	75°C / 55°C	ψ_{sus}^0 [-]		0,69							
dans des trous percés par carottage diamant											
Classe de température I:	40°C / 24°C	ψ_{sus}^0 [-]		0,89							
Classe de température II:	55°C / 43°C	ψ_{sus}^0 [-]		0,70							
Classe de température III:	75°C / 55°C	ψ_{sus}^0 [-]		0,62							

Injection system Hilti HIT-RE 500 V4

Performances

Caractéristiques essentielles sous charge de traction dans le béton

Annexe C2

Tableau C1: suite (2)

Tiges filetées métriques selon l'Annexe A	M8	M10	M12	M16	M20	M24	M27	M30
Rupture mixte par extraction et par cône béton pour une durée de vie de 100 ans								
Résistance caractéristique dans du béton non fissuré C20/25 dans des trous percés par percussion et dans des trous percés par percussion avec le foret aspirant TE-CD ou TE-YD et dans des trous percés par carottage diamant avec utilisation de l'outil abrasif Hilti TE-YRT								
Classe de température I: 40°C/24°C $\tau_{Rk,ucr}$ [N/mm ²]	19	18	18	17	16	15	15	14
Classe de température II: 55°C/43°C $\tau_{Rk,ucr}$ [N/mm ²]	15	15	15	14	13	13	12	11
Classe de température III: 75°C/55°C $\tau_{Rk,ucr}$ [N/mm ²]	6,0	6,0	6,0	5,5	5,0	5,0	4,5	4,5
Résistance caractéristique dans du béton non fissuré C20/25 dans des trous percés par carottage diamant								
Classe de température I: 40°C/24°C $\tau_{Rk,100,ucr}$ [N/mm ²]	13	13	13	13	12	12	12	12
Classe de température II: 55°C/43°C $\tau_{Rk,100,ucr}$ [N/mm ²]	12	12	11	11	11	11	11	10
Classe de température III: 75°C/55°C $\tau_{Rk,100,ucr}$ [N/mm ²]	6,0	5,5	5,5	5,5	5,5	5,5	5,5	5,0
Résistance caractéristique dans du béton non fissuré C20/25 dans des trous percés par percussion et installation dans des trous remplis d'eau								
Classe de température I: 40°C/24°C $\tau_{Rk,100,ucr}$ [N/mm ²]	16	16	15	15	14	13	12	12
Classe de température II: 55°C/43°C $\tau_{Rk,100,ucr}$ [N/mm ²]	13	13	13	12	11	11	10	9,5
Classe de température III: 75°C/55°C $\tau_{Rk,100,ucr}$ [N/mm ²]	5,0	5,0	5,0	4,5	4,5	4,0	4,0	4,0
Résistance caractéristique dans du béton fissuré C20/25 dans des trous percés par percussion et dans des trous percés par percussion avec le foret aspirant TE-CD ou TE-YD et dans des trous percés par carottage diamant avec utilisation de l'outil abrasif Hilti TE-YRT								
Classe de température I: 40°C/24°C $\tau_{Rk,100,cr}$ [N/mm ²]	7,0	8,0	9,0	8,5	8,0	7,5	7,0	6,5
Classe de température II: 55°C/43°C $\tau_{Rk,100,cr}$ [N/mm ²]	6,0	7,0	8,0	7,5	7,0	6,5	6,5	6,0
Classe de température III: 75°C/55°C $\tau_{Rk,100,cr}$ [N/mm ²]	4,0	3,5	3,5	3,5	3,0	3,0	3,0	3,0
Influence des facteurs ψ sur la contrainte d'adhérence τ_{Rk} dans du béton fissuré et non fissuré								
Influence de la résistance du béton								
dans des trous percés par percussion et dans des trous percés par percussion avec le foret aspirant TE-CD ou TE-YD et dans des trous percés par carottage diamant								
Classe de température I à III ψ_c [-]	$(f_{ck}/20)^{0,1}$							
dans des trous percés par carottage diamant avec utilisation de l'outil abrasif Hilti TE-YRT								
Classe de température I à III: ψ_c [-]	2)				1,0			
Influence de la charge permanente								
dans des trous percés par percussion et dans des trous percés par percussion avec le foret aspirant TE-CD ou TE-YD et dans des trous percés par carottage diamant avec utilisation de l'outil abrasif Hilti TE-YRT								
Classe de température I: 40°C/24°C $\psi^0_{sus,100}$ [-]	0,85							
Classe de température II: 55°C/43°C $\psi^0_{sus,100}$ [-]	0,72							
Classe de température III: 75°C/55°C $\psi^0_{sus,100}$ [-]	0,69							
dans des trous percés par carottage diamant								
Classe de température I: 40°C/24°C $\psi^0_{sus,100}$ [-]	0,70							
Classe de température II: 55°C/43°C $\psi^0_{sus,100}$ [-]	0,67							
Classe de température III: 75°C/55°C $\psi^0_{sus,100}$ [-]	0,62							

1) En l'absence de réglementation nationale.

2) Performances non évaluées.

Injection system Hilti HIT-RE 500 V4

Performances

Caractéristiques essentielles sous charge de traction dans le béton

Annexe C3

Tableau C2: Caractéristiques essentielles des tiges filetées impériales selon l'Annexe A sous charge de traction dans le béton

Tiges filetées impériales selon l'Annexe A		[in.]	3/8	1/2	5/8	3/4	7/8	1	1 1/4
Pour une durée de vie de 50 et 100 ans									
Rupture de l'acier									
Résistance caractéristique	$N_{Rk,s}$	[kN]	$A_s \cdot f_{uk}$						
Facteur partiel HIT-V	$\gamma_{Ms,N}^{1)}$	[-]	1,92						
Facteur partiel HAS-V-36	$\gamma_{Ms,N}^{1)}$	[-]	1,94						
Facteur partiel HAS-E-55	$\gamma_{Ms,N}^{1)}$	[-]	1,64						
Facteur partiel HAS-B-105	$\gamma_{Ms,N}^{1)}$	[-]	1,43						
Facteur partiel HAS-R 304	$\gamma_{Ms,N}^{1)}$	[-]	1,85		2,27			3,01	
Facteur partiel HAS-R 316	$\gamma_{Ms,N}^{1)}$	[-]	1,85		2,27				
Coefficient de sécurité d'installation									
Perçage par percussion	γ_{inst}	[-]	1,0						
Perçage par percussion avec le foret aspirant TE-CD ou TE-YD	γ_{inst}	[-]	2)	1,0					
Perçage par carottage diamant	γ_{inst}	[-]	1,2		1,4				
Perçage par carottage diamant et utilisation de l'outil abrasif Hilti TE-YRT	γ_{inst}	[-]	2)	1,0					
Perçage par percussion et installation dans des trous remplis d'eau	γ_{inst}	[-]	1,4						
Rupture par cône béton									
Facteur pour le béton fissuré	$k_{cr,N}$	[-]	7,7						
Facteur pour le béton non fissuré	$k_{ucr,N}$	[-]	11,0						
Distance au bord	$c_{cr,N}$	[mm]	$1,5 \cdot h_{ef}$						
Entre-axe	$s_{cr,N}$	[mm]	$3,0 \cdot h_{ef}$						
Rupture par fendage									
Distance au bord $c_{cr,sp}$ [mm] pour	$h / h_{ef} \geq 2,0$		$1,0 \cdot h_{ef}$						
	$2,0 > h / h_{ef} > 1,3$		$4,6 \cdot h_{ef} - 1,8 \cdot h$						
	$h / h_{ef} \leq 1,3$		$2,26 \cdot h_{ef}$						
Entre-axe	$s_{cr,sp}$	[mm]	$2 \cdot c_{cr,sp}$						

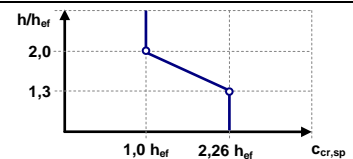

Injection system Hilti HIT-RE 500 V4

Performances

Caractéristiques essentielles sous charge de traction dans le béton

Annexe C4

Tableau C2: Suite (1)

Tiges filetées impériales selon l'Annexe A	[in.]	3/8	1/2	5/8	3/4	7/8	1	1 1/4	
Rupture mixte par extraction et par cône béton pour une durée de vie de 50 ans									
Résistance caractéristique dans du béton non fissuré C20/25 dans des trous percés par percussion et dans des trous percés par percussion avec le foret aspirant TE-CD ou TE-YD et dans des trous percés par carottage diamant avec utilisation de l'outil abrasif Hilti TE-YRT									
Classe de température I: 40°C/24°C	$\tau_{Rk,ucr}$	[N/mm ²]	19	18	17	16	16	15	14
Classe de température II: 55°C/43°C	$\tau_{Rk,ucr}$	[N/mm ²]	15	15	14	14	13	12	11
Classe de température III: 75°C/55°C	$\tau_{Rk,ucr}$	[N/mm ²]	6,0	6,0	5,5	5,5	5,0	5,0	4,5
Résistance caractéristique dans du béton non fissuré C20/25 dans des trous percés par carottage diamant									
Classe de température I: 40°C/24°C	$\tau_{Rk,ucr}$	[N/mm ²]	13	13	13	12	12	12	12
Classe de température II: 55°C/43°C	$\tau_{Rk,ucr}$	[N/mm ²]	12	11	11	11	11	11	10
Classe de température III: 75°C/55°C	$\tau_{Rk,ucr}$	[N/mm ²]	5,5	5,5	5,5	5,5	5,5	5,5	5,0
Résistance caractéristique dans du béton non fissuré C20/25 dans des trous percés par percussion et installation dans des trous remplis d'eau									
Classe de température I: 40°C/24°C	$\tau_{Rk,ucr}$	[N/mm ²]	16	15	15	14	13	13	12
Classe de température II: 55°C/43°C	$\tau_{Rk,ucr}$	[N/mm ²]	13	13	12	12	11	11	9,5
Classe de température III: 75°C/55°C	$\tau_{Rk,ucr}$	[N/mm ²]	5,0	5,0	4,5	4,5	4,5	4,0	3,5
Résistance caractéristique dans du béton fissuré C20/25 dans des trous percés par percussion et dans des trous percés par percussion avec le foret aspirant TE-CD ou TE-YD et dans des trous percés par carottage diamant avec utilisation de l'outil abrasif Hilti TE-YRT									
Classe de température I: 40°C/24°C	$\tau_{Rk,cr}$	[N/mm ²]	9,0	11	11	10	9,0	9,0	8,5
Classe de température II: 55°C/43°C	$\tau_{Rk,cr}$	[N/mm ²]	8,0	9,0	8,5	8,5	8,0	7,5	7,0
Classe de température III: 75°C/55°C	$\tau_{Rk,cr}$	[N/mm ²]	3,5	3,5	3,5	3,0	3,0	3,0	2,5
Influence des facteurs ψ sur la contrainte d'adhérence τ_{Rk} dans du béton fissuré et non fissuré									
Influence de la résistance du béton									
dans des trous percés par percussion et dans des trous percés par percussion avec le foret aspirant TE-CD ou TE-YD et dans des trous percés par carottage diamant									
Classe de température I à III:	ψ_c	[-]	$(f_{ck}/20)^{0,1}$						
dans des trous percés par carottage diamant avec utilisation de l'outil abrasif Hilti TE-YRT									
Classe de température I à III:	ψ_c	[-]	2)			1,0			
Influence de la charge permanente									
dans des trous percés par percussion et dans des trous percés par percussion avec le foret aspirant TE-CD ou TE-YD et dans des trous percés par carottage diamant avec utilisation de l'outil abrasif Hilti TE-YRT									
Classe de température I: 40°C/24°C	ψ^0_{sus}	[-]	0,88						
Classe de température II: 55°C/43°C	ψ^0_{sus}	[-]	0,72						
Classe de température III: 75°C/55°C	ψ^0_{sus}	[-]	0,69						
dans des trous percés par carottage diamant									
Classe de température I: 40°C/24°C	ψ^0_{sus}	[-]	0,89						
Classe de température II: 55°C/43°C	ψ^0_{sus}	[-]	0,70						
Classe de température III: 75°C/55°C	ψ^0_{sus}	[-]	0,62						

Injection system Hilti HIT-RE 500 V4

Performances

Caractéristiques essentielles sous charge de traction dans le béton

Annexe C5

Tableau C2: suite (2)

Tiges filetées impériales selon l'Annexe A	[in.]	3/8	1/2	5/8	3/4	7/8	1	1 1/4
Rupture mixte par extraction et par cône béton pour une durée de vie de 100 ans								
Résistance caractéristique dans du béton non fissuré C20/25 dans des trous percés par percussion et dans des trous percés par percussion avec le foret aspirant TE-CD ou TE-YD et dans des trous percés par carottage diamant avec utilisation de l'outil abrasif Hilti TE-YRT								
Classe de température I: 40°C/24°C	$\tau_{Rk,100,ucr}$ [N/mm ²]	19	18	17	16	16	15	14
Classe de température II: 55°C/43°C	$\tau_{Rk,100,ucr}$ [N/mm ²]	15	15	14	13	13	12	11
Classe de température III: 75°C/55°C	$\tau_{Rk,100,ucr}$ [N/mm ²]	6,0	6,0	5,5	5,5	5,0	5,0	4,5
Résistance caractéristique dans du béton non fissuré C20/25 dans des trous percés par carottage diamant								
Classe de température I: 40°C/24°C	$\tau_{Rk,100,ucr}$ [N/mm ²]	13	13	13	12	12	12	12
Classe de température II: 55°C/43°C	$\tau_{Rk,100,ucr}$ [N/mm ²]	12	11	11	11	11	11	10
Classe de température III: 75°C/55°C	$\tau_{Rk,100,ucr}$ [N/mm ²]	5,5	5,5	5,5	5,5	5,5	5,5	5,0
Résistance caractéristique dans du béton non fissuré C20/25 dans des trous percés par percussion et installation dans des trous remplis d'eau								
Classe de température I: 40°C/24°C	$\tau_{Rk,100,ucr}$ [N/mm ²]	16	15	15	14	13	13	12
Classe de température II: 55°C/43°C	$\tau_{Rk,100,ucr}$ [N/mm ²]	13	12	12	11	11	10	9,5
Classe de température III: 75°C/55°C	$\tau_{Rk,100,ucr}$ [N/mm ²]	5,0	5,0	4,5	4,5	4,5	4,0	3,5
Résistance caractéristique dans du béton fissuré C20/25 dans des trous percés par percussion et dans des trous percés par percussion avec le foret aspirant TE-CD ou TE-YD et dans des trous percés par carottage diamant avec utilisation de l'outil abrasif Hilti TE-YRT								
Classe de température I: 40°C/24°C	$\tau_{Rk,100,cr}$ [N/mm ²]	8,0	8,5	8,5	8,0	7,5	7,5	6,5
Classe de température II: 55°C/43°C	$\tau_{Rk,100,cr}$ [N/mm ²]	7,0	7,5	7,5	7,0	7,0	6,5	6,0
Classe de température III: 75°C/55°C	$\tau_{Rk,100,cr}$ [N/mm ²]	3,5	3,5	3,5	3,0	3,0	3,0	2,5
Influence des facteurs ψ sur la contrainte d'adhérence τ_{Rk} dans du béton fissuré et non fissuré								
Influence de la résistance du béton								
dans des trous percés par percussion et dans des trous percés par percussion avec le foret aspirant TE-CD ou TE-YD et dans des trous percés par carottage diamant								
Classe de température I à III:	ψ_c [-]	$(f_{ck}/20)^{0,1}$						
dans des trous percés par carottage diamant avec utilisation de l'outil abrasif Hilti TE-YRT								
Classe de température I à III:	ψ_c [-]	2)			1,0			
Influence de la charge permanente								
dans des trous percés par percussion et dans des trous percés par percussion avec le foret aspirant TE-CD ou TE-YD et dans des trous percés par carottage diamant avec utilisation de l'outil abrasif Hilti TE-YRT								
Classe de température I: 40°C/24°C	$\psi_{sus,100}^0$ [-]	0,85						
Classe de température II: 55°C/43°C	$\psi_{sus,100}^0$ [-]	0,72						
Classe de température III: 75°C/55°C	$\psi_{sus,100}^0$ [-]	0,69						
dans des trous percés par carottage diamant								
Classe de température I: 40°C/24°C	$\psi_{sus,100}^0$ [-]	0,70						
Classe de température II: 55°C/43°C	$\psi_{sus,100}^0$ [-]	0,67						
Classe de température III: 75°C/55°C	$\psi_{sus,100}^0$ [-]	0,62						

1) En l'absence de réglementation nationale.

2) Performances non évaluées.

Injection system Hilti HIT-RE 500 V4

Performances

Caractéristiques essentielles sous efforts de traction dans le béton

Annexe C6

Tableau C3: Caractéristiques essentielles des douilles taraudées HIS-(R)N sous charge de traction dans le béton

HIS-(R)N			M8	M10	M12	M16	M20
Diamètre extérieur de la gaine	d_{nom}	[mm]	12,5	16,5	20,5	25,4	27,6
Rupture acier							
Résistance caractéristique HIS-N avec une vis de classe 8.8	$N_{Rk,s}$	[kN]	25	46	67	125	116
Coefficient partiel	$\gamma_{Ms,N}$	[-]	1,5				
Résistance caractéristique HIS-RN avec une vis de classe 70	$N_{Rk,s}$	[kN]	26	41	59	110	166
Coefficient partiel	$\gamma_{Ms,N}$	[-]	1,87				2,4
Facteur d'installation							
Perçage par percussion	γ_{inst}	[-]	1,0				
Perçage par percussion avec foret aspirant Hilti TE-CD ou TE-YD	γ_{inst}	[-]	1,0				
Carottage diamant	γ_{inst}	[-]	1,2	1,4			
Carottage diamant et abrasion avec l'outil Hilti TE-YRT	γ_{inst}	[-]	2)	1,0			
Perçage par percussion dans des trous inondés	γ_{inst}	[-]	1,4				
Rupture par cône béton							
Facteur pour le béton fissuré	$k_{Cr,N}$	[-]	7,7				
Facteur pour le béton non fissuré	$k_{ucr,N}$	[-]	11,0				
Distance du bord	$c_{Cr,N}$	[mm]	$1,5 \cdot h_{ef}$				
Entraxe	$s_{Cr,N}$	[mm]	$3,0 \cdot h_{ef}$				
Rupture par fendage							
Distance du bord $c_{Cr,sp}$ [mm] pour	$h / h_{ef} \geq 2,0$		$1,0 \cdot h_{ef}$				
	$2,0 > h / h_{ef} > 1,3$		$4,6 \cdot h_{ef} - 1,8 \cdot h$				
	$h / h_{ef} \leq 1,3$		$2,26 \cdot h_{ef}$				
Entraxe	$s_{Cr,sp}$	[mm]	$2 \cdot c_{Cr,sp}$				

Injection system Hilti HIT-RE 500 V4

Performances

Caractéristiques essentielles sous efforts de traction dans le béton

Annexe C7

Tableau C3: suite (1)

HIS-(R)N	M8	M10	M12	M16	M20
Diamètre extérieur de la gaine d_{nom} [mm]	12,5	16,5	20,5	25,4	27,6
Rupture mixte par extraction et par cône béton pour une durée de vie de 50 ans					
Résistance caractéristique dans du béton non fissuré C20/25 dans des trous percés par percussion et dans des trous percés par percussion avec le foret aspirant TE-CD ou TE-YD et dans des trous percés par carottage diamant avec utilisation de l'outil abrasif Hilti TE-YRT					
Classe de température I: 40°C/24°C $\tau_{RK,ucr}$ [N/mm ²]	14	14	14	14	14
Classe de température II: 55°C/43°C $\tau_{RK,ucr}$ [N/mm ²]	12	12	12	12	12
Classe de température III: 75°C/55°C $\tau_{RK,ucr}$ [N/mm ²]	4,5	4,5	4,5	4,5	4,5
Résistance caractéristique dans du béton non fissuré C20/25 dans des trous percés par carottage diamant					
Classe de température I: 40°C/24°C $\tau_{RK,ucr}$ [N/mm ²]	8,5	9,0	9,5	10	10
Classe de température II: 55°C/43°C $\tau_{RK,ucr}$ [N/mm ²]	8,0	8,0	8,5	9,0	9,0
Classe de température III: 75°C/55°C $\tau_{RK,ucr}$ [N/mm ²]	4,0	4,0	4,0	4,5	4,5
Résistance caractéristique dans du béton non fissuré C20/25 dans des trous percés par percussion et installation dans des trous remplis d'eau					
Classe de température I: 40°C/24°C $\tau_{RK,ucr}$ [N/mm ²]	12	12	12	12	12
Classe de température II: 55°C/43°C $\tau_{RK,ucr}$ [N/mm ²]	10	10	10	10	10
Classe de température III: 75°C/55°C $\tau_{RK,ucr}$ [N/mm ²]	4,0	4,0	4,0	4,0	4,0
Résistance caractéristique dans du béton fissuré C20/25 dans des trous percés par percussion et dans des trous percés par percussion avec le foret aspirant TE-CD ou TE-YD et dans des trous percés par carottage diamant avec utilisation de l'outil abrasif Hilti TE-YRT					
Classe de température I: 40°C/24°C $\tau_{RK,cr}$ [N/mm ²]	9,0	9,0	9,0	9,0	9,0
Classe de température II: 55°C/43°C $\tau_{RK,cr}$ [N/mm ²]	8,0	8,0	8,0	8,0	8,0
Classe de température III: 75°C/55°C $\tau_{RK,cr}$ [N/mm ²]	3,0	3,0	3,0	3,0	3,0
Influence des facteurs ψ sur la contrainte d'adhérence τ_{RK} dans du béton fissuré et non fissuré					
Influence de la résistance du béton					
dans des trous percés par percussion et dans des trous percés par percussion avec le foret aspirant TE-CD ou TE-YD et dans des trous percés par carottage diamant					
Classe de température I à III: ψ_c [-]	$(f_{ck}/20)^{0,1}$				
dans des trous percés par carottage diamant avec utilisation de l'outil abrasif Hilti TE-YRT					
Classe de température I à III: ψ_c [-]	2)		1,0		
Influence de la charge permanente					
dans des trous percés par percussion et dans des trous percés par percussion avec le foret aspirant TE-CD ou TE-YD et dans des trous percés par carottage diamant avec utilisation de l'outil abrasif Hilti TE-YRT					
Classe de température I: 40°C/24°C $\psi^{0_{sus}}$ [-]	0,88				
Classe de température II: 55°C/43°C $\psi^{0_{sus}}$ [-]	0,72				
Classe de température III: 75°C/55°C $\psi^{0_{sus}}$ [-]	0,69				
dans des trous percés par carottage diamant					
Classe de température I: 40°C/24°C $\psi^{0_{sus}}$ [-]	0,89				
Classe de température II: 55°C/43°C $\psi^{0_{sus}}$ [-]	0,70				
Classe de température III: 75°C/55°C $\psi^{0_{sus}}$ [-]	0,62				

Injection system Hilti HIT-RE 500 V4

Performances

Caractéristiques essentielles sous efforts de traction dans le béton

Annexe C8

Tableau C3: suite (2)

HIS-(R)N	M8	M10	M12	M16	M20
Diamètre extérieur de la gaine d_{nom} [mm]	12,5	16,5	20,5	25,4	27,6
Rupture mixte par extraction et par cône béton pour une durée de vie de 100 ans					
Résistance caractéristique dans du béton non fissuré C20/25 dans des trous percés par percussion et dans des trous percés par percussion avec le foret aspirant TE-CD ou TE-YD et dans des trous percés par carottage diamant avec utilisation de l'outil abrasif Hilti TE-YRT					
Classe de température I: 40°C/24°C $\tau_{Rk,100,ucr}$ [N/mm ²]	14	14	14	14	14
Classe de température II: 55°C/43°C $\tau_{Rk,100,ucr}$ [N/mm ²]	11	11	11	11	11
Classe de température III: 75°C/55°C $\tau_{Rk,100,ucr}$ [N/mm ²]	4,5	4,5	4,5	4,5	4,5
Résistance caractéristique dans du béton non fissuré C20/25 dans des trous percés par carottage diamant					
Classe de température I: 40°C/24°C $\tau_{Rk,100,ucr}$ [N/mm ²]	8,5	9,0	9,5	10	10
Classe de température II: 55°C/43°C $\tau_{Rk,100,ucr}$ [N/mm ²]	8,0	8,0	8,5	9,0	9,0
Classe de température III: 75°C/55°C $\tau_{Rk,100,ucr}$ [N/mm ²]	4,0	4,0	4,0	4,5	4,5
Résistance caractéristique dans du béton non fissuré C20/25 dans des trous percés par percussion et installation dans des trous remplis d'eau					
Classe de température I: 40°C/24°C $\tau_{Rk,100,ucr}$ [N/mm ²]	12	12	12	12	12
Classe de température II: 55°C/43°C $\tau_{Rk,100,ucr}$ [N/mm ²]	9,5	9,5	9,5	9,5	9,5
Classe de température III: 75°C/55°C $\tau_{Rk,100,ucr}$ [N/mm ²]	4,0	4,0	4,0	4,0	4,0
Résistance caractéristique dans du béton fissuré C20/25 dans des trous percés par percussion et dans des trous percés par percussion avec le foret aspirant TE-CD ou TE-YD et dans des trous percés par carottage diamant avec utilisation de l'outil abrasif Hilti TE-YRT					
Classe de température I: 40°C/24°C $\tau_{Rk,100,cr}$ [N/mm ²]	7,0	7,0	7,0	7,0	7,0
Classe de température II: 55°C/43°C $\tau_{Rk,100,cr}$ [N/mm ²]	6,0	6,5	6,5	6,5	6,5
Classe de température III: 75°C/55°C $\tau_{Rk,100,cr}$ [N/mm ²]	3,0	3,0	3,0	3,0	3,0
Influence des facteurs ψ sur la contrainte d'adhérence τ_{RK} dans du béton fissuré et non fissuré					
Influence de la résistance du béton					
dans des trous percés par percussion et dans des trous percés par percussion avec le foret aspirant TE-CD ou TE-YD et dans des trous percés par carottage diamant					
Classe de température I à III: ψ_c [-]	$(f_{ck}/20)^{0,1}$				
dans des trous percés par carottage diamant avec utilisation de l'outil abrasif Hilti TE-YRT					
Classe de température I à III: ψ_c [-]	2)		1,0		
Influence de la charge permanente					
dans des trous percés par percussion et dans des trous percés par percussion avec le foret aspirant TE-CD ou TE-YD et dans des trous percés par carottage diamant avec utilisation de l'outil abrasif Hilti TE-YRT					
Classe de température I: 40°C/24°C $\psi_{sus,100}^0$ [-]	0,85				
Classe de température II: 55°C/43°C $\psi_{sus,100}^0$ [-]	0,72				
Classe de température III: 75°C/55°C $\psi_{sus,100}^0$ [-]	0,69				
dans des trous percés par carottage diamant					
Classe de température I: 40°C/24°C $\psi_{sus,100}^0$ [-]	0,70				
Classe de température II: 55°C/43°C $\psi_{sus,100}^0$ [-]	0,67				
Classe de température III: 75°C/55°C $\psi_{sus,100}^0$ [-]	0,62				

1) En l'absence de réglementation nationale
2) Performance non évaluée.

Injection system Hilti HIT-RE 500 V4

Performances

Caractéristiques essentielles sous efforts de traction dans le béton

Annexe C9

Tableau C4: Caractéristiques essentielles des douilles taraudées HIS-(R)N sous charge de traction dans le béton

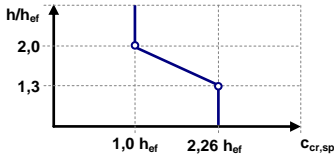
HIS-(R)N, taille		[in.]	3/8	1/2	5/8	3/4
Diamètre extérieur de la gaine	d_{nom}	[mm]	16,5	20,5	25,4	27,6
Rupture acier						
Résistance caractéristique HIS-N Vis selon la SAE J429 Classe 5 ou ASTM A325 (1/2 in. à 3/4 in.)	$N_{Rk,s}$	[kN]	41	76	121	130
Coefficient partiel	$\gamma_{Ms,N}^{1)}$	[-]	1,57			1,50
Résistance caractéristique HIS-N Vis selon l'ASTM A193 Classe B7	$N_{Rk,s}$	[kN]	43	77	128	130
Coefficient partiel	$\gamma_{Ms,N}^{1)}$	[-]	1,43	1,50		
Résistance caractéristique HIS-N Vis selon l'ASTM A193 Classe B8M	$N_{Rk,s}$	[kN]	38	110	182	185
Coefficient partiel	$\gamma_{Ms,N}^{1)}$	[-]	1,40	2,40		
Résistance caractéristique HIS-N Vis selon l'ASTM A193 Classe B8T	$N_{Rk,s}$	[kN]	43	110	182	185
Coefficient partiel	$\gamma_{Ms,N}^{1)}$	[-]	1,50	2,40		
Facteur d'installation						
Perçage par percussion	γ_{inst}	[-]	1,0			
Perçage par percussion avec foret aspirant Hilti TE-CD ou TE-YD	γ_{inst}	[-]	3)	1,0		3)
Carottage diamant	γ_{inst}	[-]	1,4			
Carottage diamant et abrasion avec l'outil Hilti TE-YRT	γ_{inst}	[-]	3)	1,0		3)
Perçage par percussion dans des trous inondés	γ_{inst}	[-]	1,4			
Rupture par cône béton						
Facteur pour le béton fissuré	$k_{Cr,N}$	[-]	7,7			
Facteur pour le béton non fissuré	$k_{Ucr,N}$	[-]	11,0			
Distance du bord	$c_{Cr,N}$	[mm]	$1,5 \cdot h_{ef}$			
Entraxe	$s_{Cr,N}$	[mm]	$3,0 \cdot h_{ef}$			
Rupture par fendage						
Distance du bord $c_{Cr,sp}$ [mm] pour	$h / h_{ef} \geq 2,0$		$1,0 \cdot h_{ef}$			
	$2,0 > h / h_{ef} > 1,3$		$4,6 \cdot h_{ef} - 1,8 \cdot h$			
	$h / h_{ef} \leq 1,3$		$2,26 \cdot h_{ef}$			
Entraxe	$s_{Cr,sp}$	[mm]	$2 \cdot c_{Cr,sp}$			

Injection system Hilti HIT-RE 500 V4

Performances

Caractéristiques essentielles sous efforts de traction dans le béton

Annexe C10

Tableau C4: Suite (1)

HIS-(R)N, size	[in.]	3/8	1/2	5/8	3/4
Diamètre extérieur de la gaine	d_{nom} [mm]	16,5	20,5	25,4	27,6
Rupture mixte par extraction et par cône béton pour une durée de vie de 50 ans					
Résistance caractéristique dans du béton non fissuré C20/25 dans des trous percés par percussion et dans des trous percés par percussion avec le foret aspirant TE-CD ou TE-YD et dans des trous percés par carottage diamant avec utilisation de l'outil abrasif Hilti TE-YRT					
Classe de température I:	40°C/24°C $\tau_{RK,ucr}$ [N/mm ²]	14	14	14	14
Classe de température II:	55°C/43°C $\tau_{RK,ucr}$ [N/mm ²]	12	12	12	12
Classe de température III:	75°C/55°C $\tau_{RK,ucr}$ [N/mm ²]	4,5	4,5	4,5	4,5
Résistance caractéristique dans du béton non fissuré C20/25 dans des trous percés par carottage diamant					
Classe de température I:	40°C/24°C $\tau_{RK,ucr}$ [N/mm ²]	9,0	9,5	10	10
Classe de température II:	55°C/43°C $\tau_{RK,ucr}$ [N/mm ²]	8,0	8,5	9,0	9,0
Classe de température III:	75°C/55°C $\tau_{RK,ucr}$ [N/mm ²]	4,0	4,0	4,5	4,5
Résistance caractéristique dans du béton non fissuré C20/25 dans des trous percés par percussion et installation dans des trous remplis d'eau					
Classe de température I:	40°C/24°C $\tau_{RK,ucr}$ [N/mm ²]	12	12	12	12
Classe de température II:	55°C/43°C $\tau_{RK,ucr}$ [N/mm ²]	10	10	10	10
Classe de température III:	75°C/55°C $\tau_{RK,ucr}$ [N/mm ²]	4,0	4,0	4,0	4,0
Résistance caractéristique dans du béton fissuré C20/25 dans des trous percés par percussion et dans des trous percés par percussion avec le foret aspirant TE-CD ou TE-YD et dans des trous percés par carottage diamant avec utilisation de l'outil abrasif Hilti TE-YRT					
Classe de température I:	40°C/24°C $\tau_{RK,cr}$ [N/mm ²]	9,0	9,0	9,0	9,0
Classe de température II:	55°C/43°C $\tau_{RK,cr}$ [N/mm ²]	8,0	8,0	8,0	8,0
Classe de température III:	75°C/55°C $\tau_{RK,cr}$ [N/mm ²]	3,0	3,0	3,0	3,0
Influence des facteurs ψ sur la contrainte d'adhérence τ_{RK} dans du béton fissuré et non fissuré					
Influence de la résistance du béton					
dans des trous percés par percussion et dans des trous percés par percussion avec le foret aspirant TE-CD ou TE-YD et dans des trous percés par carottage diamant					
Classe de température I à III:	ψ_c [-]	$(f_{ck}/20)^{0,1}$			
dans des trous percés par carottage diamant avec utilisation de l'outil abrasif Hilti TE-YRT					
Classe de température I à III:	ψ_c [-]	2)	1,0	2)	
Influence de la charge permanente					
dans des trous percés par percussion et dans des trous percés par percussion avec le foret aspirant TE-CD ou TE-YD et dans des trous percés par carottage diamant avec utilisation de l'outil abrasif Hilti TE-YRT					
Classe de température I:	40°C/24°C ψ_{sus}^0 [-]	0,88			
Classe de température II:	55°C/43°C ψ_{sus}^0 [-]	0,72			
Classe de température III:	75°C/55°C ψ_{sus}^0 [-]	0,69			
dans des trous percés par carottage diamant					
Classe de température I:	40°C/24°C ψ_{sus}^0 [-]	0,89			
Classe de température II:	55°C/43°C ψ_{sus}^0 [-]	0,70			
Classe de température III:	75°C/55°C ψ_{sus}^0 [-]	0,62			

Injection system Hilti HIT-RE 500 V4

Performances

Caractéristiques essentielles sous efforts de traction dans le béton

Annexe C11

Tableau C4: Suite (2)

HIS-(R)N, size	[in.]	3/8	1/2	5/8	3/4
Diamètre extérieur de la gaine	d _{nom} [mm]	16,5	20,5	25,4	27,6
Rupture mixte par extraction et par cône béton pour une durée de vie de 100 ans					
Résistance caractéristique dans du béton non fissuré C20/25 dans des trous percés par percussion et dans des trous percés par percussion avec le foret aspirant TE-CD ou TE-YD et dans des trous percés par carottage diamant avec utilisation de l'outil abrasif Hilti TE-YRT					
Classe de température I: 40°C/24°C	$\tau_{Rk,100,ucr}$ [N/mm ²]	14	14	14	14
Classe de température II: 55°C/43°C	$\tau_{Rk,100,ucr}$ [N/mm ²]	11	11	11	11
Classe de température III: 75°C/55°C	$\tau_{Rk,100,ucr}$ [N/mm ²]	4,5	4,5	4,5	4,5
Résistance caractéristique dans du béton non fissuré C20/25 dans des trous percés par carottage diamant					
Classe de température I: 40°C/24°C	$\tau_{Rk,100,ucr}$ [N/mm ²]	9,0	9,5	10	10
Classe de température II: 55°C/43°C	$\tau_{Rk,100,ucr}$ [N/mm ²]	8,0	8,5	9,0	9,0
Classe de température III: 75°C/55°C	$\tau_{Rk,100,ucr}$ [N/mm ²]	4,0	4,0	4,5	4,5
Résistance caractéristique dans du béton non fissuré C20/25 dans des trous percés par percussion et installation dans des trous remplis d'eau					
Classe de température I: 40°C/24°C	$\tau_{Rk,100,ucr}$ [N/mm ²]	12	12	12	12
Classe de température II: 55°C/43°C	$\tau_{Rk,100,ucr}$ [N/mm ²]	9,5	9,5	9,5	9,5
Classe de température III: 75°C/55°C	$\tau_{Rk,100,ucr}$ [N/mm ²]	4,0	4,0	4,0	4,0
Résistance caractéristique dans du béton fissuré C20/25 dans des trous percés par percussion et dans des trous percés par percussion avec le foret aspirant TE-CD ou TE-YD et dans des trous percés par carottage diamant avec utilisation de l'outil abrasif Hilti TE-YRT					
Classe de température I: 40°C/24°C	$\tau_{Rk,100,cr}$ [N/mm ²]	7,0	7,0	7,0	7,0
Classe de température II: 55°C/43°C	$\tau_{Rk,100,cr}$ [N/mm ²]	6,5	6,5	6,5	6,5
Classe de température III: 75°C/55°C	$\tau_{Rk,100,cr}$ [N/mm ²]	3,0	3,0	3,0	3,0
Influence des facteurs ψ sur la contrainte d'adhérence τ_{RK} dans du béton fissuré et non fissuré					
Influence de la résistance du béton					
dans des trous percés par percussion et dans des trous percés par percussion avec le foret aspirant TE-CD ou TE-YD et dans des trous percés par carottage diamant					
Classe de température I à III:	ψ_c [-]	$(f_{ck}/20)^{0,1}$			
dans des trous percés par carottage diamant avec utilisation de l'outil abrasif Hilti TE-YRT					
Classe de température I à III :	ψ_c [-]	2)	1,0	2)	
Influence de la charge permanente					
dans des trous percés par percussion et dans des trous percés par percussion avec le foret aspirant TE-CD ou TE-YD et dans des trous percés par carottage diamant avec utilisation de l'outil abrasif Hilti TE-YRT					
Classe de température I: 40°C/24°C	$\psi^0_{sus,100}$ [-]	0,85			
Classe de température II: 55°C/43°C	$\psi^0_{sus,100}$ [-]	0,72			
Classe de température III: 75°C/55°C	$\psi^0_{sus,100}$ [-]	0,69			
dans des trous percés par carottage diamant					
Classe de température I: 40°C/24°C	$\psi^0_{sus,100}$ [-]	0,70			
Classe de température II: 55°C/43°C	$\psi^0_{sus,100}$ [-]	0,67			
Classe de température III: 75°C/55°C	$\psi^0_{sus,100}$ [-]	0,62			

1) En l'absence de réglementation nationale

2) Performance non évaluée

Injection system Hilti HIT-RE 500 V4

Performances

Caractéristiques essentielles sous efforts de traction dans le béton

Annexe C12

Tableau C5: Caractéristiques essentielles des ancrages de traction Hilti HZA / HZA-R sous charge de traction dans le béton

HZA / HZA-R			M12	M16	M20	M24	M27
Diamètre de la barre d'armature	ϕ	[mm]	12	16	20	25	28
Rupture acier							
Résistance caractéristique HZA	$N_{Rk,s}$	[kN]	46	86	135	194	253
Résistance caractéristique HZA-R	$N_{Rk,s}$	[kN]	62	111	173	248	¹⁾
Coefficient partiel	$\gamma_{Ms,N}^{1)}$	[-]	1,4				
Facteur d'installation							
Perçage par percussion	γ_{inst}	[-]	1,0				
Perçage par percussion avec foret aspirant Hilti TE-CD ou TE-YD	γ_{inst}	[-]	1,0				
Carottage diamant	γ_{inst}	[-]	1,2	1,4			
Carottage diamant et abrasion avec le Hilti TE-YRT	γ_{inst}	[-]	¹⁾	1,0			
Perçage par percussion installation dans des trous inondés	γ_{inst}	[-]	1,4				
Rupture par cône béton							
Profondeur d'ancrage effective	h_{ef}	[mm]	h_{nom}				
Facteur pour le béton fissuré	$k_{cr,N}$	[-]	7,7				
Facteur pour le béton non fissuré	$k_{ucr,N}$	[-]	11,0				
Distance du bord	$c_{cr,N}$	[mm]	$1,5 \cdot h_{ef}$				
Entraxe	$s_{cr,N}$	[mm]	$3,0 \cdot h_{ef}$				
Rupture par fendage							
Distance du bord $c_{cr,sp}$ [mm] pour	$h / h_{ef} \geq 2,0$		$1,0 \cdot h_{ef}$				
	$2,0 > h / h_{ef} > 1,3$		$4,6 \cdot h_{ef} - 1,8 \cdot h$				
	$h / h_{ef} \leq 1,3$		$2,26 \cdot h_{ef}$				
Entraxe	$s_{cr,sp}$	[mm]	$2 \cdot c_{cr,sp}$				

Injection system Hilti HIT-RE 500 V4

Performances

Caractéristiques essentielles sous efforts de traction dans le béton

Annexe C13

Tableau C5: suite (1)

HZA / HZA-R		M12	M16	M20	M24	M27
Diamètre de la barre d'armature	ϕ [mm]	12	16	20	25	28
Rupture mixte par extraction et par cône béton pour une durée de vie de 50 ans						
Résistance caractéristique dans du béton non fissuré C20/25 dans des trous percés par percussion et dans des trous percés par percussion avec le foret aspirant TE-CD ou TE-YD et dans des trous percés par carottage diamant avec utilisation de l'outil abrasif Hilti TE-YRT						
Classe de température I: 40°C/24°C	$\tau_{RK,ucr}$ [N/mm ²]	15	15	14	14	14
Classe de température II: 55°C/43°C	$\tau_{RK,ucr}$ [N/mm ²]	12	12	12	11	11
Classe de température III: 75°C/55°C	$\tau_{RK,ucr}$ [N/mm ²]	5,0	4,5	4,5	4,5	4,5
Résistance caractéristique dans du béton non fissuré C20/25 dans des trous percés par carottage diamant						
Classe de température I: 40°C/24°C	$\tau_{RK,ucr}$ [N/mm ²]	9,5	9,5	9,5	9,5	10
Classe de température II: 55°C/43°C	$\tau_{RK,ucr}$ [N/mm ²]	8,5	8,5	8,5	8,5	8,5
Classe de température III: 75°C/55°C	$\tau_{RK,ucr}$ [N/mm ²]	4,0	4,0	4,0	4,5	4,5
Résistance caractéristique dans du béton non fissuré C20/25 dans des trous percés par percussion et installation dans des trous remplis d'eau						
Classe de température I: 40°C/24°C	$\tau_{RK,ucr}$ [N/mm ²]	13	12	12	12	12
Classe de température II: 55°C/43°C	$\tau_{RK,ucr}$ [N/mm ²]	11	10	10	10	9,5
Classe de température III: 75°C/55°C	$\tau_{RK,ucr}$ [N/mm ²]	4,0	4,0	4,0	4,0	3,5
Résistance caractéristique dans du béton fissuré C20/25 dans des trous percés par percussion et dans des trous percés par percussion avec le foret aspirant TE-CD ou TE-YD et dans des trous percés par carottage diamant avec utilisation de l'outil abrasif Hilti TE-YRT						
Classe de température I: 40°C/24°C	$\tau_{RK,cr}$ [N/mm ²]	12	12	12	11	11
Classe de température II: 55°C/43°C	$\tau_{RK,cr}$ [N/mm ²]	10	10	10	9,5	9,5
Classe de température III: 75°C/55°C	$\tau_{RK,cr}$ [N/mm ²]	4,0	4,0	3,5	3,5	3,5
Influence des facteurs ψ sur la contrainte d'adhérence τ_{RK} dans du béton fissuré et non fissuré						
Influence de la résistance du béton						
dans des trous percés par percussion et dans des trous percés par percussion avec le foret aspirant TE-CD ou TE-YD et dans des trous percés par carottage diamant						
Classe de température I à III:	ψ_c [-]	$(f_{ck}/20)^{0,1}$				
dans des trous percés par carottage diamant avec utilisation de l'outil abrasif Hilti TE-YRT						
Classe de température I à III :	ψ_c [-]	1)	1,0			
Influence de la charge permanente						
dans des trous percés par percussion et dans des trous percés par percussion avec le foret aspirant TE-CD ou TE-YD et dans des trous percés par carottage diamant avec utilisation de l'outil abrasif Hilti TE-YRT						
Classe de température I: 40°C/24°C	ψ_{sus}^0 [-]	0,88				
Classe de température II: 55°C/43°C	ψ_{sus}^0 [-]	0,72				
Classe de température III: 75°C/55°C	ψ_{sus}^0 [-]	0,69				
dans des trous percés par carottage diamant						
Classe de température I: 40°C/24°C	ψ_{sus}^0 [-]	0,89				
Classe de température II: 55°C/43°C	ψ_{sus}^0 [-]	0,70				
Classe de température III: 75°C/55°C	ψ_{sus}^0 [-]	0,62				

Injection system Hilti HIT-RE 500 V4

Performances

Caractéristiques essentielles sous efforts de traction dans le béton

Annexe C14

Tableau C5: suite (2)

HZA / HZA-R		M12	M16	M20	M24	M27
Diamètre de la barre d'armature	ϕ [mm]	12	16	20	25	28
Rupture mixte par extraction et par cône béton pour une durée de vie de 100 ans						
Résistance caractéristique dans du béton non fissuré C20/25 dans des trous percés par percussion et dans des trous percés par percussion avec le foret aspirant TE-CD ou TE-YD et dans des trous percés par carottage diamant avec utilisation de l'outil abrasif Hilti TE-YRT						
Classe de température I: 40°C/24°C	$\tau_{Rk,100,ucr}$ [N/mm ²]	15	15	14	14	14
Classe de température II: 55°C/43°C	$\tau_{Rk,100,ucr}$ [N/mm ²]	12	12	12	11	11
Classe de température III: 75°C/55°C	$\tau_{Rk,100,ucr}$ [N/mm ²]	5,0	4,5	4,5	4,5	4,5
Résistance caractéristique dans du béton non fissuré C20/25 dans des trous percés par carottage diamant						
Classe de température I: 40°C/24°C	$\tau_{Rk,100,ucr}$ [N/mm ²]	9,5	9,5	9,5	9,5	10
Classe de température II: 55°C/43°C	$\tau_{Rk,100,ucr}$ [N/mm ²]	8,5	8,5	8,5	8,5	8,5
Classe de température III: 75°C/55°C	$\tau_{Rk,100,ucr}$ [N/mm ²]	4,0	4,0	4,0	4,5	4,5
Résistance caractéristique dans du béton non fissuré C20/25 dans des trous percés par percussion et installation dans des trous remplis d'eau						
Classe de température I: 40°C/24°C	$\tau_{Rk,100,ucr}$ [N/mm ²]	13	12	12	12	12
Classe de température II: 55°C/43°C	$\tau_{Rk,100,ucr}$ [N/mm ²]	10	10	10	9,5	9,5
Classe de température III: 75°C/55°C	$\tau_{Rk,100,ucr}$ [N/mm ²]	4,0	4,0	4,0	4,0	3,5
Résistance caractéristique dans du béton fissuré C20/25 dans des trous percés par percussion et dans des trous percés par percussion avec le foret aspirant TE-CD ou TE-YD et dans des trous percés par carottage diamant avec utilisation de l'outil abrasif Hilti TE-YRT						
Classe de température I: 40°C/24°C	$\tau_{Rk,100,cr}$ [N/mm ²]	10	9,5	9,5	9,0	9,0
Classe de température II: 55°C/43°C	$\tau_{Rk,100,cr}$ [N/mm ²]	9,0	8,5	8,5	8,0	8,0
Classe de température III: 75°C/55°C	$\tau_{Rk,100,cr}$ [N/mm ²]	4,0	4,0	3,5	3,5	3,5
Influence des facteurs ψ sur la contrainte d'adhérence $\tau_{Rk,100}$ dans du béton fissuré et non fissuré						
Influence de la résistance du béton						
dans des trous percés par percussion et dans des trous percés par percussion avec le foret aspirant TE-CD ou TE-YD et dans des trous percés par carottage diamant						
Classe de température I à III:	ψ_c [-]	$(f_{ck}/20)^{0,1}$				
dans des trous percés par carottage diamant avec utilisation de l'outil abrasif Hilti TE-YRT						
Classe de température I à III :	ψ_c [-]	1)		1,0		
Influence de la charge permanente						
dans des trous percés par percussion et dans des trous percés par percussion avec le foret aspirant TE-CD ou TE-YD et dans des trous percés par carottage diamant avec utilisation de l'outil abrasif Hilti TE-YRT						
Classe de température I: 40°C/24°C	$\psi^0_{sus,100}$ [-]	0,85				
Classe de température II: 55°C/43°C	$\psi^0_{sus,100}$ [-]	0,72				
Classe de température III: 75°C/55°C	$\psi^0_{sus,100}$ [-]	0,69				
dans des trous percés par carottage diamant						
Classe de température I: 40°C/24°C	$\psi^0_{sus,100}$ [-]	0,70				
Classe de température II: 55°C/43°C	$\psi^0_{sus,100}$ [-]	0,67				
Classe de température III: 75°C/55°C	$\psi^0_{sus,100}$ [-]	0,62				

1) Performance non évaluée

Injection system Hilti HIT-RE 500 V4

Performances

Caractéristiques essentielles sous efforts de traction dans le béton

Annexe C15

Tableau C6: Caractéristiques essentielles pour les barres d'armature (rebars) sous charge de traction dans le béton

Barre d'armature (rebar)		φ8	φ10	φ12	φ14	φ16	φ18	φ20	φ24	φ25	φ28	φ30	φ32	
Pour une durée de vie de 50 et 100 ans														
Rupture acier														
Résistance caractéristique	$N_{Rk,s}$	[kN]		$A_s \cdot f_{uk}^{1)}$										
Résistance caractéristique Rebar B500B selon la DIN 488:2009-08 ²⁾	$N_{Rk,s}$	[kN]	28	43	62	85	111	140	173	249	270	339	389	442
Coefficient partiel Rebar B500B selon la DIN 488:2009-08 ³⁾	$\gamma_{Ms,N}^{4)}$	[-]		1,4										
Facteur d'installation														
Perçage par percussion	γ_{inst}	[-]		1,0										
Perçage par percussion avec foret aspirant Hilti TE-CD ou TE-YD	γ_{inst}	[-]		1,0										
Perçage par carottage diamant	γ_{inst}	[-]		1,2					1,4					
Perçage par carottage diamant et abrasion avec le Hilti TE-YRT	γ_{inst}	[-]		5)			1,0					5)		
Perçage par percussion et installation dans des trous remplis d'eau	γ_{inst}	[-]		1,4										
Rupture par cône béton														
Facteur pour le béton fissuré	$k_{Cr,N}$	[-]		7,7										
Facteur pour le béton non fissuré	$k_{Ucr,N}$	[-]		11,0										
Distance du bord	$c_{Cr,N}$	[mm]		$1,5 \cdot h_{ef}$										
Entraxe	$s_{Cr,N}$	[mm]		$3,0 \cdot h_{ef}$										
Rupture par fendage														
Distance du bord $c_{Cr,sp}$ [mm] pour	$h / h_{ef} \geq 2,0$			$1,0 \cdot h_{ef}$										
	$2,0 > h / h_{ef} > 1,3$			$4,6 \cdot h_{ef} - 1,8 \cdot h$										
	$h / h_{ef} \leq 1,3$			$2,26 \cdot h_{ef}$										
Entraxe	$s_{Cr,sp}$	[mm]		$2 \cdot c_{Cr,sp}$										

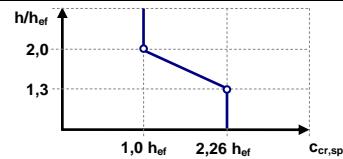

Injection system Hilti HIT-RE 500 V4

Performances

Caractéristiques essentielles sous efforts de traction dans le béton

Annexe C16

Tableau C6: suite (1)

Barre d'armature (rebar)	φ8	φ10	φ12	φ14	φ16	φ18	φ20	φ24	φ25	φ28	φ30	φ32	
Rupture mixte par extraction et par cône béton pour une durée de vie de 50 ans													
Résistance caractéristique dans du béton non fissuré C20/25 dans des trous percés par percussion et dans des trous percés par percussion avec le foret aspirant TE-CD ou TE-YD et dans des trous percés par carottage diamant avec utilisation de l'outil abrasif Hilti TE-YRT													
Classe de température I: 40°C/24°C	$\tau_{RK,ucr}$	[N/mm ²]	10	15	15	15	15	14	14	14	14	13	13
Classe de température II: 55°C/43°C	$\tau_{RK,ucr}$	[N/mm ²]	8,5	13	12	12	12	12	12	11	11	11	11
Classe de température III: 75°C/55°C	$\tau_{RK,ucr}$	[N/mm ²]	3,5	5,0	5,0	5,0	4,5	4,5	4,5	4,5	4,5	4,5	4,5
Résistance caractéristique dans du béton non fissuré C20/25 dans des trous percés par carottage diamant													
Classe de température I: 40°C/24°C	$\tau_{RK,ucr}$	[N/mm ²]	9,5	9,5	9,5	9,5	9,5	9,5	9,5	9,5	10	10	10
Classe de température II: 55°C/43°C	$\tau_{RK,ucr}$	[N/mm ²]	8,5	8,5	8,5	8,5	8,5	8,5	8,5	8,5	9,0	9,0	9,0
Classe de température III: 75°C/55°C	$\tau_{RK,ucr}$	[N/mm ²]	4,0	4,0	4,0	4,0	4,0	4,0	4,5	4,5	4,5	4,5	4,5
Résistance caractéristique dans du béton non fissuré C20/25 dans des trous percés par percussion et installation dans des trous remplis d'eau													
Classe de température I: 40°C/24°C	$\tau_{RK,ucr}$	[N/mm ²]	8,5	13	13	13	12	12	12	12	12	11	11
Classe de température II: 55°C/43°C	$\tau_{RK,ucr}$	[N/mm ²]	7,0	11	11	10	10	10	10	10	9,5	9,5	9,5
Classe de température III: 75°C/55°C	$\tau_{RK,ucr}$	[N/mm ²]	3,0	4,0	4,0	4,0	4,0	4,0	4,0	4,0	3,5	3,5	3,5
Résistance caractéristique dans du béton fissuré C20/25 dans des trous percés par percussion et dans des trous percés par percussion avec le foret aspirant TE-CD ou TE-YD et dans des trous percés par carottage diamant avec utilisation de l'outil abrasif Hilti TE-YRT													
Classe de température I: 40°C/24°C	$\tau_{RK,cr}$	[N/mm ²]	5,5	10	12	12	12	12	11	11	11	11	11
Classe de température II: 55°C/43°C	$\tau_{RK,cr}$	[N/mm ²]	5,0	8,5	10	10	10	10	9,5	9,5	9,5	9,5	9,0
Classe de température III: 75°C/55°C	$\tau_{RK,cr}$	[N/mm ²]	2,0	4,0	4,0	4,0	4,0	4,0	3,5	3,5	3,5	3,5	3,5
Influence des facteurs ψ sur la contrainte d'adhérence τ_{RK} dans du béton fissuré et non fissuré													
Influence de la résistance du béton													
dans des trous percés par percussion et dans des trous percés par percussion avec le foret aspirant TE-CD ou TE-YD et dans des trous percés par carottage diamant													
Classe de température I à III:	ψ_c	[-]	$(f_{ck}/20)^{0,1}$										
dans des trous percés par carottage diamant avec utilisation de l'outil abrasif Hilti TE-YRT													
Classe de température I à III :	ψ_c	[-]	5)					1,0			5)		
Influence de la charge permanente													
dans des trous percés par percussion et dans des trous percés par percussion avec le foret aspirant TE-CD ou TE-YD et dans des trous percés par carottage diamant avec utilisation de l'outil abrasif Hilti TE-YRT													
Classe de température I: 40°C/24°C	ψ^0_{sus}	[-]	0,88										
Classe de température II: 55°C/43°C	ψ^0_{sus}	[-]	0,72										
Classe de température III: 75°C/55°C	ψ^0_{sus}	[-]	0,69										
dans des trous percés par carottage diamant													
Classe de température I: 40°C/24°C	ψ^0_{sus}	[-]	0,89										
Classe de température II: 55°C/43°C	ψ^0_{sus}	[-]	0,70										
Classe de température III: 75°C/55°C	ψ^0_{sus}	[-]	0,62										

Injection system Hilti HIT-RE 500 V4

Performances

Caractéristiques essentielles sous efforts de traction dans le béton

Annexe C17

Tableau C6: suite (2)

Barre d'armature (rebar)	φ8	φ10	φ12	φ14	φ16	φ18	φ20	φ24	φ25	φ28	φ30	φ32		
Rupture mixte par extraction et par cône béton pour une durée de vie de 100 ans														
Résistance caractéristique dans du béton non fissuré C20/25 dans des trous percés par percussion et dans des trous percés par percussion avec le foret aspirant TE-CD ou TE-YD et dans des trous percés par carottage diamant avec utilisation de l'outil abrasif Hilti TE-YRT														
Classe de température I: 40°C/24°C $\tau_{Rk,100,ucr}$ [N/mm ²]	10	15	15	15	15	14	14	14	14	14	13	13		
Classe de température II: 55°C/43°C $\tau_{Rk,100,ucr}$ [N/mm ²]	8,0	12	12	12	12	12	12	11	11	11	11	11		
Classe de température III: 75°C/55°C $\tau_{Rk,100,ucr}$ [N/mm ²]	3,0	5,0	5,0	5,0	4,5	4,5	4,5	4,5	4,5	4,5	4,5	4,5		
Résistance caractéristique dans du béton non fissuré C20/25 dans des trous percés par carottage diamant														
Classe de température I: 40°C/24°C $\tau_{Rk,100,ucr}$ [N/mm ²]	9,5	9,5	9,5	9,5	9,5	9,5	9,5	9,5	9,5	10	10	10		
Classe de température II: 55°C/43°C $\tau_{Rk,100,ucr}$ [N/mm ²]	8,5	8,5	8,5	8,5	8,5	8,5	8,5	8,5	8,5	8,5	9,0	9,0		
Classe de température III: 75°C/55°C $\tau_{Rk,100,ucr}$ [N/mm ²]	4,0	4,0	4,0	4,0	4,0	4,0	4,0	4,5	4,5	4,5	4,5	4,5		
Résistance caractéristique dans du béton non fissuré C20/25 dans des trous percés par percussion et installation dans des trous remplis d'eau														
Classe de température I: 40°C/24°C $\tau_{Rk,100,ucr}$ [N/mm ²]	8,5	13	13	13	12	12	12	12	12	12	11	11		
Classe de température II: 55°C/43°C $\tau_{Rk,100,ucr}$ [N/mm ²]	7,0	11	10	10	10	10	10	9,5	9,5	9,5	9,5	9,0		
Classe de température III: 75°C/55°C $\tau_{Rk,100,ucr}$ [N/mm ²]	2,5	4,0	4,0	4,0	4,0	4,0	4,0	4,0	4,0	3,5	3,5	3,5		
Résistance caractéristique dans du béton fissuré C20/25 dans des trous percés par percussion et dans des trous percés par percussion avec le foret aspirant TE-CD ou TE-YD et dans des trous percés par carottage diamant avec utilisation de l'outil abrasif Hilti TE-YRT														
Classe de température I: 40°C/24°C $\tau_{Rk,100,cr}$ [N/mm ²]	5,0	9,0	10	10	9,5	9,5	9,5	9,0	9,0	9,0	9,0	9,0		
Classe de température II: 55°C/43°C $\tau_{Rk,100,cr}$ [N/mm ²]	4,5	8,0	9,0	9,0	8,5	8,5	8,5	8,0	8,0	8,0	8,0	8,0		
Classe de température III: 75°C/55°C $\tau_{Rk,100,cr}$ [N/mm ²]	2,0	4,0	4,0	4,0	4,0	4,0	3,5	3,5	3,5	3,5	3,5	3,5		
Influence des facteurs ψ sur la contrainte d'adhérence $\tau_{Rk,100}$ dans du béton fissuré et non fissuré														
Influence de la résistance du béton														
dans des trous percés par percussion et dans des trous percés par percussion avec le foret aspirant TE-CD ou TE-YD et dans des trous percés par carottage diamant														
Classe de température I à III:	ψ_c	[-] $(f_{ck}/20)^{0,1}$												
dans des trous percés par carottage diamant avec utilisation de l'outil abrasif Hilti TE-YRT														
Classe de température I à III :	ψ_c	[-] 5)					1,0					5)		
Influence de la charge permanente														
dans des trous percés par percussion et dans des trous percés par percussion avec le foret aspirant TE-CD ou TE-YD et dans des trous percés par carottage diamant avec utilisation de l'outil abrasif Hilti TE-YRT														
Classe de température I: 40°C/24°C	$\psi^{0}_{sus,100}$	[-] 0,85												
Classe de température II: 55°C/43°C	$\psi^{0}_{sus,100}$	[-] 0,72												
Classe de température III: 75°C/55°C	$\psi^{0}_{sus,100}$	[-] 0,69												
dans des trous percés par carottage diamant														
Classe de température I: 40°C/24°C	$\psi^{0}_{sus,100}$	[-] 0,70												
Classe de température II: 55°C/43°C	$\psi^{0}_{sus,100}$	[-] 0,67												
Classe de température III: 75°C/55°C	$\psi^{0}_{sus,100}$	[-] 0,62												

1) Performance non évaluée

Injection system Hilti HIT-RE 500 V4

Performances

Caractéristiques essentielles sous efforts de cisaillement dans le béton

Annexe C18

Tableau C7: Caractéristiques essentielles des tiges filetées métriques selon l'Annexe A sous effort de cisaillement dans le béton

Tiges filetées métriques selon l'Annexe A			M8	M10	M12	M16	M20	M24	M27	M30	
Pour une durée de vie de 50 et 100 ans											
Rupture acier sans bras de levier											
Résistance caractéristique	$V_{RK,s}^0$	[kN]									$k_6 \cdot A_s \cdot f_{uk}$
Facteur classe 5.8	k_6	[-]									0,6
Facteur classe 6.8, 8.8	k_6	[-]									0,5
Facteur HAS A4, HAS-U A4, HIT-V-R Tiges filetées: CRC II et III (Tableau A1)	k_6	[-]									0,5
Facteur HAS-U HCR, HIT-V-HCR Tiges filetées: CRC V (Tableau A1)	k_6	[-]									0,5
Facteur partiel classe 5.8, 6.8, 8.8	$\gamma_{Ms,V}^{1)}$										1,25
Facteur partiel HAS A4, HAS-U A4, HIT-V-R, Tiges filetées: CRC II et III (Tableau A1)	$\gamma_{Ms,V}^{1)}$	[-]	1,56						2,38		
Facteur partiel HAS-U HCR, HIT-V-HCR Tiges filetées: CRC V (Tableau A1)	$\gamma_{Ms,V}^{1)}$	[-]	1,25						1,75		
Facteur de ductilité	k_7	[-]									1,0
Rupture acier avec bras de levier											
Moment de flexion	$M_{RK,s}^0$	[Nm]									$1,2 \cdot W_{el} \cdot f_{uk}$
Facteur de ductilité	k_7	[-]									1,0
Rupture du béton par effet levier											
Facteur de rupture du béton par effet levier	k_8	[-]									2,0
Rupture en bord de dalle											
Longueur effective de la fixation	l_f	[mm]	min (h_{ef} ; $12 \cdot d_{nom}$; 300)							min (h_{ef} ; $8 \cdot d_{nom}$; 300)	
Diamètre externe de la fixation	d_{nom}	[mm]	8	10	12	16	20	24	27	30	

1) En l'absence de réglementation nationale.

Injection system Hilti HIT-RE 500 V4

Performances

Caractéristiques essentielles sous efforts de cisaillement dans le béton

Annexe C19

Tableau C8: Caractéristiques essentielles des tiges filetées impériales selon l'Annexe A sous effort de cisaillement dans le béton

Tiges filetées impériales selon l'Annexe A		[in.]	3/8	1/2	5/8	3/4	7/8	1	1 1/4	
Pour une durée de vie de 50 et 100 ans										
Rupture acier sans bras de levier										
Résistance caractéristique	$V_{Rk,s}^0$	[kN]	$k_6 \cdot A_s \cdot f_{uk}$							
Facteur HIT-V	k_6	[-]	0,6							
Facteur HAS-E-36	k_6	[-]	0,6							
Facteur HAS-E-55	k_6	[-]	0,5							
Facteur HAS-B-105	k_6	[-]	0,5							
Facteur HAS-R 304	k_6	[-]	0,5							
Facteur HAS-R 316	k_6	[-]	0,5							
Facteur partiel HIT-V	$\gamma_{Ms,V}^{1)}$	[-]	1,60							
Facteur partiel HAS-E-36	$\gamma_{Ms,V}^{1)}$	[-]	1,61							
Facteur partiel HAS-E-55	$\gamma_{Ms,V}^{1)}$	[-]	1,36							
Facteur partiel HAS-B-105	$\gamma_{Ms,V}^{1)}$	[-]	1,50							
Facteur partiel HAS-R 304	$\gamma_{Ms,V}^{1)}$	[-]	1,54		1,89			2,51		
Facteur partiel HAS-R 316	$\gamma_{Ms,V}^{1)}$	[-]	1,54		1,89					
Facteur de ductilité	k_7	[-]	1,0							
Rupture acier avec bras de levier										
Moment de flexion	$M_{Rk,s}^0$	[Nm]	$1,2 \cdot W_{el} \cdot f_{uk}$							
Facteur de ductilité	k_7	[-]	1,0							
Rupture du béton par effet levier										
Facteur de rupture du béton par effet levier	k_8	[-]	2,0							
Rupture en bord de dalle										
Longueur effective de la fixation	l_f	[mm]	min (h_{ef} ; $12 \cdot d_{nom}$)					min (h_{ef} ; $8 \cdot d_{nom}$; 300)		
Diamètre externe de la fixation	d_{nom}	[mm]	9,5	12,7	15,9	19,1	22,2	25,4	31,8	

1) En l'absence de réglementation nationale.

Injection system Hilti HIT-RE 500 V4

Performances

Caractéristiques essentielles sous efforts de cisaillement dans le béton

Annexe C20

Tableau C9: Caractéristiques essentielles des douilles taraudées HIS-(R)N sous effort de cisaillement dans le béton

HIS-(R)N			M8	M10	M12	M16	M20
Pour une durée de vie de 50 et 100 ans							
Rupture acier sans bras de levier							
Resistance caractéristique	$V_{Rk,s}^0$	[kN]	13	23	34	63	58
Facteur partiel	$\gamma_{Ms,V}^{1)}$	[-]	1,25				
Resistance caractéristique HIS-RN avec une vis de classe 70	$V_{Rk,s}$	[kN]	13	20	30	55	83
Coefficient partiel	$\gamma_{Ms,V}^{1)}$	[-]	1,56				
Facteur de ductilité	k_7	[-]	1,0				
Rupture acier avec bras de levier							
HIS-N avec une vis de classe 8.8	$M_{Rk,s}^0$	[Nm]	30	60	105	266	519
HIS-RN avec une vis de classe 70	$M_{Rk,s}^0$	[Nm]	26	52	92	233	454
Facteur de ductilité	k_7	[-]	1,0				
Rupture du béton par effet levier							
Facteur de rupture du béton par effet levier	k_8	[-]	2,0				
Rupture en bord de dalle							
Longueur effective de la fixation	l_f	[mm]	90	110	125	170	205
Diamètre externe de la fixation	d_{nom}	[mm]	12,5	16,5	20,5	25,4	27,6

1) En l'absence de réglementation nationale.

Injection system Hilti HIT-RE 500 V4

Performances

Caractéristiques essentielles sous efforts de cisaillement dans le béton

Annexe C21

Tableau C10: Caractéristiques essentielles des douilles taraudées HIS-(R)N sous effort de cisaillement dans le béton

HIS-(R)N, taille	[in.]	3/8	1/2	5/8	3/4
Pour une durée de vie de 50 et 100 ans					
Rupture acier sans bras de levier					
Résistance caractéristique HIS-N Vis selon SAE J429 Classe 5 ou ASTM A325 (1/2 in. à 3/4 in.)	$V^0_{Rk,s}$ [kN]	21	38	60	65
Facteur partiel	$\gamma_{Ms,V}^{1)}$ [-]	1,50			1,25
Résistance caractéristique HIS-N Vis selon ASTM A193 Classe B7	$V^0_{Rk,s}$ [kN]	22	40	63	65
Facteur partiel	$\gamma_{Ms,V}^{1)}$ [-]	1,50			1,25
Résistance caractéristique HIS-RN Vis selon ASTM A193 Classe B8M (AISI 316)	$V^0_{Rk,s}$ [kN]	19	35	55	93
Facteur partiel	$\gamma_{Ms,V}^{1)}$ [-]	1,50			2,00
Résistance caractéristique HIS-RN Vis selon ASTM A193 Classe B8T (AISI 321)	$V^0_{Rk,s}$ [kN]	22	40	63	93
Facteur partiel	$\gamma_{Ms,V}^{1)}$ [-]	1,50			2,00
Facteur de ductilité	k_7 [-]	1,0			
Rupture acier avec bras de levier					
Résistance caractéristique HIS-N Vis selon SAE J429 Classe 5 ou ASTM A325 (1/2 in. à 3/4 in.)	$M^0_{Rk,s}$ [Nm]	50	123	247	444
Résistance caractéristique HIS-N Vis selon ASTM A193 Classe B7	$M^0_{Rk,s}$ [Nm]	52	128	257	463
Résistance caractéristique HIS-RN Vis selon ASTM A193 Classe B8M (AISI 316)	$M^0_{Rk,s}$ [Nm]	45	113	226	407
Résistance caractéristique HIS-RN Vis selon ASTM A193 Classe B8T (AISI 321)	$M^0_{Rk,s}$ [Nm] ([ft-lb])	52	128	257	463
Facteur de ductilité	k_7 [-]	1,0			
Rupture du béton par effet levier					
Facteur de rupture du béton par effet levier	k_8 [-]	2,0			
Rupture en bord de dalle					
Longueur effective de la fixation	l_f [mm]	110	125	170	205
Diamètre externe de la fixation	d_{nom} [mm]	16,5	20,5	25,4	27,6

1) En l'absence de réglementation nationale.

Injection system Hilti HIT-RE 500 V4

Performances

Caractéristiques essentielles sous efforts de cisaillement dans le béton

Annexe C22

Tableau C11: Caractéristiques essentielles pour les Hilti tension anchor HZA / HZA-R sous charge de cisaillement dans le béton

HZA / HZA-R			M12	M16	M20	M24	M27
Diamètre de la barre d'armature	ϕ	[mm]	12	16	20	25	28
Rupture de l'acier sans bras de levier							
Résistance caractéristique HZA	$V^0_{Rk,s}$	[kN]	23	43	67	97	126
Résistance caractéristique HZA-R	$V^0_{Rk,s}$	[kN]	31	55	86	124	²⁾
Facteur partiel	$\gamma_{Ms,V}^{1)}$	[-]	1,5				
Facteur de ductilité	k_7	[-]	1,0				
Rupture de l'acier avec bras de levier							
Résistance caractéristique HZA	$M^0_{Rk,s}$	[Nm]	72	183	357	617	915
Résistance caractéristique HZA-R	$M^0_{Rk,s}$	[Nm]	97	234	457	790	²⁾
Facteur partiel	$\gamma_{Ms,V}^{1)}$	[-]	1,5				
Facteur de ductilité	k_7	[-]	1,0				
Rupture du béton par effet levier							
Facteur pour la rupture du béton par effet levier	k_8	[-]	2,0				
Rupture du béton par effet de bord							
Longueur effective de la fixation	l_f	[mm]	min (h_{ef} ; $12 \cdot d_{nom}$; 300)				
Diamètre externe de l'ancrage	d_{nom}	[mm]	12	16	20	24	27

¹⁾ En l'absence de réglementation nationale.

²⁾ Aucune performance évaluée.

Injection system Hilti HIT-RE 500 V4

Performances

Caractéristiques essentielles sous charge de cisaillement dans le béton

Annexe C23

Tableau C12: Caractéristiques essentielles pour les barres d'armature (rebars) sous charge de cisaillement dans le béton

Barre d'armature (rebar)	φ8	φ10	φ12	φ14	φ16	φ18	φ20	φ24	φ25	φ28	φ30	φ32		
Pour une durée de vie de 50 et 100 ans														
Rupture de l'acier sans bras de levier														
Résistance caractéristique	$V_{Rk,s}^0$ [kN]		$0,5 \cdot A_s \cdot f_{uk}^{1)}$											
Résistance caractéristique Rebar B500B selon DIN 488:2009-08 ²⁾	$V_{Rk,s}^0$ [kN]		14	22	31	42	55	70	86	124	135	169	194	221
Facteur partiel Rebar B500B selon DIN 488:2009-08 ³⁾	$\gamma_{Ms,V}^{4)}$ [-]		1,5											
Facteur de ductilité	k_7 [-]		1,0											
Rupture de l'acier avec bras de levier														
Résistance caractéristique	$M_{Rk,s}^0$ [Nm]		$1,2 \cdot W_{el} \cdot f_{uk}^{1)}$											
Résistance caractéristique Rebar B500B selon la DIN 488:2009-08	$M_{Rk,s}^0$ [Nm]		33	65	112	178	265	378	518	896	1012	1422	1749	2123
Facteur de ductilité	k_7 [-]		1,0											
Rupture du béton par effet levier														
Facteur pour la rupture du béton par effet levier	k_8 [-]		2,0											
Rupture du béton par effet de bord														
Longueur effective de la fixation	l_f [mm]		$\min(h_{ef,i}; 12 \cdot d_{nom})$							$\min(h_{ef,i}; 8 \cdot d_{nom}; 300)$				
Diamètre externe de l'ancrage	d_{nom} [mm]		8	10	12	14	16	18	20	24	25	28	30	32

- 1) f_{uk} selon les spécifications de la barre d'armature
- 2) Les valeurs doivent être calculées selon EAD 330499-01, Eq. 2.1, si les barres d'armature ne répondent pas aux prérequis de la DIN 488.
- 3) Les valeurs doivent être calculées selon EN 1992-4:2018, Tab 4.1, si les barres d'armature ne répondent pas aux prérequis de la DIN 488.
- 4) En l'absence de réglementation nationale.

Injection system Hilti HIT-RE 500 V4

Performances

Caractéristiques essentielles sous charge de cisaillement dans le béton

Annexe C24

Tableau C13: Déplacements des tiges filetées sous charge de traction dans le béton

Tige filetée, HAS-U-..., HIT-V-..., AM...8.8		M8	M10	M12	M16	M20	M24	M27	M30
Tige filetée, HAS-..., HIT-V-..., taille		-	3/8	1/2	5/8	3/4	7/8	1	1 1/4
Déplacement dans le béton non fissuré									
Classe de température I: 40°C / 24°C	δ_{N0} [mm/(N/mm ²)]	0,04	0,05	0,05	0,06	0,06	0,07	0,08	0,08
	$\delta_{N\infty}$ [mm/(N/mm ²)]	0,10	0,11	0,12	0,13	0,15	0,17	0,18	0,19
Classe de température II: 55°C / 43°C	δ_{N0} [mm/(N/mm ²)]	0,05	0,05	0,06	0,07	0,07	0,08	0,09	0,10
	$\delta_{N\infty}$ [mm/(N/mm ²)]	0,12	0,13	0,14	0,16	0,18	0,20	0,21	0,23
Classe de température III: 75°C / 55°C	δ_{N0} [mm/(N/mm ²)]	0,05	0,06	0,06	0,07	0,08	0,09	0,09	0,10
	$\delta_{N\infty}$ [mm/(N/mm ²)]	0,12	0,13	0,15	0,17	0,19	0,21	0,23	0,24
Déplacement dans le béton fissuré									
Classe de température I: 40°C / 24°C	δ_{N0} [mm/(N/mm ²)]	0,02	0,03	0,05	0,08	0,10	0,13	0,15	0,18
	$\delta_{N\infty}$ [mm/(N/mm ²)]	0,12	0,19	0,14	0,19	0,16	0,16	0,15	0,18
Classe de température II: 55°C / 43°C	δ_{N0} [mm/(N/mm ²)]	0,02	0,04	0,06	0,09	0,12	0,16	0,18	0,21
	$\delta_{N\infty}$ [mm/(N/mm ²)]	0,15	0,23	0,17	0,23	0,19	0,19	0,18	0,21
Classe de température III: 75°C / 55°C	δ_{N0} [mm/(N/mm ²)]	0,02	0,04	0,06	0,10	0,13	0,17	0,19	0,22
	$\delta_{N\infty}$ [mm/(N/mm ²)]	0,16	0,24	0,18	0,24	0,20	0,20	0,19	0,22

Tableau C14: Déplacements des douilles taraudées HIS-(R)N sous charge de traction dans le béton

HIS-(R)N		M8	M10	M12	M16	M20
HIS-(R)N, taille [in.]		-	3/8	1/2	5/8	3/4
Déplacement dans le béton non fissuré						
Classe de température I: 40°C / 24°C	δ_{N0} [mm/(N/mm ²)]	0,05	0,06	0,06	0,07	0,08
	$\delta_{N\infty}$ [mm/(N/mm ²)]	0,12	0,13	0,15	0,17	0,18
Classe de température II: 55°C / 43°C	δ_{N0} [mm/(N/mm ²)]	0,06	0,07	0,07	0,08	0,09
	$\delta_{N\infty}$ [mm/(N/mm ²)]	0,14	0,16	0,18	0,20	0,21
Classe de température III: 75°C / 55°C	δ_{N0} [mm/(N/mm ²)]	0,06	0,07	0,07	0,09	0,10
	$\delta_{N\infty}$ [mm/(N/mm ²)]	0,15	0,16	0,19	0,21	0,22
Déplacement dans le béton fissuré						
Classe de température I: 40°C / 24°C	δ_{N0} [mm/(N/mm ²)]	0,02	0,03	0,05	0,08	0,10
	$\delta_{N\infty}$ [mm/(N/mm ²)]	0,12	0,19	0,14	0,19	0,16
Classe de température II: 55°C / 43°C	δ_{N0} [mm/(N/mm ²)]	0,02	0,04	0,06	0,09	0,12
	$\delta_{N\infty}$ [mm/(N/mm ²)]	0,15	0,23	0,17	0,23	0,19
Classe de température III: 75°C / 55°C	δ_{N0} [mm/(N/mm ²)]	0,02	0,04	0,06	0,10	0,13
	$\delta_{N\infty}$ [mm/(N/mm ²)]	0,16	0,24	0,18	0,24	0,20

Injection system Hilti HIT-RE 500 V4

Performances

Déplacements sous charge de traction dans le béton

Annexe C25

Tableau C15: Déplacements des Hilti tension anchor HZA / HZA-R sous charge de traction dans le béton

HZA / HZA-R		M12	M16	M20	M24	M27
Diamètre de la barre d'armature	ϕ [mm]	12	16	20	25	28
Déplacement dans le béton non fissuré						
Classe de température I: 40°C / 24°C	δ_{N0} [mm/(N/mm ²)]	0,05	0,06	0,07	0,07	0,08
	$\delta_{N\infty}$ [mm/(N/mm ²)]	0,12	0,15	0,17	0,18	0,19
Classe de température II: 55°C / 43°C	δ_{N0} [mm/(N/mm ²)]	0,06	0,07	0,09	0,09	0,09
	$\delta_{N\infty}$ [mm/(N/mm ²)]	0,14	0,18	0,20	0,21	0,22
Classe de température III: 75°C / 55°C	δ_{N0} [mm/(N/mm ²)]	0,07	0,08	0,09	0,09	0,10
	$\delta_{N\infty}$ [mm/(N/mm ²)]	0,15	0,19	0,22	0,22	0,23
Déplacement dans le béton fissuré						
Classe de température I: 40°C / 24°C	δ_{N0} [mm/(N/mm ²)]	0,06	0,10	0,14	0,15	0,16
	$\delta_{N\infty}$ [mm/(N/mm ²)]	0,06	0,16	0,16	0,15	0,16
Classe de température II: 55°C / 43°C	δ_{N0} [mm/(N/mm ²)]	0,07	0,12	0,17	0,17	0,19
	$\delta_{N\infty}$ [mm/(N/mm ²)]	0,07	0,19	0,19	0,18	0,19
Classe de température III: 75°C / 55°C	δ_{N0} [mm/(N/mm ²)]	0,08	0,13	0,17	0,18	0,20
	$\delta_{N\infty}$ [mm/(N/mm ²)]	0,08	0,20	0,20	0,19	0,20

Tableau C16: Déplacements des barres d'armature (rebar) sous charge de traction dans le béton

Barre d'armature (rebar)		$\phi 8$	$\phi 10$	$\phi 12$	$\phi 14$	$\phi 16$	$\phi 18$
Déplacement dans le béton non fissuré							
Classe de température I: 40°C / 24°C	δ_{N0} [mm/(N/mm ²)]	0,04	0,05	0,05	0,06	0,06	0,07
	$\delta_{N\infty}$ [mm/(N/mm ²)]	0,10	0,11	0,12	0,13	0,15	0,16
Classe de température II: 55°C / 43°C	δ_{N0} [mm/(N/mm ²)]	0,05	0,05	0,06	0,07	0,07	0,08
	$\delta_{N\infty}$ [mm/(N/mm ²)]	0,12	0,13	0,14	0,16	0,18	0,19
Classe de température III: 75°C / 55°C	δ_{N0} [mm/(N/mm ²)]	0,05	0,06	0,07	0,07	0,08	0,08
	$\delta_{N\infty}$ [mm/(N/mm ²)]	0,12	0,13	0,15	0,17	0,19	0,21
Déplacement dans le béton fissuré							
Classe de température I: 40°C / 24°C	δ_{N0} [mm/(N/mm ²)]	0,02	0,03	0,06	0,08	0,10	0,11
	$\delta_{N\infty}$ [mm/(N/mm ²)]	0,12	0,19	0,06	0,19	0,16	0,16
Classe de température II: 55°C / 43°C	δ_{N0} [mm/(N/mm ²)]	0,02	0,04	0,07	0,09	0,12	0,14
	$\delta_{N\infty}$ [mm/(N/mm ²)]	0,15	0,23	0,07	0,23	0,19	0,19
Classe de température III: 75°C / 55°C	δ_{N0} [mm/(N/mm ²)]	0,02	0,04	0,08	0,10	0,13	0,14
	$\delta_{N\infty}$ [mm/(N/mm ²)]	0,16	0,24	0,08	0,24	0,20	0,20

Injection system Hilti HIT-RE 500 V4

Performances

Déplacements sous charge de traction dans le béton

Annexe C26

Tableau C2: Déplacements pour les barres d'armature (rebar) sous charge de traction dans le béton

Barre d'armature (rebar)		φ20	φ24	φ25	φ28	φ30	φ32
Déplacement dans le béton non fissuré							
Classe de température I: 40°C / 24°C	δ_{N0} [mm/(N/mm ²)]	0,07	0,07	0,07	0,08	0,08	0,08
	$\delta_{N\infty}$ [mm/(N/mm ²)]	0,17	0,19	0,18	0,19	0,19	0,20
Classe de température II: 55°C / 43°C	δ_{N0} [mm/(N/mm ²)]	0,09	0,08	0,09	0,09	0,10	0,10
	$\delta_{N\infty}$ [mm/(N/mm ²)]	0,20	0,21	0,21	0,22	0,23	0,24
Classe de température III: 75°C / 55°C	δ_{N0} [mm/(N/mm ²)]	0,09	0,09	0,09	0,10	0,10	0,11
	$\delta_{N\infty}$ [mm/(N/mm ²)]	0,22	0,22	0,22	0,23	0,24	0,25
Déplacement dans le béton fissuré							
Classe de température I: 40°C / 24°C	δ_{N0} [mm/(N/mm ²)]	0,14	0,15	0,15	0,16	0,18	0,19
	$\delta_{N\infty}$ [mm/(N/mm ²)]	0,16	0,16	0,15	0,16	0,18	0,19
Classe de température II: 55°C / 43°C	δ_{N0} [mm/(N/mm ²)]	0,17	0,17	0,17	0,19	0,21	0,22
	$\delta_{N\infty}$ [mm/(N/mm ²)]	0,19	0,19	0,18	0,19	0,21	0,22
Classe de température III: 75°C / 55°C	δ_{N0} [mm/(N/mm ²)]	0,17	0,18	0,18	0,20	0,22	0,24
	$\delta_{N\infty}$ [mm/(N/mm ²)]	0,20	0,20	0,19	0,20	0,22	0,24

Injection system Hilti HIT-RE 500 V4

Performances

Déplacements sous charge de traction dans le béton

Annexe C27

Tableau C18: Déplacements pour les tiges filetées sous charge de cisaillement dans le béton

Tige filetée, HAS-U-..., HIT-V-..., AM...8.8		M8	M10	M12	M16	M20	M24	M27	M30
Tige filetée, HAS-..., HIT-V-..., taille [in.]		-	3/8	1/2	5/8	3/4	7/8	1	1 1/4
Déplacement	δ_{v0} [mm/kN]	0,06	0,06	0,05	0,04	0,04	0,03	0,03	0,03
	$\delta_{v\infty}$ [mm/kN]	0,09	0,08	0,08	0,06	0,06	0,05	0,05	0,05

Tableau C19: Déplacements pour les douilles taraudées HIS-(R)N sous charge de cisaillement dans le béton

HIS-(R)N		M8	M10	M12	M16	M20
HIS-(R)N, taille [in.]		-	3/8	1/2	5/8	3/4
Déplacement	δ_{v0} [mm/kN]	0,06	0,06	0,05	0,04	0,04
	$\delta_{v\infty}$ [mm/kN]	0,09	0,08	0,08	0,06	0,06

Tableau C20: Déplacements Hilti tension anchor HZA / HZA-R sous charge de cisaillement dans le béton

HZA / HZA-R		M12	M16	M20	M24	M27
Déplacement	δ_{v0} [mm/kN]	0,05	0,04	0,04	0,03	0,03
	$\delta_{v\infty}$ [mm/kN]	0,08	0,06	0,06	0,05	0,05

Table C3: Déplacements des barres d'armature (rebar) sous charge de cisaillement dans le béton

Barre d'armature (rebar)		φ8	φ10	φ12	φ14	φ16	φ18
Déplacement	δ_{v0} [mm/kN]	0,05	0,05	0,05	0,04	0,04	0,04
	$\delta_{v\infty}$ [mm/kN]	0,08	0,08	0,07	0,06	0,06	0,06

Table C22: Déplacements des barres d'armature (rebar) sous charge de cisaillement dans le béton

Barre d'armature (rebar)		φ20	φ24	φ25	φ28	φ30	φ32
Déplacement	δ_{v0} [mm/kN]	0,04	0,03	0,03	0,03	0,03	0,03
	$\delta_{v\infty}$ [mm/kN]	0,05	0,05	0,05	0,05	0,04	0,04

Injection system Hilti HIT-RE 500 V4

Performances

Déplacements sous charge de cisaillement dans le béton

Annexe C28

Tableau C23: Caractéristiques essentielles pour les tiges filetées métriques selon l'Annexe A sous charge de traction pour la catégorie sismique C1 dans le béton

Tige filetée métriques selon l'Annexe A	M8	M10	M12	M16	M20	M24	M27	M30	
Pour une durée de vie de 50 et 100 ans									
Rupture de l'acier									
Résistance caractéristique	$N_{Rk,s,C1}$ [kN]			$A_s \cdot f_{uk}$					
Rupture mixte par extraction et par cône béton pour une durée de vie de 50 ans									
Résistance caractéristique dans du béton fissuré C20/25 dans des trous percés par percussion et dans des trous percés par percussion avec le foret aspirant TE-CD ou TE-YD et dans des trous percés par carottage diamant avec utilisation de l'outil abrasif Hilti TE-YRT									
Classe de température I: 40°C/24°C	$\tau_{Rk,C1}$ [N/mm ²]	6,8	8,2	10,1	10,5	9,7	9,4	9,0	8,5
Classe de température II: 55°C/43°C	$\tau_{Rk,C1}$ [N/mm ²]	6,3	7,3	8,3	8,1	7,8	7,9	7,5	7,0
Classe de température III: 75°C/55°C	$\tau_{Rk,C1}$ [N/mm ²]	3,6	3,2	3,2	3,3	2,9	3,0	3,0	3,0
Rupture mixte par extraction et par cône béton pour une durée de vie de 100 ans									
Résistance caractéristique dans du béton fissuré C20/25 dans des trous percés par percussion et dans des trous percés par percussion avec le foret aspirant TE-CD ou TE-YD et dans des trous percés par carottage diamant avec utilisation de l'outil abrasif Hilti TE-YRT									
Classe de température I: 40°C/24°C	$\tau_{Rk,100,C1}$ [N/mm ²]	6,3	7,3	8,3	8,1	7,8	7,4	7,0	6,5
Classe de température II: 55°C/43°C	$\tau_{Rk,100,C1}$ [N/mm ²]	5,4	6,4	7,4	7,1	6,8	6,4	6,5	6,0
Classe de température III: 75°C/55°C	$\tau_{Rk,100,C1}$ [N/mm ²]	3,6	3,2	3,2	3,3	2,9	3,0	3,0	3,0
Influence des facteurs ψ sur la contrainte d'adhérence $\tau_{Rk,C1}$ et $\tau_{Rk,100,C1}$									
Influence de la résistance du béton									
Classe de température I à III:	ψ_c [-]	1,0							

Tableau C24: Caractéristiques essentielles pour les tiges filetées impériales selon l'Annexe A sous charge de traction pour la catégorie sismique C1 dans le béton

Tige filetée impériales selon l'Annexe A	[in.]	3/8	1/2	5/8	3/4	7/8	1	1 1/4
Pour une durée de vie de 50 et 100 ans								
Rupture de l'acier								
Résistance caractéristique	$N_{Rk,s,C1}$ [kN]			$A_s \cdot f_{uk}$				
Rupture mixte par extraction et par cône béton pour une durée de vie de 50 ans								
Résistance caractéristique dans du béton fissuré C20/25 dans des trous percés par percussion et dans des trous percés par percussion avec le foret aspirant TE-CD ou TE-YD et dans des trous percés par carottage diamant avec utilisation de l'outil abrasif Hilti TE-YRT								
Classe de température I: 40°C/24°C	$\tau_{Rk,C1}$ [N/mm ²]	8,2	10,1	10,5	9,7	8,9	9,0	8,5
Classe de température II: 55°C/43°C	$\tau_{Rk,C1}$ [N/mm ²]	7,3	8,3	8,1	8,2	7,9	7,5	7,0
Classe de température III: 75°C/55°C	$\tau_{Rk,C1}$ [N/mm ²]	3,2	3,2	3,3	2,9	3,0	3,0	2,5
Rupture mixte par extraction et par cône béton pour une durée de vie de 100 ans								
Résistance caractéristique dans du béton fissuré C20/25 dans des trous percés par percussion et dans des trous percés par percussion avec le foret aspirant TE-CD ou TE-YD et dans des trous percés par carottage diamant avec utilisation de l'outil abrasif Hilti TE-YRT								
Classe de température I: 40°C/24°C	$\tau_{Rk,100,C1}$ [N/mm ²]	7,3	7,8	8,1	7,8	7,4	7,5	6,5
Classe de température II: 55°C/43°C	$\tau_{Rk,100,C1}$ [N/mm ²]	6,4	6,9	7,1	6,8	6,9	6,5	6,0
Classe de température III: 75°C/55°C	$\tau_{Rk,100,C1}$ [N/mm ²]	3,2	3,2	3,3	2,9	3,0	3,0	2,5
Influence des facteurs ψ sur la contrainte d'adhérence $\tau_{Rk,C1}$ et $\tau_{Rk,100,C1}$								
Influence de la résistance du béton								
Classe de température I à III:	ψ_c [-]	1,0						

Injection system Hilti HIT-RE 500 V4

Performances

Caractéristiques essentielles sous charge de traction pour la performance sismique de catégorie C1 dans le béton

Annexe C29

Tableau C25: Caractéristiques essentielles pour les douilles taraudées HIS-(R)N sous charge de traction pour la catégorie sismique C1 dans le béton

HIS-(R)N		M8	M10	M12	M16	M20	
Pour une durée de vie de 50 et 100 ans							
Rupture de l'acier							
Résistance caractéristique HIS-N	$N_{Rk,s,C1}$ [kN]	25	46	67	125	116	
Résistance caractéristique HIS-RN	$N_{Rk,s,C1}$ [kN]	26	41	59	110	166	
Rupture mixte par extraction et par cône béton pour une durée de vie de 50 ans							
Résistance caractéristique dans du béton fissuré C20/25 dans des trous percés par percussion et dans des trous percés par percussion avec le foret aspirant TE-CD ou TE-YD et dans des trous percés par carottage diamant avec utilisation de l'outil abrasif Hilti TE-YRT							
Classe de température I: 40°C/24°C	$\tau_{Rk,C1}$ [N/mm ²]	8,4	8,6	8,7	9,0	9,0	
Classe de température II: 55°C/43°C	$\tau_{Rk,C1}$ [N/mm ²]	7,4	7,6	7,8	8,0	8,0	
Classe de température III: 75°C/55°C	$\tau_{Rk,C1}$ [N/mm ²]	2,8	3,3	3,4	3,5	3,5	
Rupture mixte par extraction et par cône béton pour une durée de vie de 100 ans							
Résistance caractéristique dans du béton fissuré C20/25 dans des trous percés par percussion et dans des trous percés par percussion avec le foret aspirant TE-CD ou TE-YD et dans des trous percés par carottage diamant avec utilisation de l'outil abrasif Hilti TE-YRT						Diamètre de la barre d'armature	
Classe de température I: 40°C/24°C	$\tau_{Rk,100,C1}$ [N/mm ²]	6,5	6,7	6,8	7,0		7,0
Classe de température II: 55°C/43°C	$\tau_{Rk,100,C1}$ [N/mm ²]	5,6	6,2	6,3	6,5		6,5
Classe de température III: 75°C/55°C	$\tau_{Rk,100,C1}$ [N/mm ²]	2,8	2,9	2,9	3,0		3,0
Influence des facteurs ψ sur la contrainte d'adhérence $\tau_{Rk,C1}$ et $\tau_{Rk,100,C1}$							
Influence de la résistance du béton							
Classe de température I à III:	ψ_c [-]	1,0					

Injection system Hilti HIT-RE 500 V4

Performances

Caractéristiques essentielles sous charge de traction pour les performances sismiques de catégorie C1 dans le béton

Annexe C30

Tableau C26: Caractéristiques essentielles pour les douilles taraudées HIS-(R)N sous charge de traction pour la catégorie sismique C1 dans le béton

HIS-(R)N, taille		[in.]	3/8	1/2	5/8	3/4
Pour une durée de vie de 50 et 100 ans						
Rupture de l'acier						
Résistance caractéristique HIS-N Vis selon SAE J429 Classe 5 ou ASTM A325 (1/2 in. à 3/4 in.)	$N_{Rk,s,C1}$	[kN]	41	76	121	130
Résistance caractéristique HIS-N Vis selon ASTM A193 Classe B7	$N_{Rk,s,C1}$	[kN]	43	77	128	130
Résistance caractéristique HIS-RN Vis selon ASTM A193 Classe B8M (AISI 316)	$N_{Rk,s,C1}$	[kN]	38	110	182	185
Résistance caractéristique HIS-RN Vis selon ASTM A193 Classe B8T (AISI 321)	$N_{Rk,s,C1}$	[kN]	43	110	182	185
Rupture mixte par extraction et par cône béton pour une durée de vie de 50 ans						
Résistance caractéristique dans du béton fissuré C20/25 dans des trous percés par percussion et dans des trous percés par percussion avec le foret aspirant TE-CD ou TE-YD et dans des trous percés par carottage diamant avec utilisation de l'outil abrasif Hilti TE-YRT						
Classe de température I: 40°C/24°C	$\tau_{Rk,C1}$	[N/mm ²]	8,6	8,7	9,0	9,0
Classe de température II: 55°C/43°C	$\tau_{Rk,C1}$	[N/mm ²]	7,6	7,8	8,0	8,0
Classe de température III: 75°C/55°C	$\tau_{Rk,C1}$	[N/mm ²]	2,9	2,9	3,0	3,0
Rupture mixte par extraction et par cône béton pour une durée de vie de 100 ans						
Résistance caractéristique dans du béton fissuré C20/25 dans des trous percés par percussion et dans des trous percés par percussion avec le foret aspirant TE-CD ou TE-YD et dans des trous percés par carottage diamant avec utilisation de l'outil abrasif Hilti TE-YRT						
Classe de température I: 40°C/24°C	$\tau_{Rk,100,C1}$	[N/mm ²]	6,7	6,8	7,0	7,0
Classe de température II: 55°C/43°C	$\tau_{Rk,100,C1}$	[N/mm ²]	6,2	6,3	6,5	6,5
Classe de température III: 75°C/55°C	$\tau_{Rk,100,C1}$	[N/mm ²]	2,9	2,9	3,0	3,0
Influence des facteurs ψ sur la contrainte d'adhérence $\tau_{Rk,C1}$ et $\tau_{Rk,100,C1}$						
Influence de la résistance du béton						
Classe de température I à III:	ψ_c	[-]	1,0			

Injection system Hilti HIT-RE 500 V4

Performances

Caractéristiques essentielles sous charge de traction pour les performances sismiques de catégorie C1 dans le béton

Annexe C31

Tableau C27: Caractéristiques essentielles pour Hilti tension anchor HZA / HZA-R sous charge de traction pour la catégorie sismique C1 dans le béton

HZA / HZA-R			M12	M16	M20	M24	M27	
Diamètre de la barre d'armature	ϕ	[mm]	12	16	20	25	28	
Pour une durée de vie de 50 et 100 ans								
Rupture de l'acier								
Résistance caractéristique HZA	$N_{Rk,s,C1}$	[kN]	46	86	135	194	253	
Résistance caractéristique HZA-R	$N_{Rk,s,C1}$	[kN]	62	111	173	248	¹⁾	
Rupture mixte par extraction et par cône béton pour une durée de vie de 50 ans								
Résistance caractéristique dans du béton fissuré C20/25 dans des trous percés par percussion et dans des trous percés par percussion avec le foret aspirant TE-CD ou TE-YD et dans des trous percés par carottage diamant avec utilisation de l'outil abrasif Hilti TE-YRT								
Classe de température I: 40°C/24°C	$\tau_{Rk,C1}$	[N/mm ²]	11,0	11,4	11,6	10,9	11,0	
Classe de température II: 55°C/43°C	$\tau_{Rk,C1}$	[N/mm ²]	9,2	9,5	9,7	9,4	9,5	
Classe de température III: 75°C/55°C	$\tau_{Rk,C1}$	[N/mm ²]	3,7	3,8	3,4	3,5	3,5	
Rupture mixte par extraction et par cône béton pour une durée de vie de 100 ans								
Résistance caractéristique dans du béton fissuré C20/25 dans des trous percés par percussion et dans des trous percés par percussion avec le foret aspirant TE-CD ou TE-YD et dans des trous percés par carottage diamant avec utilisation de l'outil abrasif Hilti TE-YRT								
Classe de température I: 40°C/24°C	$\tau_{Rk,100,C1}$	[N/mm ²]	9,2	9,0	9,2	8,9	9,0	
Classe de température II: 55°C/43°C	$\tau_{Rk,100,C1}$	[N/mm ²]	8,3	8,1	8,2	7,9	8,0	
Classe de température III: 75°C/55°C	$\tau_{Rk,100,C1}$	[N/mm ²]	3,7	3,8	3,4	3,5	3,5	
Influence des facteurs ψ sur la contrainte d'adhérence $\tau_{Rk,C1}$ et $\tau_{Rk,100,C1}$								
Influence de la résistance du béton								
Classe de température I à III:	ψ_c	[-]						1,0

¹⁾ Aucune performance évaluée.

Injection system Hilti HIT-RE 500 V4

Performances

Caractéristiques essentielles sous charge de traction pour les performances sismiques de catégorie C1 dans le béton

Annexe C32

Tableau C28: Caractéristiques essentielles pour les barres d'armature (rebars) sous charge de traction pour la catégorie sismique C1 dans le béton

Barre d'armature	Barre d'armature (rebar)	φ10	φ12	φ14	φ16	φ18	φ20	φ24	φ25	φ28	φ30	φ32	
Pour une durée de vie de 50 et 100 ans													
Rupture de l'acier													
Résistance caractéristique	$N_{Rk,s,C1}$	[kN]	$A_s \cdot f_{uk}^{1)}$										
Résistance caractéristique Rebar B500B selon la DIN 488:2009-08 ²⁾	$N_{Rk,s,C1}$	[kN]	43	62	85	111	140	173	249	270	339	389	442
Rupture mixte par extraction et par cône béton pour une durée de vie de 50 ans													
Résistance caractéristique dans du béton fissuré C20/25 dans des trous percés par percussion et dans des trous percés par percussion avec le foret aspirant TE-CD ou TE-YD et dans des trous percés par carottage diamant avec utilisation de l'outil abrasif Hilti TE-YRT													
Classe de température I: 40°C/24°C	$\tau_{Rk,C1}$	[N/mm ²]	9,1	11,0	11,0	11,4	11,5	11,6	10,8	10,9	11,0	11,0	11,0
Classe de température II: 55°C/43°C	$\tau_{Rk,C1}$	[N/mm ²]	7,7	9,2	9,2	9,5	9,6	9,7	9,3	9,4	9,5	9,5	9,0
Classe de température III: 75°C/55°C	$\tau_{Rk,C1}$	[N/mm ²]	3,6	3,7	3,7	3,8	3,8	3,4	3,4	3,5	3,5	3,5	3,5
Rupture mixte par extraction et par cône béton pour une durée de vie de 100 ans													
Résistance caractéristique dans du béton fissuré C20/25 dans des trous percés par percussion et dans des trous percés par percussion avec le foret aspirant TE-CD ou TE-YD et dans des trous percés par carottage diamant avec utilisation de l'outil abrasif Hilti TE-YRT													
Classe de température I: 40°C/24°C	$\tau_{Rk,100,C1}$	[N/mm ²]	8,2	9,2	9,2	9,0	9,1	9,2	8,8	8,9	9,0	9,0	9,0
Classe de température II: 55°C/43°C	$\tau_{Rk,100,C1}$	[N/mm ²]	7,3	8,3	8,3	8,1	8,2	8,2	7,8	7,9	8,0	8,0	8,0
Classe de température III: 75°C/55°C	$\tau_{Rk,100,C1}$	[N/mm ²]	3,6	3,7	3,7	3,8	3,8	3,4	3,4	3,5	3,5	3,5	3,5
Influence des facteurs ψ sur la contrainte d'adhérence $\tau_{Rk,C1}$ et $\tau_{Rk,100,C1}$													
Influence de la résistance du béton													
Classe de température I à III:	ψ_c	[-]	1,0										

1) f_{uk} selon les spécifications de la barre d'armature.

2) Les valeurs doivent être calculées selon EAD 330499-01, Eq. 2.1, si les barres d'armature ne répondent pas aux prérequis de DIN 488.

Injection system Hilti HIT-RE 500 V4

Performances

Caractéristiques essentielles sous charge de traction pour les performances sismiques de catégorie C1 dans le béton

Annexe C33

Tableau C29: Caractéristiques essentielles pour les tiges filetées métriques selon l'Annexe A sous charge de cisaillements pour la catégorie sismique C1 dans le béton

Tige filetée, HAS-U-..., HIT-V-..., AM...8.8			M8	M10	M12	M16	M20	M24	M27	M30	
Pour une durée de vie de 50 et 100 ans											
Facteur pour le jeu annulaire sans Hilti Filling Set	α_{gap}	[-]					0,5				
Facteur pour le jeu annulaire avec Hilti Filling Set	α_{gap}	[-]					1,0				
Rupture de l'acier sans bras de levier											
Résistance caractéristique HAS 5.8, HAS-U-5.8, HIT-V-5.8	$V_{Rk,s,C1}$	[kN]					$0,6 \cdot A_s \cdot f_{uk}$				
Résistance caractéristique HAS 8.8, HAS-U-8.8, HIT-V-8.8, AM...8.8	$V_{Rk,s,C1}$	[kN]					$0,5 \cdot A_s \cdot f_{uk}$				
Résistance caractéristique Tige filetée standard	$V_{Rk,s,C1}$	[kN]					$0,35 \cdot A_s \cdot f_{uk}$				

Tableau C30: Caractéristiques essentielles pour les tiges filetées impériales selon l'Annexe A sous charge de cisaillements pour la catégorie sismique C1 dans le béton

Tige filetée, HAS-..., HIT-V, taille [in.]			3/8	1/2	5/8	3/4	7/8	1	1 1/4		
Pour une durée de vie de 50 et 100 ans											
Facteur pour le jeu annulaire sans Hilti Filling Set	α_{gap}	202 2B[-]					0,5				
Rupture de l'acier sans bras de levier											
Résistance caractéristique HAS-..., HIT-V	$V_{Rk,s,C1}$	[kN]					$0,5 \cdot A_s \cdot f_{uk}$				
Résistance caractéristique Tige filetée standard	$V_{Rk,s,C1}$	[kN]					$0,35 \cdot A_s \cdot f_{uk}$				

Tableau C31: Caractéristiques essentielles pour les douilles taraudées HIS-(R)N sous charge de cisaillement pour la catégorie sismique C1 dans le béton

HIS-(R)N			M8	M10	M12	M16	M20	
Pour une durée de vie de 50 et 100 ans								
Facteur pour le jeu annulaire sans Hilti Filling Set	α_{gap}	[-]						0,5
Facteur pour le jeu annulaire avec Hilti Filling Set	α_{gap}	[-]						1,0
Rupture de l'acier sans bras de levier								
Résistance caractéristique HIS-N avec une vis 8.8	$V_{Rk,s,C1}$	[kN]	9,0	16	27	41	39	
Résistance caractéristique HIS-RN avec une vis de classe 70	$V_{Rk,s,C1}$	[kN]	9,0	14	21	39	58	

Injection system Hilti HIT-RE 500 V4

Performances

Caractéristiques essentielles sous charge de cisaillement pour les performances sismiques de catégorie C1 dans le béton

Annexe C34

Tableau C32: Caractéristiques essentielles pour les douilles taraudées HIS-(R)N sous charge de cisaillement pour la catégorie sismique C1 dans le béton

HIS-(R)N, taille [in.]		3/8	1/2	5/8	3/4
Pour une durée de vie de 50 et 100 ans					
Facteur pour le jeu annulaire sans Hilti Filling Set	α_{gap} [-]	0,5			
Rupture de l'acier sans bras de levier					
Résistance caractéristique HIS-N Vis selon SAE J429 Classe 5 ou ASTM A325 (1/2 in. à 3/4 in.)	$V_{Rk,s,C1}$ [kN]	14	27	42	45
Résistance caractéristique HIS-N Vis selon ASTM A193 Classe B7	$V_{Rk,s,C1}$ [kN]	15	28	44	45
Résistance caractéristique HIS-RN Vis selon ASTM A193 Classe B8M (AISI 316)	$V_{Rk,s,C1}$ [kN]	13	24	39	65
Résistance caractéristique HIS-RN Vis selon ASTM A193 Classe B8T (AISI 321)	$V_{Rk,s,C1}$ [kN]	15	28	44	65

Tableau C33: Caractéristiques essentielles pour Hilti tension anchor HZA / HZA-R sous charge de cisaillement pour la catégorie sismique C1 dans le béton

HZA / HZA-R		M12	M16	M20	M24	M27
Pour une durée de vie de 50 et 100 ans						
Facteur pour le jeu annulaire sans Hilti Filling Set	α_{gap} [-]	0,5				
Rupture de l'acier sans bras de levier						
Résistance caractéristique HZA	$V_{Rk,s,C1}$ [kN]	23	43	67	97	126
Résistance caractéristique HZA-R	$V_{Rk,s,C1}$ [kN]	31	55	86	124	¹⁾

¹⁾ Aucune performance évaluée.

Tableau C34: Caractéristiques essentielles pour les barres d'armature (rebars) sous charge de cisaillements pour la catégorie sismique C1 dans le béton

Barre d'armature (rebar)		$\phi 10$	$\phi 12$	$\phi 14$	$\phi 16$	$\phi 18$	$\phi 20$	$\phi 24$	$\phi 25$	$\phi 28$	$\phi 30$	$\phi 32$
Pour une durée de vie de 50 et 100 ans												
Rupture de l'acier sans bras de levier												
Résistance caractéristique	$V_{Rk,s,C1}$ [kN]	$0,35 \cdot A_s \cdot f_{uk}^{1)}$										
Résistance caractéristique Rebar B500B selon la DIN 488:2009-08 ²⁾	$V_{Rk,s,C1}$ [kN]	15	22	30	39	49	60	87	95	118	136	155

¹⁾ f_{uk} selon les spécifications de la barre d'armature.

²⁾ Les valeurs doivent être calculées selon EAD 330499-01, Eq. 2.1, si les barres d'armature ne répondent pas aux prérequis de DIN 488.

Injection system Hilti HIT-RE 500 V4

Performances

Caractéristiques essentielles sous charges de cisaillement pour les performances sismiques de catégorie C1 dans le béton

Annexe C35

Tableau C35: Caractéristiques essentielles pour les tiges filetées métriques selon l'Annexe A sous charge de traction pour la catégorie sismique C2 dans le béton

Tige filetée métrique selon l'Annexe A	M12	M16	M20	M24	M27	M30	
Pour une durée de vie de 50 et 100 ans							
Rupture de l'acier							
Résistance caractéristique HAS (8.8, 8.8 HDG, A4), HAS-U (8.8, 8.8 HDG, A4, HCR), HIT-V (-8.8, -8.8F, -R, -HCR), AM (8.8, 8.8 HDG), Tige filetée standard (classe 8.8, A4, HCR)	N _{rk,s,C2} [kN]		A _s · f _{uk}				
Rupture mixte par extraction et par cône béton pour une durée de vie de 50 ans							
Résistance caractéristique dans du béton fissuré C20/25 dans des trous percés par percussion et dans des trous percés par percussion avec le foret aspirant TE-CD ou TE-YD							
Classe de température I: 40°C/24°C	τ _{rk,C2} [N/mm ²]	3,7	6,5	5,8	6,0	5,0	5,2
Classe de température II: 55°C/43°C	τ _{rk,C2} [N/mm ²]	3,1	5,3	4,8	5,0	4,2	4,3
Classe de température III: 75°C/55°C	τ _{rk,C2} [N/mm ²]	1,2	2,1	1,9	1,9	1,6	1,7
Rupture mixte par extraction et par cône béton pour une durée de vie de 100 ans							
Résistance caractéristique dans du béton fissuré C20/25 dans des trous percés par percussion et dans des trous percés par percussion avec le foret aspirant TE-CD ou TE-YD							
Classe de température I: 40°C/24°C	τ _{rk,100,C2} [N/mm ²]	3,7	6,5	5,8	6,0	5,0	5,2
Classe de température II: 55°C/43°C	τ _{rk,100,C2} [N/mm ²]	3,0	5,3	4,8	4,9	4,1	4,3
Classe de température III: 75°C/55°C	τ _{rk,100,C2} [N/mm ²]	1,2	2,1	1,9	1,9	1,6	1,7
Influence des facteurs ψ sur la contrainte d'adhérence τ_{rk,C2} et τ_{rk,100,C2}							
Influence de la résistance du béton							
Classe de température I à III:	ψ _c [-]						1,0

Injection system Hilti HIT-RE 500 V4

Performances

Caractéristiques essentielles pour les performances sismiques de catégorie C2 dans le béton

Annexe C36

Tableau C36: Caractéristiques essentielles pour les tiges filetées métriques selon l'Annexe A sous charge de cisaillements pour la catégorie sismique C2 dans le béton

Tige filetée métrique selon l'Annexe A	M12	M16	M20	M24	M27	M30
Pour une durée de vie de 50 et 100 ans						
Facteur pour le jeu annulaire sans Hilti Filling Set α_{gap} [-]	0,5					
Facteur pour le jeu annulaire sans Hilti Filling Set α_{gap} [-]	1,0					
Rupture de l'acier sans bras de levier avec Hilti Filling Set						
Résistance caractéristique HAS 8.8, HAS-U 8.8, HIT-V-8.8, AM 8.8 $V_{Rk,s,C2}$ [kN]	28	46	77	103	1)	
Rupture de l'acier sans bras de levier sans Hilti Filling Set						
Résistance caractéristique HAS 8.8, HAS-U 8.8, HIT-V-8.8, AM 8.8 $V_{Rk,s,C2}$ [kN]	24	40	71	90	121	135
Résistance caractéristique HAS-U 8.8 HDG, HIT-V-8.8F, HAS 8.8, AM HDG 8.8 $V_{Rk,s,C2}$ [kN]	18	30	46	66	1)	
Résistance caractéristique HAS A4, HAS-U A4, HIT-V-R $V_{Rk,s,C2}$ [kN]	21	35	62	79	76	84
Résistance caractéristique HAS-U HCR, HIT-V-HCR $V_{Rk,s,C2}$ [kN]	24	40	71	79	106	118
Résistance caractéristique Tige filetée standard 8.8 $V_{Rk,s,C2}$ [kN]	17	28	50	63	85	95
Résistance caractéristique Tige filetée standard A4 $V_{Rk,s,C2}$ [kN]	15	25	43	55	53	59
Résistance caractéristique Tige filetée standard HCR $V_{Rk,s,C2}$ [kN]	17	28	50	55	74	83

1) Aucune performance évaluée.

Injection system Hilti HIT-RE 500 V4

Performances

Caractéristiques essentielles pour les performances sismiques de catégorie C2 dans le béton

Annexe C37

Tableau C37: Déplacements pour les tiges filetées métriques selon l'Annexe A sous charge de traction pour la catégorie sismique C2 dans le béton

Tige filetée métrique selon l'Annexe A		M12	M16	M20	M24	M27	M30
Tige filetée, HAS 8.8, HAS-U-..., HIT-V-..., AM...8.8	$\delta_{N,C2(DLS)}$ [mm]	0,2	0,5	0,5	0,4	0,4	0,5
	$\delta_{N,C2(ULS)}$ [mm]	0,6	1,2	0,9	0,8	1,0	0,9

1) Aucune performance évaluée.

Tableau C38: Déplacements pour les tiges filetées métriques selon l'Annexe A sous charge de cisaillements pour la catégorie sismique C2 dans le béton

Tige filetée métrique selon l'Annexe A		M12	M16	M20	M24	M27	M30
Installation avec le Hilti Filling Set							
HAS 8.8, HAS-U 8.8, HIT-V 8.8, AM 8.8	$\delta_{V,C2(DLS)}$ [mm]	0,6	1,2	1,4	1,1	1)	
	$\delta_{V,C2(ULS)}$ [mm]	3,1	3,2	3,7	2,6	1)	
Installation sans le Hilti Filling Set							
Tige filetée, HAS..., HAS-U-..., HIT-V-..., AM 8.8	$\delta_{V,C2(DLS)}$ [mm]	1,9	3,2	2,5	3,5	3,0	1,9
	$\delta_{V,C2(ULS)}$ [mm]	4,4	9,2	7,1	10,2	7,2	6,3
HAS 8.8 HDG, HAS-U 8.8 HDG, HIT-V-F 8.8, AM HDG 8.8	$\delta_{V,C2(DLS)}$ [mm]	2,2	2,3	3,8	3,4	1)	
	$\delta_{V,C2(ULS)}$ [mm]	4,1	4,3	9,1	8,4	1)	

1) Aucune performance évaluée.

Injection system Hilti HIT-RE 500 V4

Performances

Déplacements pour la catégorie sismique C2 et déplacements

Annexe C38

Contrainte d'adhérence caractéristique d'une fixation unique $\tau_{Rk,fi,p}(\theta)$ pour des classes de béton de C20/25 à C50/60 pour toutes méthodes de perçage sous exposition au feu²

La contrainte d'adhérence caractéristique d'une fixation unique sous exposition au feu $\tau_{Rk,fi,p}$ pour une température donnée (θ) doit être calculée en utilisant les équations suivantes:

$$\tau_{Rk,fi,p}(\theta) = k_{fi,p}(\theta) \cdot \tau_{Rk,cr,C20/25}$$

Où: $\theta \leq \theta_{max}$: $k_{fi,p}(\theta) = k_{fi,p,100y}(\theta) = 39,83 \cdot \theta^{-1,266} \leq 1,0$

et $\theta < \theta_{max}$: $k_{fi,p}(\theta) = k_{fi,p,100y}(\theta) = 0,0$

$\theta_{max} = 305^{\circ}C$

$\tau_{Rk,fi,p}$ = contrainte d'adhérence caractéristique dans du béton fissuré sous exposition au feu pour une température donnée (θ)

$k_{fi,p}(\theta)$ = facteur de réduction pour la contrainte d'adhérence sous exposition au feu

$\tau_{Rk,cr,C20/25}$ = contrainte d'adhérence caractéristique dans du béton fissuré de classe de résistance C20/25 pour une plage de températures données

Figure C1: Facteur de réduction $k_{fi,p}(\theta)$

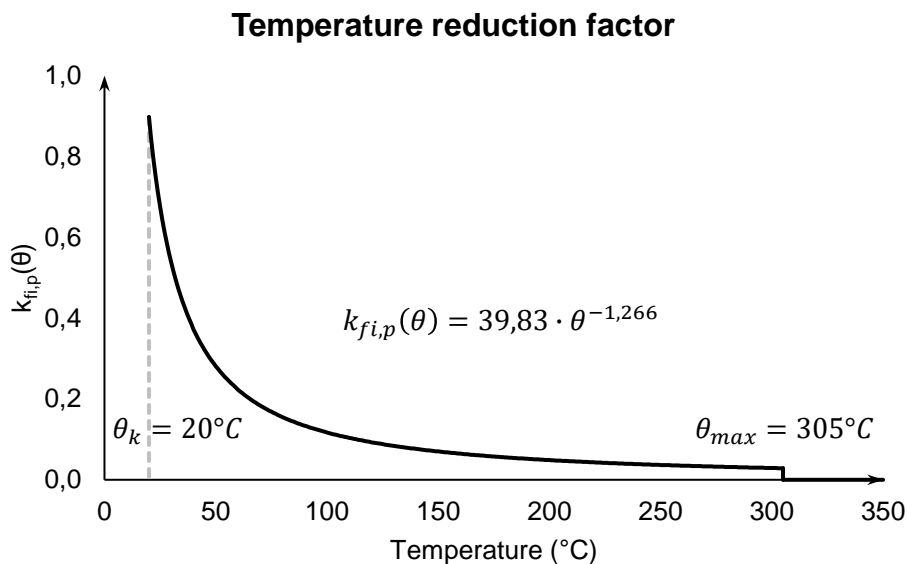

² Se référer à l'Annexe B1 pour la résistance caractéristique d'une fixation, un groupe de fixations et les fixations sous effort de traction pour un groupe de fixations dans le cas d'une rupture combinée par extraction (pull-out) et rupture du béton sous exposition au feu $N_{Rk,p,fi}$

Injection system Hilti HIT-RE 500 V4

Performances

Facteur de réduction pour une rupture par extraction (pull-out) pour une fixation unique sous exposition au feu

Annexe C39

Tableau C4: Resistance caractéristique sous charge de traction dans le cas d'une rupture de l'acier sous exposition au feu

Taille de la fixation		M8	M10	M12	M16	M20	M24	M27	M30
HAS 5.8, 5.8 HDG	$N_{Rk,s,fi(30)}$ [kN]	1,04	1,77	2,76	5,15	8,04	11,58	15,05	18,40
HAS 8.8, 8.8 HDG	$N_{Rk,s,fi(60)}$ [kN]	0,81	1,34	2,03	3,79	5,91	8,51	11,07	13,53
HAS-U 5.8, 5.8 HDG	$N_{Rk,s,fi(90)}$ [kN]	0,59	0,91	1,30	2,42	3,78	5,45	7,09	8,66
HAS-U 8.8, 8.8 HDG	$N_{Rk,s,fi(120)}$ [kN]	0,47	0,70	0,94	1,74	2,72	3,92	5,09	6,22
HAS A4	$N_{Rk,s,fi(30)}$ [kN]	2,67	4,85	7,94	14,78	23,06	33,23	43,21	52,81
HAS-U A4-70	$N_{Rk,s,fi(60)}$ [kN]	1,93	3,44	5,57	10,37	16,18	23,32	30,32	37,06
HAS-U HCR	$N_{Rk,s,fi(90)}$ [kN]	1,18	2,03	3,20	5,96	9,30	13,40	17,43	21,30
	$N_{Rk,s,fi(120)}$ [kN]	0,80	1,33	2,02	3,76	5,86	8,44	10,98	13,42

Tableau C5: Resistance caractéristique sous charge de traction dans le cas d'une rupture de l'acier sous exposition au feu

Taille de la fixation		[in.]	3/8	1/2	5/8	3/4	7/8	1	1 1/4
HAS-E-55 HAS-B-105 (HDG)	$N_{Rk,s,fi(30)}$ [kN]		1,50	3,00	4,78	7,08	9,77	12,82	20,50
	$N_{Rk,s,fi(60)}$ [kN]		1,15	2,21	3,52	5,20	7,18	9,42	15,08
	$N_{Rk,s,fi(90)}$ [kN]		0,79	1,41	2,25	3,33	4,60	6,03	9,65
	$N_{Rk,s,fi(120)}$ [kN]		0,61	1,02	1,62	2,39	3,31	4,34	6,94

Tableau C6: Resistance caractéristique sous charge de traction dans le cas d'une rupture par cône béton ou par fendage sous exposition au feu

Taille de la fixation		M8, M10, M12, M16, M20, M24, M27, M30 [in.] 3/8, 1/2, 5/8, 3/4, 7/8, 1, 1 1/4
HAS 5.8, 5.8 HDG	$N_{Rk,c,fi}^0$ [kN]	$\frac{h_{ef}}{200} \cdot N_{Rk,c}^0 \leq N_{Rk,c}^0$
HAS 8.8, 8.8 HDG		
HAS-U 5.8, 5.8 HDG		
HAS-U 8.8, 8.8 HDG		
HIT-V 5.8, 5.8F	$N_{Rk,c,fi(90)}$ [kN]	
HIT-V 8.8, 8.8F		
HAS-E-55	$N_{Rk,c,fi(120)}$ [kN]	$0,8 \cdot \frac{h_{ef}}{200} \cdot N_{Rk,c}^0 \leq N_{Rk,c}^0$
HAS-B-105 (HDG)		
HAS A4		
HAS-U A4-70		
HAS-U HCR		
Espacement caractéristique	$S_{cr,N,fi}$ [mm]	$4h_{ef}$
Distance au bord caractéristiques	$C_{cr,N,fi}$ [mm]	$2h_{ef}$

Injection system Hilti HIT-RE 500 V4

Performance

Resistance caractéristique sous charge de traction dans le cas d'une rupture par cône béton ou de l'acier sous exposition au feu

Annexe C40

Tableau C7: Resistance caractéristique sous charge de cisaillement dans le cas d'une rupture de l'acier sous exposition au feu

Taille de la fixation		M8	M10	M12	M16	M20	M24	M27	M30
HAS 5.8, 5.8 HDG HAS 8.8, 8.8 HDG HAS-U 5.8, 5.8 HDG HAS-U 8.8, 8.8 HDG HIT-V 5.8, 5.8F HIT-V 8.8, 8.8F	$V_{Rk,s,fi(30)}$ [kN]	1,04	1,77	2,76	5,15	8,04	11,58	15,05	18,40
	$V_{Rk,s,fi(60)}$ [kN]	0,81	1,34	2,03	3,79	5,91	8,51	11,07	13,53
	$V_{Rk,s,fi(90)}$ [kN]	0,59	0,91	1,30	2,42	3,78	5,45	7,09	8,66
	$V_{Rk,s,fi(120)}$ [kN]	0,47	0,70	0,94	1,74	2,72	3,92	5,09	6,22
	$M_{Rk,s,fi(30)}^0$ [Nm]	1063	2286	4296	10920	21287	36816	54588	73760
	$M_{Rk,s,fi(60)}^0$ [Nm]	832	1731	3159	8029	15653	27072	40140	54238
	$M_{Rk,s,fi(90)}^0$ [Nm]	601	1176	2022	5139	10019	17328	25692	34716
	$M_{Rk,s,fi(120)}^0$ [Nm]	485	899	1453	3694	7202	12456	18468	24955
HAS A4 HAS-U A4-70 HAS-U HCR	$V_{Rk,s,fi(30)}$ [kN]	2,67	4,85	7,94	14,78	23,06	33,23	43,21	52,81
	$V_{Rk,s,fi(60)}$ [kN]	1,93	3,44	5,57	10,37	16,18	23,32	30,32	37,06
	$V_{Rk,s,fi(90)}$ [kN]	1,18	2,03	3,20	5,96	9,30	13,40	17,43	21,30
	$V_{Rk,s,fi(120)}$ [kN]	0,80	1,33	2,02	3,76	5,86	8,44	10,98	13,42
	$M_{Rk,s,fi(30)}^0$ [Nm]	2739	6251	12332	31344	61102	105674	156684	211715
	$M_{Rk,s,fi(60)}^0$ [Nm]	1971	4435	8653	21992	42872	74146	109938	148550
	$M_{Rk,s,fi(90)}^0$ [Nm]	1204	2620	4973	12641	24642	42619	63191	85386
	$M_{Rk,s,fi(120)}^0$ [Nm]	820	1712	3134	7965	15528	26855	39818	53803

Tableau C8: Resistance caractéristique sous charge de cisaillement dans le cas d'une rupture de l'acier sous exposition au feu

Taille de la fixation		[in.]	3/8	1/2	5/8	3/4	7/8	1	1 1/4
HAS-E-55 HAS-B-105 (HDG)	$V_{Rk,s,fi(30)}$ [kN]		1,50	3,00	4,78	7,08	9,77	12,82	20,50
	$V_{Rk,s,fi(60)}$ [kN]		1,15	2,21	3,52	5,20	7,18	9,42	15,08
	$V_{Rk,s,fi(90)}$ [kN]		0,79	1,41	2,25	3,33	4,60	6,03	9,65
	$V_{Rk,s,fi(120)}$ [kN]		0,61	1,02	1,62	2,39	3,31	4,34	6,94
	$M_{Rk,s,fi(30)}^0$ [Nm]		1962	4452	9772	17597	28541	42885	86777
	$M_{Rk,s,fi(60)}^0$ [Nm]		1443	3397	7186	12940	20987	31535	63810
	$M_{Rk,s,fi(90)}^0$ [Nm]		923	2342	4599	8282	13433	20184	40843
	$M_{Rk,s,fi(120)}^0$ [Nm]		664	1815	3306	5953	9656	14509	29359

Injection system Hilti HIT-RE 500 V4

Performance

Resistance caractéristique sous charge de cisaillement dans le cas d'une rupture de l'acier sous exposition au feu

Annexe C41

Tableau C9: Resistance caractéristique sous charge de cisaillement par effet levier sous exposition au feu

Taille de la fixation		M8, M10, M12, M16, M20, M24, M27, M30 [in.] 3/8, 1/2, 5/8, 3/4, 7/8, 1, 1 1/4
HAS 5.8, 5.8 HDG HAS 8.8, 8.8 HDG HAS-U 5.8, 5.8 HDG HAS-U 8.8, 8.8 HDG HIT-V 5.8, 5.8F HIT-V 8.8, 8.8F	$V_{Rk,cp,fi(30)}$ [kN] $V_{Rk,cp,fi(60)}$ [kN]	$k_8 \cdot N_{Rk,c,fi(90)}$
HAS-E-55 HAS-B-105 (HDG) HAS A4 HAS-U A4-70	$V_{Rk,cp,fi(90)}$ [kN]	
HAS-U HCR	$V_{Rk,cp,fi(120)}$ [kN]	$k_8 \cdot N_{Rk,c,fi(120)}$

Tableau C10: Resistance caractéristique sous charge de cisaillement par rupture du béton en bord de dalle sous exposition au feu

Taille de la fixation		M8, M10, M12, M16, M20, M24, M27, M30 [in.] 3/8, 1/2, 5/8, 3/4, 7/8, 1, 1 1/4
HAS 5.8, 5.8 HDG HAS 8.8, 8.8 HDG HAS-U 5.8, 5.8 HDG HAS-U 8.8, 8.8 HDG HIT-V 5.8, 5.8F HIT-V 8.8, 8.8F	$V_{Rk,c,fi(30)}$ [kN] $V_{Rk,c,fi(60)}$ [kN]	$0,25 \cdot V_{Rk,c}^0$
HAS-E-55 HAS-B-105 (HDG) HAS A4 HAS-U A4-70	$V_{Rk,c,fi(90)}$ [kN]	
HAS-U HCR	$V_{Rk,c,fi(120)}$ [kN]	$0,20 \cdot V_{Rk,c}^0$

Injection system Hilti HIT-RE 500 V4

Performance

Resistance caractéristique sous charge de cisaillement dans le cas d'une rupture par effet levier (pry-out) ou du bord de dalle sous exposition au feu

Annexe C42

Centre Scientifique et Technique du Bâtiment

84 avenue Jean Jaurès
CHAMPS-SUR-MARNE
F-77447 Marne-la-Vallée Cedex 2
Tél. : (33) 01 64 68 82 82
Fax : (33) 01 60 05 70 37

Członek

EOTA

www.eota.eu

Upoważniona
zgodnie z Artykułem 29
Rozporządzenia
(Unii Europejskiej)
Nr 305/2011

Europejska Ocena Techniczna

ETA-20/0541 z 09.06.2023r.

Tłumaczenie angielskie przygotowane przez Centre Scientifique et Technique du Bâtiment – Wersja oryginalna w języku francuskim
Tłumaczenie z języka angielskiego na język polski przygotowano na zlecenie firmy Hilti (Poland) Sp. z o.o.

Część Ogólna

Jednostka Oceny Technicznej wydająca niniejszą Europejską Ocena Techniczną:

Centre Scientifique et Technique du Bâtiment (CSTB)

Nazwa handlowa:

System iniekcyjny Hilti HIT-RE 500 V4

Rodzina produktów:

Łącznik wklejany z prętem gwintowanym, prętem zbrojeniowym, tuleją z gwintem wewnętrznym HIS-(R)N oraz kotwą naprężeniową Hilti HZA(-R) do stosowania w betonie dla okresu eksploatacji 50 oraz 100 lat.

Producent:

Firma Hilti
Feldkircherstrasse 100
FL-9494 Schaan
Księstwo Liechtenstein

Zakłady produkcyjne:

Zakład produkcyjny Hilti

Niniejsza Europejska Ocena
Techniczna zawiera:

68 stron w tym 64 strony załączników, które stanowią integralną część składową niniejszej Oceny

Niniejsza Europejska Ocena
Techniczna została wydana
zgodnie z Rozporządzeniem
(U.E.) Nr 305/2011,
na podstawie
Niniejsza Ocena zastępuje:

EAD 330499-02-0601 wersja z września 2022r.

ETA-20/0541 wydaną 04.09.2021r.

Niniejsza Europejska Ocena Techniczna została wydana przez Jednostkę Oceny Technicznej w jej języku oficjalnym. Tłumaczenie niniejszej Europejskiej Oceny Technicznej na inne języki musi w pełni odpowiadać oryginalnie wydanemu dokumentowi i powinno być wyraźnie oznaczone jako takowe. Udostępnianie niniejszej Europejskiej Oceny Technicznej, włącznie z jej przesyłaniem za pomocą metod elektronicznych, jest dopuszczalne jedynie w całości. Kopiowanie części dokumentu może mieć miejsce, jednakże jedynie za pisemną zgodą wydającej go Jednostki Oceny Technicznej. Każde częściowe kopiowanie musi być wyraźnie oznaczone jako takowe. Niniejsza Europejska Ocena Techniczna może być wycofana przez wydającą ją Jednostkę Oceny Technicznej, szczególnie na podstawie informacji Komisji zgodnie z Artykułem 25(3) Rozporządzenia (U.E.) Nr 305/2011.

Część szczegółowa dokumentu

1 Opis techniczny produktu

System iniekcyjny Hilti HIT-RE 500 V4 jest kotwą wklejaną składającą się z ładunku foliowego z żywicą iniekcyjną Hilti HIT-RE 500 V4 oraz z elementu stalowego.

Przedmiotowymi stalowymi elementami są:

- pręt gwintowany Hilti HAS, HAS-U, Hilti HIT-V, pręt gwintowany metryczny Hilti AM 8.8 lub pręt gwintowany dostępny w handlu z podkładką i nakrętką sześciokątną w zakresie od M8 do M30 oraz od 3/8 cala do 1 1/4 cala,
- pręt zbrojeniowy w zakresie od ϕ 8 do ϕ 32.
- kotwa naprężeniowa Hilti HZA w zakresie od M12 do M27 lub HZA-R w zakresie od M12 do M24.
- tuleja z gwintem wewnętrznym HIS-(R)N w zakresie od M8 do M20 oraz od 3/8 cala do 3/4 cala.

Przedmiotowy element stalowy jest wprowadzany do wywierconego otworu wypełnionego żywicą iniekcyjną i kotwiony poprzez wiązanie chemiczne powstające pomiędzy tym elementem stalowym, żywicą iniekcyjną oraz betonem.

Rysunek i opis produktu zostały przedstawione w Załącznikach A.

2 Wyszczególnienie zamierzonego stosowania wyrobu

Właściwości użytkowe podane w Rozdziale 3 obowiązują wyłącznie wtedy, gdy przedmiotowy łącznik jest stosowany zgodnie ze specyfikacjami i warunkami podanymi w Załączniku B.

Warunki zawarte w niniejszej Europejskiej Ocenie Technicznej oparte są na założeniu, że okres użytkowania łącznika będzie wynosił 50 lat oraz 100 lat. Wskazania dotyczące okresu użytkowania nie mogą być interpretowane jako gwarancja udzielona przez producenta, a jedynie jako przesłanki mające pomóc w wyborze odpowiedniego produktu spełniającego oczekiwania z punktu widzenia uzasadnionego ekonomicznie czasu eksploatacji wykonanych robót.

3 Właściwości użytkowe produktu

3.1 Wytrzymałość mechaniczna i stateczność (Wymaganie podstawowe 1)

Podstawowa charakterystyka	Właściwości
Charakterystyczna nośność dla obciążeń statycznych i quasi-statycznych, Przemieszczenia	Patrz → Załączniki od C1 do C28
Charakterystyczna nośność dla obciążeń sejsmicznych kategorii C1	Patrz → Załączniki od C29 do C35
Charakterystyczna nośność dla obciążeń sejsmicznych kategorii C2, Przemieszczenia	Patrz → Załączniki od C36 do C38

3.2 Bezpieczeństwo pożarowe (Wymaganie podstawowe 2)

Podstawowa charakterystyka	Właściwości
Reakcja na działanie ognia	Łączniki spełniają wymogi dla Klasy A1
Odporność ogniowa	Patrz → Załączniki od C39 do C42

3.3 Higiena, zdrowie i środowisko (Wymaganie podstawowe 3)

W odniesieniu do wymagań dotyczących substancji niebezpiecznych zawartych w niniejszej Europejskiej Ocenie Technicznej, mogą mieć zastosowanie wymagania dla produktów objętych jej zakresem (np. przetransponowane ustawodawstwo europejskie oraz prawo krajowe, przepisy i klauzule administracyjne). Dla spełnienia warunków zawartych w *Dyrektywie dotyczącej wyrobów budowlanych* należy również przestrzegać takich wymagań tam, gdzie mają one zastosowanie.

3.4 Bezpieczeństwo użytkowania (Wymaganie podstawowe 4)

Dla Podstawowego wymagania *Bezpieczeństwo użytkowania* obowiązują te same kryteria, jakie obowiązują dla o Podstawowego wymagania *Wytrzymałość mechaniczna i stateczność*.

3.5 Ochrona przed hałasem (Wymaganie podstawowe 5)

Nie istotne.

3.6 Gospodarka energią oraz retencja (zatrzymanie) ciepła (Wymaganie podstawowe 6)

Nie istotne.

3.7 Zrównoważone korzystanie z zasobów naturalnych (Wymaganie podstawowe 7)

Dla niniejszego produktu nie określono charakterystyki dotyczącej zrównoważonego korzystania z zasobów naturalnych.

3.8 Ogólne aspekty dotyczące przydatności do stosowania

Trwałość i użyteczność produktu są zapewnione jedynie w przypadku, gdy wzięto pod uwagę specyfikacje zamierzonego stosowania zgodną z Załącznikiem B1.

4 Ocena i weryfikacja stałości właściwości użytkowych (AVCP)

Zgodnie z Decyzją 96/582/EC Komisji Europejskiej¹ z późniejszymi poprawkami, zastosowanie ma system oceny i weryfikacji stałości właściwości użytkowych (patrz: → Załącznik V do Rozporządzenia (Unii Europejskiej) Nr 305/2011) wymieniony w poniższej tabeli.

Produkt	Zamierzone stosowanie	Poziom lub klasa	System
Łączniki wklejane do stosowania w betonie	Do mocowania do betonu oraz/lub do podtrzymywania elementów konstrukcji (przyczyniających się do stateczności robót) lub ciężkich elementów	—	1

5 Szczegóły techniczne konieczne do wdrożenia systemu oceny i weryfikacji stałości właściwości użytkowych (AVCP)

Szczegóły techniczne konieczne do wdrożenia Systemu oceny i weryfikacji stałości właściwości użytkowych (AVCP) są zawarte w planie kontroli przechowywanym w Centre Scientifique et Technique du Bâtiment.

W niniejszej Europejskiej Ocenie Technicznej powołano się na następujące normy:

- EN 1992-1-1:2004 + AC:2010 Eurokod 2: Projektowanie konstrukcji z betonu – Część 1-1: Reguły ogólne i reguły dla budynków
- EN 1992-1-2:2004 + AC:2008 Eurokod 2: Projektowanie konstrukcji z betonu - Część 1-2: Reguły ogólne - Projektowanie z uwagi na warunki pożarowe
- EN 1992-4:2018 Eurokod 2: Projektowanie konstrukcji z betonu - Część 4: Projektowanie zamocowań do stosowania w betonie
- EN 1993-1-4:2006 + A1:2015 Eurokod 3 - Projektowanie konstrukcji stalowych - Część 1-4: Reguły ogólne - Reguły uzupełniające dla konstrukcji ze stali nierdzewnych
- EN 1998-1:2004 + A1:2013 Eurokod 8: Projektowanie konstrukcji poddanych oddziaływaniom sejsmicznym - Część 1: Reguły ogólne, oddziaływania sejsmiczne i reguły dla budynków
- EN 10088-1:2014 Stale nierdzewne - Część 1: Wykaz stali nierdzewnych
- EN 206:2013 + A2:2021 Beton: Wymagania, właściwości, produkcja i zgodność

¹ Dziennik urzędowy Wspólnot Europejskich nr L 254 z 08.10.1996r.

Plan kontroli włącznie z informacjami poufnymi nie został zawarty w opublikowanej części niniejsze Europejskiej Oceny Technicznej.

Producent, na podstawie umowy, zaangażuje jednostkę notyfikowaną uprawnioną do wydania certyfikatu zgodności CE (Wspólnoty Europejskiej) w dziedzinie łączników, w oparciu o przedmiotowy plan kontroli.

Jednostka Notyfikowana ma obowiązek wizytowania fabryki przynajmniej dwa razy w roku w celu nadzoru nad producentem.

Oryginalna wersja w języku francuskim została podpisana przez:

Anca CRONOPOL

Kierownik Działu Konstrukcji, Murów, Przegród

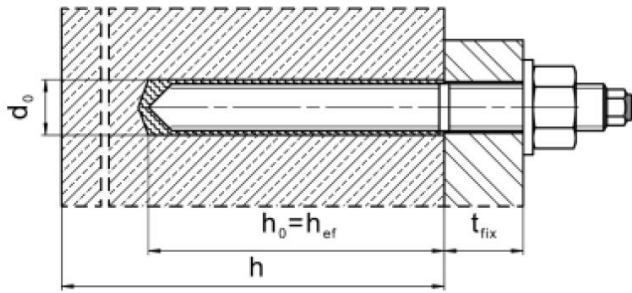
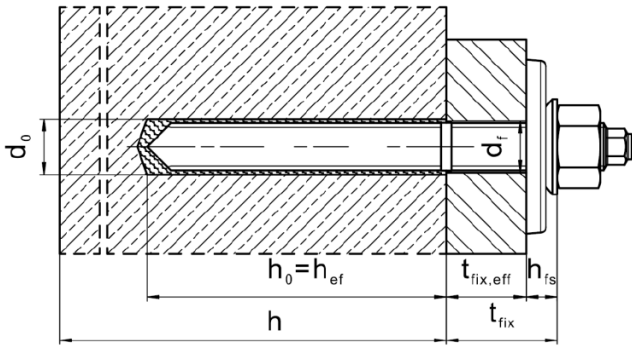
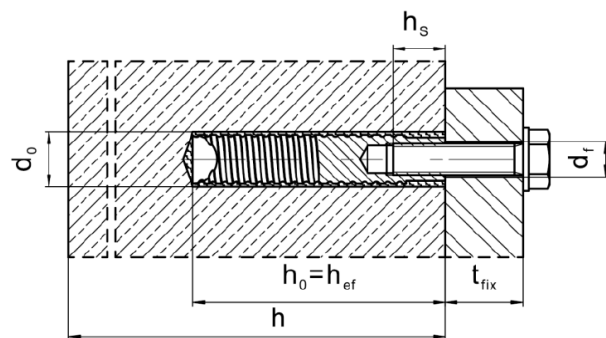
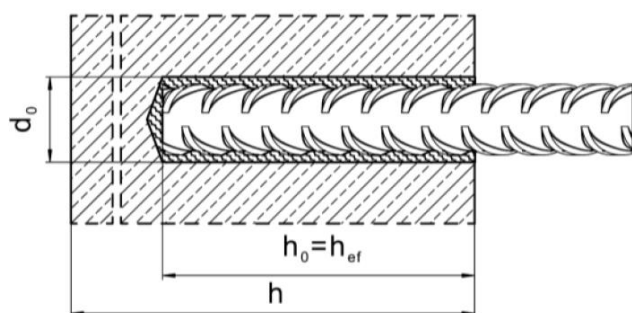
Warunki montażu**Rysunek A1:** Pręt gwintowany, HAS ..., HAS-U-..., HAS-..., HIT-V-..., AM...**Rysunek A2:** Pręt gwintowany, HAS ..., HAS-U-..., HIT-V-..., AM..., z zestawem Hilti do wypełniania ...**Rysunek A3:** Tuleja z gwintem wewnętrznym HIS-(R)N**Rysunek A4:** Pręt zbrojeniowy

System iniecyjny Hilti HIT-RE 500 V4

Opis produktu
Warunki montażu

Załącznik A1

Opis produktu: żywica iniekcyjna oraz elementy stalowe

Żywica iniekcyjna Hilti HIT-RE 500 V4: system żywicy epoksydowej z wypełniaczem
330 ml, 500 ml oraz 1400 ml

Oznaczenie:
HILTI HIT
Data produkcji
Czas produkcji i linia produkcyjna
Termin przydatności miesiąc/rok



Nazwa produktu: "Hilti HIT-RE 500 V4"

Mieszacz statyczny Hilti HIT-RE-M



Elementy stalowe



Oznaczenie

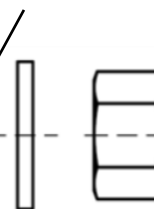

podkładka nakrętka sześciokątna

HAS-U-...: od M8 do M30

Oznaczenie: Liczba oznaczająca klasę stali oraz liczba identyfikująca długość

- 5 = HAS-U 5.8, 5.8 HDG
- 8 = HAS-U 8.8, 8.8 HDG
- 1 = HAS-U A4
- 2 = HAS-U HCR

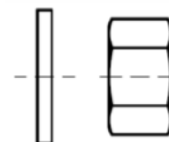
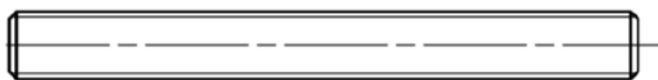

podkładka nakrętka sześciokątna

HAS ...: M8 do M30

HAS Oznaczenie kodem kolorów:

- 5.8 = RAL 5010 (niebieski)
- 8.8 = RAL 1023 (żółty)
- A4 = RAL 3000 (czerwony)

AM ... 8.8: (HDG) od M8 do M30

System iniekcyjny Hilti HIT-RE 500 V4

Opis produktu
Elementy stalowe.

Załącznik A2

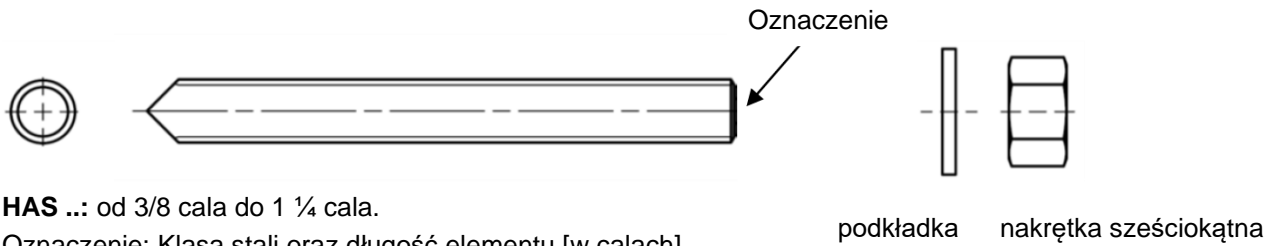

HAS ...: od 3/8 cala do 1 ¼ cala.

Oznaczenie: Klasa stali oraz długość elementu [w calach]

- V = HAS-V-36 (HDG)
- E = HAS-E-55
- B = HAS-B-105 (HDG)
- R1 = HAS-R 304
- R2 = HAS-R 316

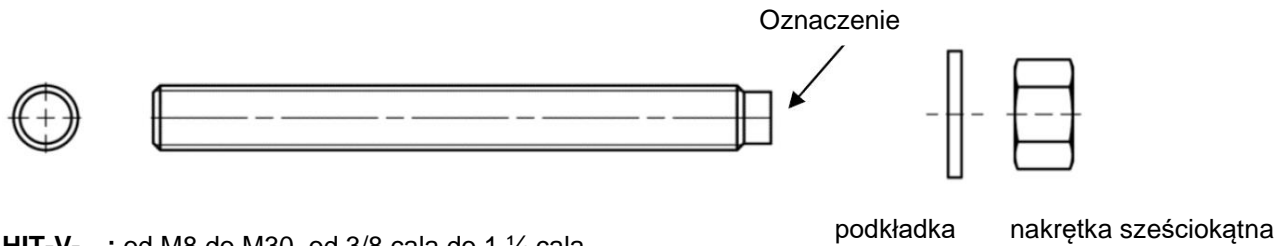

HIT-V-...: od M8 do M30, od 3/8 cala do 1 ¼ cala.

Oznaczenie: np.

- 5.8 - I = HIT-V-5.8 M...x l
- 5.8F - I = HIT-V-5.8F M...x l
- 8.8 - I = HIT-V-8.8 M...x l
- 8.8F - I = HIT-V-8.8F M...x l
- R - I = HIT-V-R M...x l
- HCR - I = HIT-V-HCR M...x l

Pręty gwintowane dostępne w handlu: od M8 do M30, od 3/8 cala do 1 ¼ cala.

- Materiały oraz właściwości mechaniczne zgodne z Tabelą A2.
- Certyfikat z inspekcji 3.1 zgodny z normą EN 10204. Dokument należy przechowywać.
- Oznaczenie głębokości osadzenia.

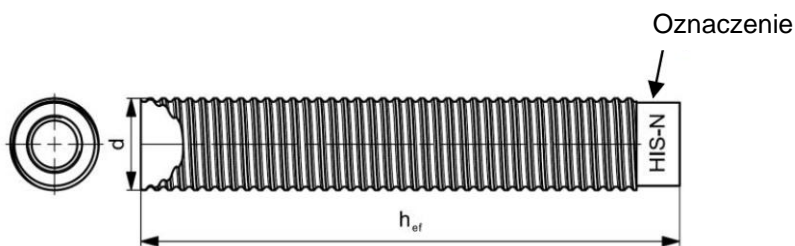

Tuleja z gwintem wewnętrznym HIS-(R)N: od M8 do M20, od 3/8 cala do 3/4 cala.

Oznaczenie:

Znak identyfikacyjny – HILTI oraz wytłoczenie „HIS-N” (dla stali ocynkowanej) lub wytłoczenie „HIS-RN” (dla stali nierdzewnej)

System iniekcyjny Hilti HIT-RE 500 V4

Opis produktu
Elementy stalowe.

Załącznik A3

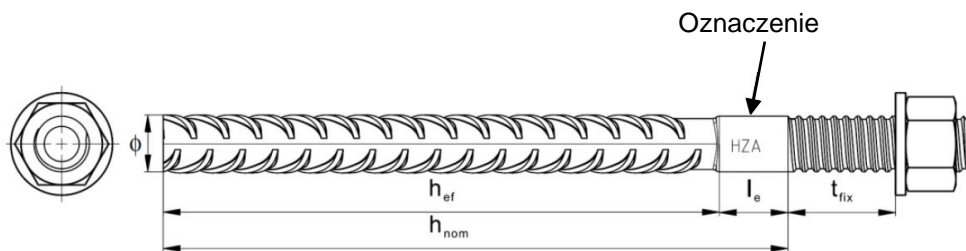

Kotwa naprężeniowa Hilti HZA: od M12 do M27

Kotwa naprężeniowa Hilti HZA-R: od M12 do M24

Oznaczenie:

wytłoczenie „HZA-R” M .. / tfix



Pręt zbrojeniowy: od ϕ 8 do ϕ 32

- Materiały oraz właściwości mechaniczne zgodne z Tabelą A2.
- Wymiary zgodne z podanymi w Załączniku B.
- Minimalna wartość odnośnej powierzchni żebra $f_{R,min}$ zgodna z normą EN 1992-1-1:2004+AC:2010
- Wysokość żebra pręta zbrojeniowego h_{rib} musi zawierać się w zakresie $0,05 \cdot \phi \leq h_{rib} \leq 0,07 \cdot \phi$
(ϕ : średnica nominalna pręta zbrojeniowego; h_{rib} : wysokość żebra pręta zbrojeniowego)

Zestaw Hilti do wypełniania pierścieniowej przestrzeni pomiędzy kotwą a elementem mocowanym

Podkładka uszczelniająca

Podkładka sferyczna



Tabela A1: Geometria Zestawu Hilti do wypełniania

Zestaw Hilti do wypełniania		M8	M10	M12	M16	M20	M24
Średnica podkładki uszczelniającej	d_{vs} [mm]	38	42	44	52	60	70
Grubość podkładki uszczelniającej	h_{vs} [mm]	5			6		
Grubość zestawu Hilti do wypełniania	h_{rs} [mm]	8	9	10	11	13	15

System iniekcyjny Hilti HIT-RE 500 V4

Opis produktu
Elementy stalowe.

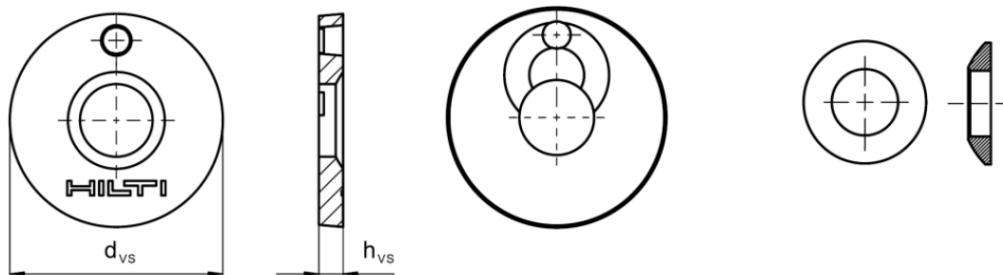
Załącznik A4

Tabela A2: Materiały

Opis elementu	Materiał
Pręty zbrojeniowe	
Pręt zbrojeniowy według normy EN 1992-1-1:2004 oraz AC:2010, Załącznik C	Pręty proste i pręty rozwijane z kręgów klasy B lub C o f_{yk} oraz k zgodnych z NDP lub NCL normy EN 1992-1-1/NA:2013 $f_{uk} = f_{tk} = k \cdot f_{yk}$
Elementy metalowe wykonane ze stali ocynkowej	
HAS 5.8 (HDG) HAS-U-5.8 (HDG) HIT-V-5.8 (F) Pręt gwintowany 5.8	Klasa wytrzymałości stali 5.8, $f_{uk} = 500 \text{ N/mm}^2$, $f_{yk} = 400 \text{ N/mm}^2$ Wydłużenie przy zerwaniu ($l_0 = 5d$) > 8% ciągliwa Powlekany warstwą cynku galwanicznego o grubości $\geq 5 \mu\text{m}$, (F) lub (HDG) ocynkowany ogniowo grubość powłoki $\geq 50 \mu\text{m}$
Pręt gwintowany 6.8	Klasa wytrzymałości stali 6.8, $f_{uk} = 600 \text{ N/mm}^2$, $f_{yk} = 480 \text{ N/mm}^2$ Wydłużenie przy zerwaniu ($l_0 = 5d$) > 8% ciągliwa Powlekany warstwą cynku galwanicznego o grubości $\geq 5 \mu\text{m}$, (F) lub (HDG) ocynkowany ogniowo grubość powłoki $\geq 50 \mu\text{m}$
HAS-U-8.8 (HDG) HAS-U-8.8 (HDG) HIT-V-8.8 (F) AM 8.8 Pręt gwintowany 8.8	Klasa wytrzymałości stali 8.8, $f_{uk} = 800 \text{ N/mm}^2$, $f_{yk} = 640 \text{ N/mm}^2$ Wydłużenie przy zerwaniu ($l_0 = 5d$) > 12% ciągliwa Powlekany warstwą cynku galwanicznego o grubości $\geq 5 \mu\text{m}$, (F) lub (HDG) ocynkowany ogniowo, grubość powłoki $\geq 50 \mu\text{m}$
Kotwa naprężeniowa Hilti HZA	Okrągły pręt stalowy częściowo nagwintowany: powlekany warstwą cynku galwanicznego o grubości $\geq 5 \mu\text{m}$ Pręt zbrojeniowy: pręty klasy B zgodne z NDP lub NCL normy EN 1992-1-1/NA
Tuleja z gwintem wewnętrznym HIS-N	Powlekana warstwą cynku galwanicznego o grubości $\geq 5 \mu\text{m}$
Pręt gwintowany, HIT-V	Norma ASTM A 307, Klasa A, $f_{uk} = 414 \text{ N/mm}^2$, $f_{yk} = 259 \text{ N/mm}^2$ Wydłużenie przy zerwaniu ($l_0 = 5d$) > 8% ciągliwa Stal ocynkowana galwanicznie, grubość $\geq 5 \mu\text{m}$
Pręt gwintowany, HAS-V-36 (HDG)	Norma ASTM F1554, Klasa 36, $f_{uk} = 400 \text{ N/mm}^2$, $f_{yk} = 248 \text{ N/mm}^2$ Wydłużenie przy zerwaniu ($l_0 = 5d$) > 23% ciągliwa Stal ocynkowana galwanicznie, grubość $\geq 5 \mu\text{m}$, (HDG) stal ocynkowana ogniowo $\geq 53 \mu\text{m}$
Pręt gwintowany, HAS-E-55	Norma ASTM F1554, Klasa 55, $f_{uk} = 517 \text{ N/mm}^2$, $f_{yk} = 379 \text{ N/mm}^2$ Wydłużenie przy zerwaniu ($l_0 = 5d$) > 21% ciągliwa Stal ocynkowana galwanicznie, grubość $\geq 5 \mu\text{m}$
Pręt gwintowany, HAS-B-105 (HDG)	Norma ASTM F1554, Klasa 105, $f_{uk} = 862 \text{ N/mm}^2$, $f_{yk} = 724 \text{ N/mm}^2$ Wydłużenie przy zerwaniu ($l_0 = 5d$) > 15% ciągliwa Stal ocynkowana galwanicznie, grubość $\geq 5 \mu\text{m}$, (HDG) stal ocynkowana ogniowo $\geq 53 \mu\text{m}$
Podkładka	Powlekana warstwą cynku galwanicznego o grubości $\geq 5 \mu\text{m}$, ocynkowana ogniowo, grubość powłoki $\geq 50 \mu\text{m}$
Nakrętka sześciokątna	Nominalna klasa wytrzymałości równa lub wyższa od nominalnej klasy wytrzymałości pręta gwintowanego. Powlekana warstwą cynku galwanicznego o grubości $\geq 5 \mu\text{m}$, ocynkowana ogniowo, grubość powłoki $\geq 50 \mu\text{m}$
Zestaw Hilti do wypełniania (F)	Podkładka wypełniająca: Powlekana warstwą cynku galwanicznego o grubości $\geq 5 \mu\text{m}$, (F) ocynkowany ogniowo, grubość powłoki $\geq 50 \mu\text{m}$ Podkładka sferyczna: Powlekana warstwą cynku galwanicznego o grubości $\geq 5 \mu\text{m}$, (F) ocynkowany ogniowo, grubość powłoki $\geq 50 \mu\text{m}$ Nakrętka kontruująca: Powlekana warstwą cynku galwanicznego o grubości $\geq 5 \mu\text{m}$, (F) Powlekany warstwą cynkowo-niklową, grubość powłoki $\geq 6 \mu\text{m}$

System iniekcyjny Hilti HIT-RE 500 V4

Opis produktu
Materiały.

Załącznik A5

Tabela A2: ciąg dalszy

Elementy stalowe wykonane ze stali nierdzewnej	
Klasa odporności na korozję (CRC II) zgodnie z normą EN 1993-1-4	
Pręt gwintowany	Dla \leq M24: klasa wytrzymałości stali 70, $f_{uk} = 700$ N/mm ² , $f_{yk} = 450$ N/mm ² Dla $>$ M24: klasa wytrzymałości stali 50, $f_{uk} = 500$ N/mm ² , $f_{yk} = 210$ N/mm ² Wydłużenie przy zerwaniu ($l_0 = 5d$) $>$ 12% ciągliwa Stal nierdzewna 1.4301, 1.4307, 1.4311, 1.4541, 1.4306, 1.4567 według normy EN 10088-1
Podkładka	Stal nierdzewna 1.4301, 1.4307, 1.4311, 1.4541, 1.4306, 1.4567 według normy EN 10088-1
Nakrętka sześciokątna	Dla \leq M24: klasa wytrzymałości stali 70, $f_{uk} = 700$ N/mm ² , $f_{yk} = 450$ N/mm ² Dla $>$ M24: klasa wytrzymałości stali 50, $f_{uk} = 500$ N/mm ² , $f_{yk} = 210$ N/mm ² Stal nierdzewna 1.4301, 1.4307, 1.4311, 1.4541, 1.4306, 1.4567 według normy EN 10088-1: 2014
Pręt gwintowany, HAS-R 304	Rozmiar od 3/8 cala do 5/8 cala: Norma ASTM F593 CW1, $f_{uk} = 689$ N/mm ² , $f_{yk} = 448$ N/mm ² Wydłużenie przy zerwaniu ($l_0 = 5d$) $>$ 12% ciągliwa Rozmiar od 3/4 cala do 1 cala: Norma ASTM F593 CW2, $f_{uk} = 586$ N/mm ² , $f_{yk} = 310$ N/mm ² Wydłużenie przy zerwaniu ($l_0 = 5d$) $>$ 12% ciągliwa Rozmiar $>$ 1 cala: Norma ASTM A193 gatunek 8(M), klasa 1, $f_{uk} = 515$ N/mm ² , $f_{yk} = 205$ N/mm ² Wydłużenie przy zerwaniu ($l_0 = 5d$) $>$ 12% ciągliwa
Podkładka	Stal nierdzewna ASTM F593 oraz ASTM A193
Nakrętka sześciokątna	Nominalna klasa wytrzymałości stali równa lub wyższa od nominalnej klasy wytrzymałości pręta gwintowanego
Elementy stalowe wykonane ze stali nierdzewnej	
Klasa odporności na korozję (CRC III) zgodnie z normą EN 1993-1-4	
HAS A4 HAS-U A4, HIT-V-R, Pręt gwintowany A4	Dla \leq M24: klasa wytrzymałości stali 70, $f_{uk} = 700$ N/mm ² , $f_{yk} = 450$ N/mm ² Dla $>$ M24: klasa wytrzymałości stali 50, $f_{uk} = 500$ N/mm ² , $f_{yk} = 210$ N/mm ² Wydłużenie przy zerwaniu ($l_0 = 5d$) $>$ 12% ciągliwa Stal nierdzewna 1.4401, 1.4404, 1.4578, 1.4571, 1.4439, 1.4362 według normy EN 10088-1
Kotwa naprężeniowa Hilti HZA-R	Okragły pręt stalowy częściowo nagwintowany: Stal nierdzewna według normy EN 10088-1:2014 Pręt zbrojeniowy: pręty klasy B zgodne z NDP lub NCL wg normy EN 1992-1-1/NA:2013
Tuleja z gwintem wewnętrznym HIS-RN	Stal nierdzewna 1.4401, 1.4571 według normy EN 10088-1
Pręt gwintowany, HAS-R 316	Rozmiar od 3/8 cala do 5/8 cala: Norma ASTM F593 CW1, $f_{uk} = 689$ N/mm ² , $f_{yk} = 448$ N/mm ² Wydłużenie przy zerwaniu ($l_0 = 5d$) $>$ 12% ciągliwa Rozmiar od 3/4 cala do 1 1/4 cala: Norma ASTM F593 CW2, $f_{uk} = 586$ N/mm ² , $f_{yk} = 310$ N/mm ² Wydłużenie przy zerwaniu ($l_0 = 5d$) $>$ 12% ciągliwa
Podkładka	Stal nierdzewna ASTM F593
Nakrętka sześciokątna	Nominalna klasa wytrzymałości stali równa lub wyższa od nominalnej klasy wytrzymałości pręta gwintowanego.
Zestaw Hilti do wypełniania A4	Podkładka wypełniająca: Stal nierdzewna według normy EN 10088-1 Podkładka sferyczna: Stal nierdzewna według normy EN 10088-1 Nakrętka kontrolująca: Stal nierdzewna według normy EN 10088-1

System iniekcyjny Hilti HIT-RE 500 V4

Opis produktu
Materiały.

Załącznik A6

Tabela A2: ciąg dalszy

Elementy stalowe wykonane ze stali o wysokiej odporności na korozję Klasa odporności na korozję (CRC V) zgodnie z normą EN 1993-1-4	
HAS-U HCR HIT-V-HCR Pręt gwintowany	Dla $\leq M20$: $f_{uk} = 800 \text{ N/mm}^2$, $f_{yk} = 640 \text{ N/mm}^2$ Dla $> M20$: $f_{uk} = 700 \text{ N/mm}^2$, $f_{yk} = 400 \text{ N/mm}^2$ Wydłużenie przy zerwaniu ($l_0 = 5d$) $> 12\%$ ciągliwa Stal o wysokiej odporności na korozję 1.4529, 1.4565 według normy EN 10088-1
Podkładka	Stal o wysokiej odporności na korozję 1.4529, 1.4565 według normy EN 10088-1
Nakrętka sześciokątna	Nominalna klasa wytrzymałości stali równa lub wyższa od nominalnej klasy wytrzymałości pręta gwintowanego. Stal o wysokiej odporności na korozję 1.4529, 1.4565 według normy EN 10088-1

System iniekcyjny Hilti HIT-RE 500 V4**Opis produktu**
Materiały.**Załącznik A6**

Szczegóły techniczne zamierzonego stosowania**Łączniki poddawane:**

- Obciążeniom statycznym i quasi-statycznym.
- Obciążeniom o charakterze sejsmicznym kategorii C1.
- Obciążeniom o charakterze sejsmicznym kategorii C2 (HAS (8.8, 8,8 HDG, A4), HAS-U (8.8, 8,8 HDG, A4, HCR), HIT-V (-8.8, -8,8F, -R, -HCR), AM (8.8, 8,8 HDG) oraz standardowe pręty gwintowane (klasa 8.8, A4, HCR)), dla wiercenia udarowego oraz dla wiercenia udarowego przy użyciu wiertel rurowych Hilti TE-CD, TE-YD.
- Ekspozycja na działanie pożaru: pręt gwintowany w rozmiarach od M8 do M30 (HAS (5.8, 5,8 HDG, 8.8, 8.8 HDG, A4-70), (HAS-U (5.8, 5,8 HDG, 8.8, 8.8 HDG, A4-70, HCR), HIT-V (5.8, 5,8F, 8.8, 8.8F, R, HCR), od 3/8 do 1 ¼ cala (HAS-E-55, HAS-B (HDG)) oraz standardowe pręty gwintowane (klasa 8.8, A4, HCR)), dla wiercenia udarowego oraz dla wiercenia udarowego przy użyciu wiertel rurowych Hilti TE-CD, TE-YD.

Materiał podłoża:

- Zagęszczony, zbrojony lub niezbrojony beton o standardowym ciężarze zgodny z normą EN 206
- Klasy wytrzymałości betonu od C20/25 do C50/60 zgodne z normą EN 206
- Beton zarysowany i beton niezarysowany.

Temperatura wewnątrz podłoża:

- **w trakcie montażu**
od - 5 °C do + 40 °C dla znormalizowanej zmienności temperatur po przeprowadzeniu montażu.
- **w trakcie eksploatacji**
Zakres temperatur I: od -40 °C do +40 °C
(maksymalna dopuszczalna temperatura przy oddziaływaniu długotrwałym +24 °C i maksymalna dopuszczalna temperatura przy oddziaływaniu krótkotrwałym +40 °C)
Zakres temperature II: od -40 °C do +55 °C
(maksymalna dopuszczalna temperatura przy oddziaływaniu długotrwałym +43 °C i maksymalna dopuszczalna temperatura przy oddziaływaniu krótkotrwałym +55 °C)
Zakres temperature III: od -40 °C do +75 °C
(maksymalna dopuszczalna temperatura przy oddziaływaniu długotrwałym +55 °C i maksymalna dopuszczalna temperatura przy oddziaływaniu krótkotrwałym +75 °C)

Warunki stosowania (warunki środowiskowe):

- Konstrukcje poddane oddziaływaniu warunków suchych wewnątrz budowli (wszystkie rodzaje materiałów).
- Dla wszelkich pozostałych warunków zgodnych z normą EN 1993-1-4, odpowiadających klasom odporności na korozję podanym w Załączniku A (stal nierdzewna lub stal o wysokiej odporności na korozję).

Projektowanie:

- Łączniki muszą być zaprojektowane pod nadzorem inżyniera doświadczonego w dziedzinie zakotwień i robót betonowych.
- Należy wykonać możliwe do weryfikacji obliczenia oraz opracować rysunki, biorąc pod uwagę obciążenia, które mają być przeniesione. Położenie kotew musi być określone na rysunkach projektowych (np. poprzez podanie położenia łącznika względem zbrojenia lub względem podpór, itd).
- Łączniki muszą być zaprojektowane zgodnie z normą EN 1992-4 oraz z Raportem Technicznym EOTA TR 055. Łączniki poddawane obciążeniom sejsmicznym będą zlokalizowane poza strefami krytycznymi (np. plastycznych przegubów) konstrukcji betonowej. Zamocowania uwzględniające montaż dystansowy lub na warstwie podlewki poddawane obciążeniom sejsmicznym nie są objęte niniejszą Europejską Oceną Techniczną (ETA).
- Dla zastosowań o wymaganej nośności w warunkach pożaru, łączniki muszą być zaprojektowane zgodnie z Raportem Technicznym EOTA TR 082 „Projektowanie łączników klejanych w betonie w warunkach pożaru”

System iniekcyjny Hilti HIT-RE 500 V4**Zamierzone stosowanie**
Specyfikacje techniczne.**Załącznik B1**

Montaż:

- Kategoria użytkowania:
- suchy lub wilgotny beton (montaż w otworach wypełnionych wodą niedopuszczalny): dla wszystkich technik wiercenia otworów
- wywiercone otwory wypełnione wodą: wyłącznie dla wiercenia udarowego, wyłącznie dla betonu niezarysowanego
- Technika wiercenia otworów:
 - wiercenie udarowe,
 - wiercenie udarowe przy użyciu wiertel rurowych Hilti TE-CD, TE-YD,
 - wiercenie diamentowe rdzeniowe, wyłącznie dla betonu niezarysowanego,
 - wiercenie diamentowe rdzeniowe z szorstkowaniem powierzchni otworu przy użyciu narzędzia do szorstkowania Hilti TE-YRT.
- Kierunek montażu D3: montaż pionowo w dół, poziomo i pionowo w górę (np. nad głową) dopuszczalny dla wszystkich elementów stalowych.
- Montaż łączników może być przeprowadzony wyłącznie przez odpowiednio wykwalifikowany (przeszkolony) personel oraz pod nadzorem osoby odpowiedzialnej za zagadnienia techniczne budowy.

System iniekcyjny Hilti HIT-RE 500 V4**Zamierzone stosowanie**
Specyfikacje techniczne.**Załącznik B2**

Tabela B1: Parametry montażowe metrycznych prętów gwintowanych według Załącznika A

Metryczny pręt gwintowany według Załącznika A	M8	M10	M12	M16	M20	M24	M27	M30
Średnica elementu d [mm]	8	10	12	16	20	24	27	30
Nominalna średnica wiertła d_0 [mm]	10	12	14	18	22	28	30	35
Czynna głębokość zakotwienia oraz głębokość wierconego otworu h_{ef} [mm]	od 60 do 160	od 60 do 200	od 70 do 240	od 80 do 320	od 90 do 400	od 96 do 480	od 108 do 540	od 120 do 600
Maksymalna średnica otworu przelotowego w elemencie mocowanym d_f [mm]	9	12	14	18	22	26	30	33
Grubość zestawu do wypełniania Hilti h_{fs} [mm]	8	9	10	11	13	15	-	-
Czynna grubość elementu mocowanego przy montażu z zestawem do wypełniania Hilti $t_{fix,eff}$ [mm]	$t_{fix,eff} = t_{fix} + h_{fs}$							
Minimalna grubość elementu betonowego h_{min} [mm]	$h_{ef} + 30$ ≥ 100 mm			$h_{ef} + 2 \cdot d_0$				
Maksymalny montażowy moment dokręcający $maks. T_{max}$ [Nm]	10	20	40	80	150	200	270	300
Minimalny rozstaw kotew S_{min} [mm]	40	50	60	75	90	115	120	140
Minimalna odległość kotew od krawędzi podłoża C_{min} [mm]	40	45	45	50	55	60	75	80

Tabela B2: Parametry montażowe stalowych prętów gwintowanych według Załącznika A

Stalowy pręt gwintowany według Załącznika A	3/8	1/2	5/8	3/4	7/8	1	1 1/4
Średnica elementu d [mm]	9,5	12,7	15,9	19,1	22,2	25,4	31,8
Nominalna średnica wiertła d_0 [mm]	7/16	9/16	3/4	7/8	1	1 1/8	1 3/8
Czynna powierzchnia przekroju łącznika $A_s^{1)}$ [mm ²]	50	92	146	216	298	391	625
Czynna głębokość zakotwienia oraz głębokość wierconego otworu h_{ef} [mm]	od 60 do 191	od 70 do 254	od 79 do 318	od 89 do 381	od 89 do 445	od 102 do 508	od 127 do 635
Maksymalna średnica otworu przelotowego w elemencie mocowanym d_f [mm]	11,1	14,3	17,5	20,6	23,8	28,6	34,9
Minimalna grubość elementu betonowego h_{min} [mm]	$h_{ef} + 30$ ≥ 100 mm			$h_{ef} + 2 \cdot d_0$			
Maksymalny montażowy moment dokręcający $maks. T_{inst.}$ [Nm]	20	41	81	136	169	203	271
Minimalny rozstaw kotew S_{min} [mm]	45	60	80	90	105	115	140
Minimalna odległość kotew od krawędzi podłoża C_{min} [mm]	45	45	50	55	60	70	80

1) Czynna powierzchnia przekroju do obliczeń nośności charakterystycznej stali.

System iniekcyjny Hilti HIT-RE 500 V4**Zamierzone stosowanie**
Parametry montażowe.**Załącznik B2**

Tabela B3: Parametry montażowe dla tulei z gwintem wewnętrznym HIS-(R)N

HIS-(R)N			M8	M10	M12	M16	M20
Zewnętrzna średnica tulei	d	[mm]	12,5	16,5	20,5	25,4	27,6
Nominalna średnica wiertła	d_0	[mm]	14	18	22	28	32
Czynna głębokość zakotwienia oraz głębokość wierconego otworu	h_{ef}	[mm]	90	110	125	170	205
Maksymalna średnica otworu przelotowego w elemencie mocowanym ³⁾	d_f	[mm]	9	12	14	18	22
Grubość Zestawu Hilti do wypełniania	h_{fs}	[mm]	8	9	10	11	13
Czynna grubość elementu mocowanego przy użyciu Zestawu Hilti do wypełniania	$t_{fix,eff}$	[mm]	$t_{fix,eff} = t_{fix} + h_{fs}$				
Minimalna grubość elementu betonowego	h_{min}	[mm]	120	150	170	230	270
Maksymalny montażowy moment dokręcający	$maks. T_{inst.}$	[Nm]	10	20	40	80	150
Długość włączenia gwintu min.-maks.	h_s	[mm]	od 8 do 20	od 10 do 25	od 12 do 30	od 16 do 40	od 20 do 50
Minimalny rozstaw kotew	s_{min}	[mm]	60	75	90	115	130
Minimalna odległość kotew od krawędzi podłoża	c_{min}	[mm]	40	45	55	65	90

Tabela B4: Parametry montażowe dla tulei z gwintem wewnętrznym HIS-(R)N

HIS-(R)N, rozmiar		[cal]	3/8	1/2	5/8	3/4
Zewnętrzna średnica tulei	d	[mm]	16,5	20,5	25,4	27,6
Nominalna średnica wiertła	d_0	[cal]	11/16	7/8	1 1/8	1
Czynna głębokość osadzenia oraz głębokość wierconego otworu	h_{ef}	[mm]	110	125	170	205
Maksymalna średnica otworu przelotowego w elemencie mocowanym	d_f	[mm]	11,1	14,3	17,5	20,6
Minimalna grubość elementu betonowego	h_{min}	[mm]	150	170	230	270
Maksymalny montażowy moment dokręcający	$maks. T_{inst.}$	[Nm]	20	41	81	136
Długość włączenia gwintu min.-maks.	h_s	[mm]	od 10 do 25	od 12 do 30	od 16 do 40	od 20 do 50
Minimalny rozstaw kotew	s_{min}	[mm]	70	90	115	130
Minimalna odległość kotew od krawędzi podłoża	c_{min}	[mm]	45	55	65	90

System iniekcyjny Hilti HIT-RE 500 V4

Zamierzone stosowanie
Parametry montażowe.

Załącznik B3

Tabela B5: Parametry montażowe dla kotew naprężeniowych Hilti HZA / HZA-R

HZA			M12	M16	M20	M24	M27	
HZA-R			M12	M16	M20	M24	-	
Średnica pręta zbrojeniowego	ϕ	[mm]	12	16	20	25	28	
Nominalna głębokość osadzenia oraz głębokość wierconego otworu HZA	h_0	[mm]	od 90 do 240	od 100 do 320	od 110 do 400	od 120 do 500	od 140 do 560	
Nominalna głębokość osadzenia oraz głębokość wierconego otworu HZA-R	h_0	[mm]	od 170 do 240	od 180 do 320	od 190 do 400	od 200 do 500	-	
Czynna głębokość zakotwienia HZA ($h_{ef} = h_{nom} - l_e$)	h_{ef}	[mm]	$h_{nom} - 20$					
Czynna głębokość zakotwienia HZA-R ($h_{ef} = h_{nom} - l_e$)	h_{ef}	[mm]	$h_{nom} - 100$					
Długość gładkiej części trzpienia kotwy HZA	l_e	[mm]	20					
Długość gładkiej części trzpienia kotwy HZA-R	l_e	[mm]	100					
Nominalna średnica wiertła	d_0	[mm]	16	20	25	32	35	
Maksymalna średnica otworu w elemencie mocowanym	d_f	[mm]	14	18	22	26	30	
Grubość Zestawu Hilti do wypełniania	h_{fs}	[mm]	10	11	13	15	-	
Czynna grubość elementu mocowanego przy użyciu Zestawu Hilti do wypełniania	$t_{fix,eff}$	[mm]	$t_{fix,eff} = t_{fix} - h_{fs}$					-
Maksymalny moment dokręcający	maks. $T_{inst.}$	[Nm]	40	80	150	200	270	
Minimalna grubość elementu betonowego	h_{min}	[mm]	$h_{nom} + 2 \cdot d_0$					
Minimalny rozstaw kotew	s_{min}	[mm]	65	80	100	130	140	
Minimalna odległość kotew od krawędzi podłoża	c_{min}	[mm]	45	50	55	60	75	

Tabela B6: Parametry montażowe dla prętów zbrojeniowych

Pręt zbrojeniowy		$\phi 8$	$\phi 10$	$\phi 12$	$\phi 14$	$\phi 16$	$\phi 18$	$\phi 20$	$\phi 24$	$\phi 25$	$\phi 28$	$\phi 30$	$\phi 32$	
Średnica	ϕ	[mm]	8	10	12	14	16	18	20	24	25	28	30	32
Czynna głębokość osadzenia oraz głębokość wierconego otworu	h_{ef}	[mm]	od 60 do 160	od 60 do 200	od 70 do 240	od 75 do 280	od 80 do 320	od 85 do 360	od 90 do 400	od 100 do 480	od 100 do 500	od 112 do 560	od 120 do 600	od 128 do 640
Nominalna średnica wiertła	d_0	[mm]	10 ¹⁾ 12 ¹⁾	12 ¹⁾ 14 ¹⁾	14 ¹⁾ 16 ¹⁾	18	20	22	25	30 ¹⁾ 32 ¹⁾	30 ¹⁾ 32 ¹⁾	35	37	40
Minimalna grubość elementu betonowego	h_{min}	[mm]	$h_{ef} + 30$ ≥ 100 mm			$h_{ef} + 2 \cdot d_0$								
Minimalny rozstaw kotew	s_{min}	[mm]	40	50	60	70	80	90	100	125	125	140	150	160
Minimalna odległość kotew od krawędzi podłoża	c_{min}	[mm]	40	45	45	50	50	60	65	70	70	75	80	80

¹⁾ Dopuszczalne jest zastosowanie każdej z dwóch podanych wartości.

System iniekcyjny Hilti HIT-RE 500 V4

Zamierzone stosowanie
Parametry montażowe.

Załącznik B4

Tabela B7: Czas roboczy i czas utwardzania żywicy ^{1) 2)}

Temperatura materiału podłoża T	Maksymalny czas roboczy t _{work}	Minimalny czas utwardzania t _{cure} ¹⁾
od -5 °C do -1 °C	2 godziny	168 godzin
od 0 °C do 4 °C	2 godziny	48 godzin
od 5 °C do 9 °C	2 godziny	24 godziny
od 10 °C do 14 °C	1,5 godziny	16 godzin
od 15 °C do 19 °C	1 godzina	12 godzin
od 20 °C do 24 °C	30 minut	7 godzin
od 25 °C do 29 °C	20 minut	6 godzin
od 30 °C do 34 °C	15 minut	5 godzin
od 35 °C do 39 °C	12 minut	4,5 godziny
od 40 °C	10 minut	4 godziny

¹⁾ Dane dotyczące czasu utwardzania obowiązują wyłącznie dla suchego materiału podłoża. W przypadku podłoża wilgotnego czasy utwardzania muszą być podwojone.

²⁾ Minimalna temperatura ładunku foliowego wynosi + 5° C.

System iniekcyjny Hilti HIT-RE 500 V4**Zamierzone stosowanie.**

Czas roboczy oraz czas utwardzania żywicy

Załącznik B5

Tabela B8: Parametry narzędzi do czyszczenia otworów oraz narzędzi do osadzania

Elementy				Wiercenie i czyszczenie otworu				Montaż	
Metryczny pręt gwintowany (Załącznik A)	HIS-(R)N	Pręt zbrojeniowy	HZA(-R)	Wiercenie udarowe		Wiercenie diamentowe rdzeniowe		Szczotka stalowa	Końcówka iniekcyjna
				Wiertło rurowe TE-CD, TE-YD ¹⁾		Narzędzie do szorstkowania TE-YRT			
Rozmiar	Rozmiar	Rozmiar	Rozmiar	d ₀ [mm]	d ₀ [mm]	d ₀ [mm]	d ₀ [mm]	HIT-RB	HIT-SZ
M8	-	φ 8	-	10	10	10	-	10	-
M10	-	φ 8, φ 10	-	12	12	12	-	12	12
M12	M8	φ 10, φ 12	-	14	14	14	-	14	14
-	-	φ 12	M12	16	16	16	-	16	16
M16	M10	φ 14	-	18	18	18	18	18	18
-	-	φ 16	M16	20	20	20	20	20	20
M20	M12	φ 18	-	22	22	22	22	22	22
-	-	φ 20	M20	25	25	25	25	25	25
M24	M16	-	-	28	28	28	28	28	28
M27	-	φ 24, φ 25	-	30	-	30	30	30	30
-	M20	φ 24, φ 25	M24	32	32	32	32	32	32
M30	-	φ 28	M27	35	35	35	35	35	35
-	-	φ 30	-	37	-	37	-	37	37
-	-	φ 32	-	40	-	-	-	40	40
-	-			-	-	42	-	42	42

¹⁾ Z odkurzaczem Hilti VC 10/20/40 (z uruchomionym automatycznym czyszczeniem filtra, tryb eko wyłączony) lub z innym odkurzaczem zapewniającym równoważną skuteczność czyszczenia w połączeniu z określonym wiertłem rurowym Hilti TE-CD lub TE-YD.









System iniekcyjny Hilti HIT-RE 500 V4

Zamierzone stosowanie.

Przeгляд opcji montażowych / Parametry narzędzi do czyszczenia i osadzania

Załącznik B6

Tabela B9: Parametry narzędzi do czyszczenia otworów oraz narzędzi do osadzania

Elementy		Wiercenie i czyszczenie otworu				Montaż	
Celowe pręty gwintowane (Załącznik A)	HZA(-R)N	Wiercenie udarowe		Wiercenie diamentowe rdzeniowe		Szczotka stalowa	Końcówka iniekcyjna
		Wiertło rurowe TE-CD, TE-YD ¹⁾		Narzędzie do szorstkowania TE-YRT			
							
Rozmiar [cal]	Rozmiar [cal]	d ₀ [cal]	d ₀ [cal]	d ₀ [cal]	d ₀ [cal]	HIT-RB	HIT-SZ
3/8	-	7/16	-	7/16	-	7/16	7/16
1/2	-	9/16	9/16	9/16	-	9/16	9/16
-	3/8	11/16	-	11/16	-	11/16	11/16
5/8	-	3/4	3/4	3/4	3/4	3/4	3/4
3/4	1/2	7/8	7/8	7/8	7/8	7/8	7/8
7/8	-	1	1	1	1	1	1
1	5/8	1 1/8	1 1/8	1 1/8	1 1/8	1 1/8	1 1/8
-	3/4	1 1/4	-	1 1/4	-	1 1/4	1 1/4
1 1/4	-	1 3/8	-	1 3/8	1 3/8	1 3/8	1 3/8

¹⁾ Z odkurzaczem Hilti VC 10/20/40 (z uruchomionym automatycznym czyszczeniem filtra, tryb eko wyłączony) lub z innym odkurzaczem zapewniającym równoważną skuteczność czyszczenia w połączeniu z określonym wiertłem rurowym Hilti TE-CD lub TE-YD.

System iniekcyjny Hilti HIT-RE 500 V4

Zamierzone stosowanie.

Przeгляд opcji montażowych / Parametry narzędzi do czyszczenia i osadzania

Załącznik B7

Tabela B10: Metody czyszczenia otworów

Czyszczenie przy użyciu sprężonego powietrza (CAC):
Dysza do sprężonego powietrza z otworem wylotowym o średnicy co najmniej 3,5 mm (1/7 cala).



Czyszczenie automatyczne (AC):
Czyszczenie odbywa się w trakcie wiercenia otworu przy użyciu systemu do wiercenia Hilti TE-CD oraz TE-YD wyposażonego w odkurzacz.

**Tabela B11: Parametry do stosowania narzędzia do szorstkowania Hilti TE-YRT**





Wiercenie diamentowe rdzeniowe			Narzędzie do szorstkowania TE-YRT		Wskaźnik zużycia RTG...	
						
d ₀					rozmiar	
nominalna [mm]	nominalna [cal]	pomierzona [mm]	d ₀ [mm]	d ₀ [cal]		
18	¾	od 17,9 do 18,2	18	¾	18	¾
20	7/8	od 19,9 do 20,2	20	7/8	20	7/8
22	1	od 21,9 do 22,2	22	1	22	1
25	1 1/8	od 24,9 do 25,2	25	1 1/8	25	1 1/8
28	1 3/8	od 27,9 do 28,2	28	1 3/8	28	1 3/8
30	-	od 29,9 do 30,2	30	-	30	-
32	-	od 31,9 do 32,2	32	-	32	-
35	-	od 34,9 do 35,2	35	-	35	-

Tabela B12: Parametry do stosowania narzędzia do szorstkowania Hilti TE-YRT

h _{ef} [mm]	Czas szorstkowania t _{roughen} (t _{roughen} [sekundy] = h _{ef} [mm] / 10)
od 0 do 100	10
od 101 do 200	20
od 201 do 300	30
od 301 do 400	40
od 401 do 500	50
od 501 do 600	60

Tabela 13: Narzędzie Hilti TE-YRT do szorstkowania oraz wskaźnik jego zużycia RTG

TE-YRT	
RTG	

System iniecyjny Hilti HIT-RE 500 V4**Zamierzone stosowanie.**

Metody czyszczenia otworów / Parametry do stosowania narzędzia do szorstkowania Hilti TE-YRT

Załącznik B8

Instrukcja montażu

Wiercenie otworu

a) Wiercenie udarowe: Dla betonu suchego i wilgotnego oraz dla montażu w wywierconych otworach wypełnionych wodą (z wyłączeniem wody morskiej).

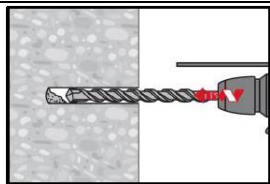

Należy wywiercić otwór o wymaganej głębokości zakotwienia przy użyciu wiertarki udarowej ustawionej w pozycji obrotu z udarem, stosując odpowiednio dobrane wiertło z końcówką z węglików spiekanych.

b) Wiercenie udarowe przy użyciu wiertła rurowego Hilti TE-CD, TE-YD:

Wyłącznie dla betonu suchego i wilgotnego.

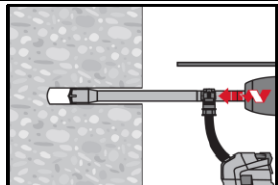

Należy wywiercić otwór o wymaganej głębokości zakotwienia przy użyciu odpowiednio dobranego pod względem rozmiaru wiertła rurowego Hilti TE-CD lub TE-YD przyłączonego do odkurzacza Hilti VC 10/20/40 (z uruchomionym automatycznym czyszczeniem filtra, tryb eko wyłączony) lub z innym odkurzaczem zapewniającym równoważną skuteczność czyszczenia w połączeniu z określonym wiertłem rurowym Hilti TE-CD lub TE-YD. Ten system wiercenia usuwa zwierciny i czyszczy otwór w trakcie wiercenia, pod warunkiem jego zastosowania zgodnie z instrukcją użytkowania. Po zakończeniu wiercenia należy kontynuować czynności według opisanego w dalszej części instrukcji użytkowania kroku "przygotowanie iniekcji żywicy".

c) Wiercenie diamentowe rdzeniowe: Wyłącznie dla betonu suchego i wilgotnego.

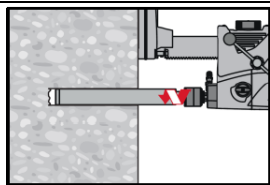

Wiercenie techniką diamentową rdzeniową jest dopuszczalne jedynie w przypadku zastosowania odpowiedniej wiertnicy oraz dopasowanych do niej wiertel rdzeniowych.

d) Wiercenie diamentowe rdzeniowe z szorstkowaniem przy użyciu narzędzia do szorstkowania Hilti TE-YRT: Wyłącznie dla betonu suchego i wilgotnego.

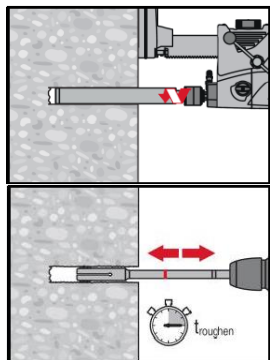

Wiercenie techniką diamentową rdzeniową jest dopuszczalne jedynie w przypadku zastosowania odpowiedniej wiertnicy oraz dopasowanych do niej wiertel rdzeniowych.

W przypadku zastosowania w połączeniu z narzędziem do szorstkowania Hilti TE-YRT należy zastosować parametry podane w Tabeli B8 oraz w Tabeli B9.

Przed rozpoczęciem szorstkowania woda musi być usunięta z wywierconego otworu. Należy zastosować wskaźnik zużycia RTG w celu sprawdzenia, czy narzędzie do szorstkowania nadaje się do użytku.

Następnie należy szorstkować powierzchnię wywierconego otworu na całej długości, biorąc pod uwagę wymaganą głębokość h_{ef} .

System iniekcyjny Hilti HIT-RE 500 V4

Zamierzone stosowanie
Instrukcja montażu

Załącznik B9

Czyszczenie wywierconego otworu: Tuż przed wprowadzeniem elementu stalowego otwór musi zostać oczyszczony z pyłu i ze zwiercin. Niewłaściwe czyszczenie otworu = pogorszenie nośności połączenia.

Czyszczenie za pomocą sprężonego powietrza (CAC):

Dla wszystkich średnic wierconych otworów d_0 oraz dla wszystkich głębokości otworów h_0 .

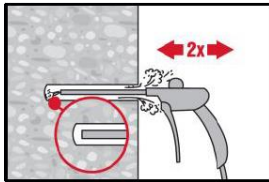

Należy przedmuchać dwukrotnie otwór począwszy od jego końca (jeśli to konieczne, stosując przedłużkę dyszy) na całej długości przy użyciu niezaolejonego sprężonego powietrza (ciśnienie min. 6 bar przy wydajności 6 m³/h), aż do momentu, gdy wylatujący strumień powietrza nie zawiera widocznego kurzu.

Dla wywierconych otworów o średnicach ≥ 32 mm sprężarka musi mieć wydajność strumienia powietrza przynajmniej 140 m³/h.

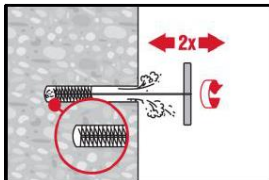

Następnie należy dwukrotnie wyszczotkować otwór przy użyciu stalowej szczotki Hilti HIT-RB o określonym rozmiarze (patrz → Tabela B8 i Tabela B9) poprzez jej wprowadzenie ruchem okrężnym do dna otworu (jeśli to konieczne, stosując przedłużkę) i wyciągnięcie.

Wprowadzana do otworu szczotka napotyka na naturalny opór (\varnothing szczotki $\geq \varnothing$ wierconego otworu) - jeśli się tak nie dzieje, szczotka jest zbyt mała i należy ją zastąpić szczotką o prawidłowej średnicy.

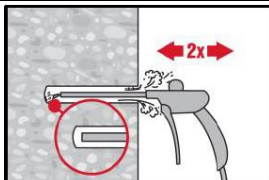

Następnie należy ponownie dwukrotnie wydmuchać otwór przy użyciu sprężonego powietrza aż do momentu, gdy wylatujący strumień powietrza nie zawiera widocznego kurzu.

System iniekcyjny Hilti HIT-RE 500 V4

Zamierzone stosowanie
Instrukcja montażu

Załącznik B10

Czyszczenie i usuwanie wody z otworów wypełnionych wodą wywierconych techniką udarową, techniką udarową przy użyciu wiertel rurowych Hilti oraz otworów wierconych techniką diamentową rdzeniową

Dla wszystkich średnic wierconych otworów d_0 oraz dla wszystkich głębokości otworów h_0 .

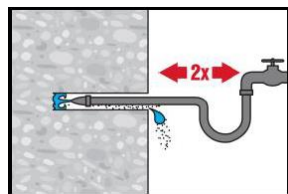

Należy dwukrotnie wypłukać wywiercony otwór poprzez wprowadzenie do niego, aż do dna, węża z wodą (ciśnienie z instalacji wodociągowej) i płukanie aż do momentu, kiedy woda wypływająca z otworu będzie czysta.

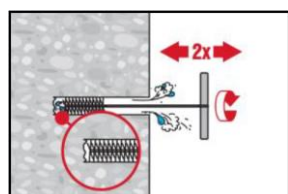

Następnie należy dwukrotnie wyszczotkować otwór z użyciem szczotki o określonym rozmiarze (patrz → Tabela B8 i Tabela B9) poprzez wprowadzenie ruchem okrężnym stalowej szczotki Hilti HIT-RB do dna otworu (jeśli to konieczne, wyposażonej w przedłużkę) i wyciągnięcie jej.

Wsuvanie szczotki do otworu musi wywoływać naturalny opór (\varnothing szczotki $\geq \varnothing$ wierconego otworu) - jeśli tak się nie dzieje, szczotka jest zbyt mała i konieczne jest zastąpienie jej szczotką o właściwej średnicy.

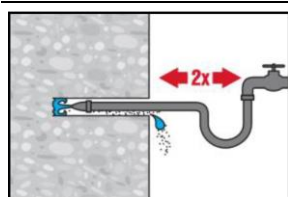

Należy dwukrotnie wypłukać wywiercony otwór poprzez wprowadzenie do niego, aż do dna, węża z wodą (ciśnienie z instalacji wodociągowej) i płukanie aż do momentu, kiedy woda wypływająca z otworu będzie czysta.

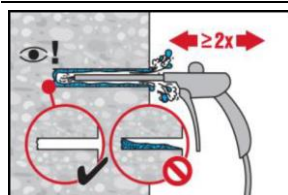

Następnie należy wydmuchać dwukrotnie otwór począwszy od jego końca (jeśli to konieczne, stosując przedłużkę dyszy) na całej długości przy użyciu niezaolejonego sprężonego powietrza (ciśnienie min. 6 bar przy wydajności 6 m³/h), aż do momentu, gdy wylatujący strumień powietrza nie zawiera widocznego kurzu.

Dla wywierconych otworów o średnicy ≥ 32 mm sprężarka musi mieć wydajność strumienia powietrza przynajmniej 140 m³/h.

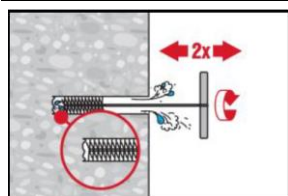

Następnie należy dwukrotnie wyszczotkować otwór z użyciem szczotki o określonym rozmiarze (\varnothing szczotki $\geq \varnothing$ wierconego otworu, patrz → Tabela B8 i Tabela B9) poprzez wprowadzenie ruchem okrężnym stalowej szczotki Hilti HIT-RB do dna otworu (jeśli to konieczne, wyposażonej w przedłużkę) i wyciągnięcie jej.

Wsuvanie szczotki do otworu musi wywoływać naturalny opór - jeśli tak się nie dzieje, szczotka jest zbyt mała i konieczne jest zastąpienie jej szczotką o właściwej średnicy.

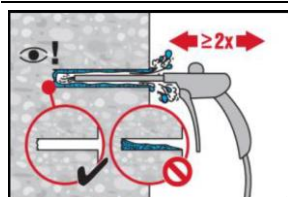

Następnie należy ponownie wydmuchać dwukrotnie otwór przy pomocy sprężonego powietrza, aż do momentu, gdy wylatujący strumień powietrza nie zawiera widocznego kurzu i wody.

System iniekcyjny Hilti HIT-RE 500 V4

Zamierzone stosowanie
Instrukcja montażu

Załącznik B11

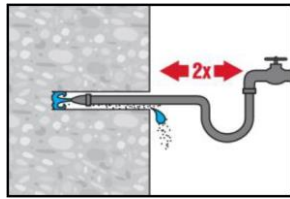
Czyszczenie otworów wywierconych techniką diamentową (rdzeniową) z szorstkowaniem przy użyciu narzędzia do szorstkowania Hilti TE-YRT:Dla wszystkich średnic wywierconych otworów d_0 oraz dla wszystkich głębokości otworów h_0 .

Należy dwukrotnie wypłukać wywiercony otwór poprzez wprowadzenie do niego, aż do dna, węża z wodą (ciśnienie z instalacji wodociągowej) i płukanie aż do momentu, kiedy woda wypływająca z otworu będzie czysta.

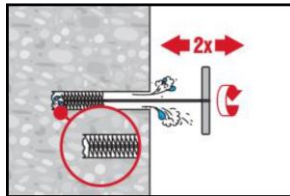

Następnie należy dwukrotnie wyszczotkować otwór z użyciem szczotki o określonym rozmiarze (patrz → Tabela B8 i Tabela B9) poprzez wprowadzenie ruchem okrężnym stalowej szczotki Hilti HIT-RB do dna otworu (jeśli to konieczne, wyposażonej w przedłużkę) i wyciągnięcie jej. Wsuwanie szczotki do otworu musi wywoływać naturalny opór (\varnothing szczotki $\geq \varnothing$ wierconego otworu) - jeśli tak się nie dzieje, szczotka jest zbyt mała i konieczne jest zastąpienie jej szczotką o właściwej średnicy.

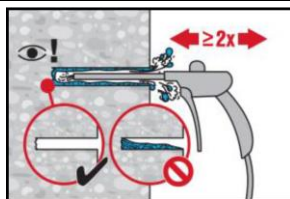

Następnie należy wydmuchać dwukrotnie otwór począwszy od jego końca (jeśli to konieczne, stosując przedłużkę dyszy) na całej długości przy użyciu niezaoilowanego sprężonego powietrza (ciśnienie min. 6 bar przy wydajności 6 m³/h), aż do momentu, gdy wylatujący strumień powietrza nie zawiera widocznego kurzu i wody.

Dla wywierconych otworów o średnicy ≥ 32 mm sprężarka musi mieć wydajność strumienia powietrza przynajmniej 140 m³/h.

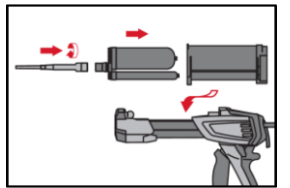
Przygotowanie iniekcji żywicy

Należy dokładnie zamocować mieszacz statyczny Hilti HIT-RE-M do końcówki ładunku foliowego. Nie należy wprowadzać jakichkolwiek zmian w mieszaczu.

Należy zapoznać się z Instrukcją obsługi dozownika.

Należy sprawdzić kasetę ładunku pod kątem prawidłowości funkcjonowania.

Należy wprowadzić ładunek foliowy do kasety oraz kasetę do komory dozownika.

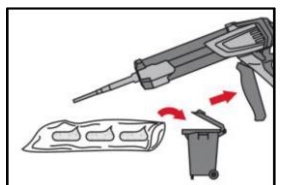

Ładunek foliowy otwiera się automatycznie po rozpoczęciu dozowania. W zależności od objętości ładunku foliowego należy odrzucić określoną porcję żywicy.

Objętości, które należy odrzucić:

3 naciśnięcia spustu	dla ładunku foliowego o pojemności 330 ml,
4 naciśnięcia spustu	dla ładunku foliowego o pojemności 500 ml,
65 ml	dla ładunku foliowego o pojemności 1400 ml.

Minimalna temperatura ładunku foliowego musi wynosić +5 °C.

System iniekcyjny Hilti HIT-RE 500 V4

Zamierzone stosowanie
Instrukcja montażu

Załącznik B12

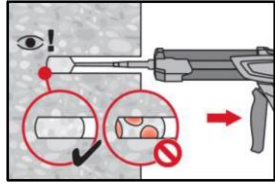
Dozowanie żywicy do otworów bez tworzenia pęcherzyków powietrza.

Należy dozować żywicę począwszy od końca otworu w kierunku powierzchni betonu, powoli wycofując mieszacz statyczny po każdym naciśnięciu spustu dozownika. Należy wypełnić otwór w około 2/3 objętości celem zapewnienia całkowitego wypełnienia żywicą pierścieniowej przestrzeni między elementem stalowym oraz betonem na całej długości zakotwienia.

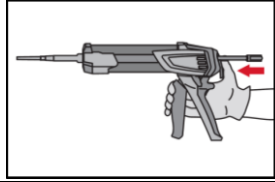

Po zakończeniu dozowania należy odprężyć dozownik poprzez naciśnięcie dźwigni odprężającej. Pozwoli to zapobiec dalszemu wypływowi żywicy z mieszacza statycznego.

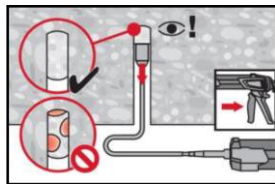

Zastosowania 'nad głową' oraz/lub montaż przy głębokości zakotwienia $h_{ef} > 250$ mm.

Dla zastosowań nad głową dozowanie żywicy jest możliwe wyłącznie przy użyciu przedłużek oraz końcówek iniekcyjnych. Należy połączyć mieszacz statyczny HIT-RE-M, przedłużkę(ki) oraz odpowiednio dobraną pod względem rozmiaru końcówkę iniekcyjną (patrz → Tabela B8 i Tabela B9). Należy wprowadzić końcówkę iniekcyjną do końca otworu i rozpocząć dozowanie. W trakcie dozowania żywicy końcówka iniekcyjna będzie w naturalny sposób wypychana w kierunku początku otworu przez ciśnienie dozowanej żywicy.

Osadzanie elementu

Tuż przed osadzeniem kotwy z wywierconego otworu należy usunąć pył i gruz.

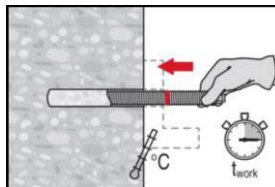

Przed zastosowaniem należy upewnić się, że element jest suchy i wolny od oleju lub innych zanieczyszczeń.

Należy oznaczyć oraz osadzić element z uwzględnieniem wymaganej głębokości zakotwienia przed upływem czasu roboczego t_{work} . Czas roboczy t_{work} został podany w Tabeli B7.

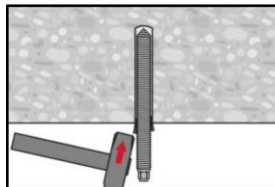

Dla zastosowań 'nad głową' należy używać końcówek iniekcyjnych oraz zamocować osadzone elementy np. przy użyciu klinów.

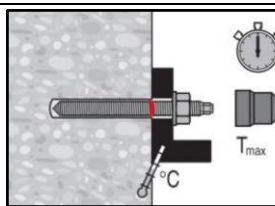

Łącznik może być obciążony po upłynięciu wymaganego czasu wiązania t_{cure} (patrz → Tabela B7).

Zastosowany montażowy moment dokręcający nie może przekroczyć wartości maksymalnej $T_{inst.}$ podanej w Tabelach od Tabeli B1 do Tabeli B5.

System iniekcyjny Hilti HIT-RE 500 V4

Zamierzone stosowanie
Instrukcja montażu

Załącznik B13

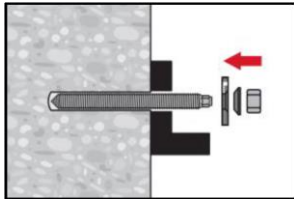
Montaż przy użyciu Zestawu wypełniającego (Hilti Filling Set)

Należy zastosować zestaw Hilti do wypełniania ze standardową nakrętką. Należy sprawdzić prawidłowość położenia podkładki wypełniającej oraz podkładki sferycznej.

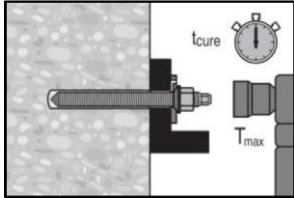

Nie należy przekraczać wartości stosowanego maksymalnego montażowego momentu dokręcającego T_{inst} podanych w Tabelach od Tabeli B1 do Tabeli B5.

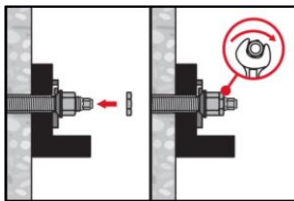

Opcjonalnie: Montaż nakrętki kontrolującej. Należy dokręcić o $\frac{1}{4}$ do $\frac{1}{2}$ obrotu. (Nie stosować dla rozmiaru M24.)

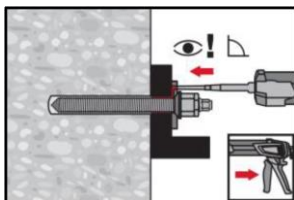

Następnie należy wypełnić pierścieniową przestrzeń pomiędzy prętem kotwy oraz elementem mocowanym przy użyciu 1-3 porcji żywicy iniekcyjnej Hilti HIT-HY ... lub HIT-RE

Dalej należy postępować zgodnie z instrukcją montażu dołączonej do żywicy iniekcyjnej Hilti.

Obciążenie kotwy jest możliwe po upływie wymaganego czasu utwardzania t_{cure} (patrz → Tabela B7).

System iniekcyjny Hilti HIT-RE 500 V4

Zamierzone stosowanie
Instrukcja montażu

Załącznik B14

Tabela C1: Podstawowe charakterystyki dla metrycznych prętów gwintowanych według Załącznika A pod wpływem obciążeń rozciągających w betonie

Metryczny pręt gwintowany według Załącznika A			M8	M10	M12	M16	M20	M24	M27	M30	
Dla okresu użytkowania 50 oraz 100 lat											
Zniszczenie stali											
Nośność charakterystyczna	$N_{Rk,s}$	[kN]	$A_s \cdot f_{uk}$								
Współczynnik częściowy klasa 5.8, 6.8, 8.8 (Tabela A2)	$\gamma_{Ms,N^{(1)}}$	[-]	1,5								
Współczynnik częściowy HAS A4, HAS-U A4, HIT-V-R, pręt gwintowany: CRC II oraz III (Tabela A2)	$\gamma_{Ms,N^{(1)}}$	[-]	1,87						2,86		
Współczynnik częściowy HAS-U HCR, HIT-V-HCR, pręt gwintowany: CRC V (Tabela A2)	$\gamma_{Ms,N^{(1)}}$	[-]	1,5				2,1				
Montażowy współczynnik bezpieczeństwa											
Wiercenie udarowe	γ_{inst}	[-]	1,0								
Wiercenie udarowe przy użyciu wiertel rurowych TE-CD lub TE-YD	γ_{inst}	[-]	1,0								
Wiercenie diamentowe rdzeniowe	γ_{inst}	[-]	1,2			1,4					
Wiercenie diamentowe rdzeniowe z narzędziem do szorstkowania Hilti TE-YRT	γ_{inst}	[-]	2)			1,0					
Wiercenie udarowe w otworach wypełnionych wodą	γ_{inst}	[-]	1,4								
Zniszczenie przez wyłamanie stożka betonu											
Współczynnik dla betonu zarysowanego	$k_{Cr,N}$	[-]	7,7								
Współczynnik dla betonu niezarysowanego	$k_{ucr,N}$	[-]	11,0								
Odległość od krawędzi podłoża	$c_{Cr,N}$	[mm]	$1,5 \cdot h_{ef}$								
Rozstaw elementów stalowych	$s_{Cr,N}$	[mm]	$3,0 \cdot h_{ef}$								
Zniszczenie przez rozłupanie podłoża betonowego											
Odległość od krawędzi podłoża $c_{Cr,sp}$ [mm] dla	$h / h_{ef} \geq 2,0$		$1,0 \cdot h_{ef}$								
	$2,0 > h / h_{ef} > 1,3$		$4,6 \cdot h_{ef} - 1,8 \cdot h$								
	$h / h_{ef} \leq 1,3$		$2,26 \cdot h_{ef}$								
Rozstaw elementów stalowych	$s_{Cr,sp}$	[mm]	$2 \cdot c_{Cr,sp}$								

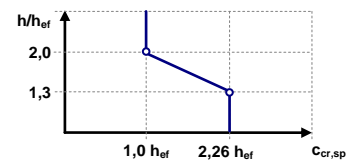
**System iniecyjny Hilti HIT-RE 500 V4****Charakterystyki**

Podstawowe charakterystyki pod wpływem obciążeń rozciągających w betonie.

Załącznik C1

Tabela C2: ciąg dalszy (1)

Metryczny pręt gwintowany według Załącznika A				M8	M10	M12	M16	M20	M24	M27	M30
Kombinacja wyciągnięcia kotwy i wyłamania stożka betonu dla okresu użytkowania 50 lat											
Nośność charakterystyczna w betonie niezarysowanym klasy C20/25 w otworach wierconych udarowo oraz w otworach wierconych udarowo przy użyciu wiertel rurowych Hilti TE-CD lub TE-YD oraz w otworach wierconych techniką diamentową rdzeniową z szorstkowaniem przy użyciu narzędzia do szorstkowania Hilti TE-YRT											
Zakres temperatur I:	24°C / 40°C	$\tau_{Rk,100,ucr}$	[N/mm ²]	19	18	18	17	16	15	15	14
Zakres temperatur II:	43°C / 55°C	$\tau_{Rk,100,ucr}$	[N/mm ²]	16	15	15	14	13	13	12	12
Zakres temperatur III:	55°C / 75°C	$\tau_{Rk,100,ucr}$	[N/mm ²]	6,0	6,0	6,0	5,5	5,0	5,0	4,5	4,5
Nośność charakterystyczna w betonie niezarysowanym klasy C20/25 w otworach wierconych techniką diamentową rdzeniową											
Zakres temperatur I:	24°C / 40°C	$\tau_{Rk,100,ucr}$	[N/mm ²]	13	13	13	13	12	12	12	12
Zakres temperatur II:	43°C / 55°C	$\tau_{Rk,100,ucr}$	[N/mm ²]	12	12	11	11	11	11	11	10
Zakres temperatur II:	55°C / 75°C	$\tau_{Rk,100,ucr}$	[N/mm ²]	6,0	5,5	5,5	5,5	5,5	5,5	5,5	5,0
Nośność charakterystyczna w betonie niezarysowanym klasy C20/25 w otworach wierconych udarowo oraz dla montażu w otworach wypełnionych wodą											
Zakres temperatur I:	24°C / 40°C	$\tau_{Rk,100,ucr}$	[N/mm ²]	16	16	15	15	14	13	12	12
Zakres temperatur II:	43°C / 55°C	$\tau_{Rk,100,ucr}$	[N/mm ²]	13	13	13	12	11	11	10	10
Zakres temperatur II:	55°C / 75°C	$\tau_{Rk,100,ucr}$	[N/mm ²]	5,0	5,0	5,0	4,5	4,5	4,0	4,0	4,0
Nośność charakterystyczna w betonie zarysowanym klasy C20/25 w otworach wierconych udarowo oraz w otworach wierconych udarowo przy użyciu wiertel rurowych Hilti TE-CD lub TE-YD oraz w otworach wierconych techniką diamentową rdzeniową z szorstkowaniem przy użyciu narzędzia do szorstkowania Hilti TE-YRT											
Zakres temperatur I:	24°C / 40°C	$\tau_{Rk,100,cr}$	[N/mm ²]	7,0	8,0	9,0	8,5	8,0	7,5	7,0	6,5
Zakres temperatur II:	43°C / 55°C	$\tau_{Rk,100,cr}$	[N/mm ²]	6,0	7,0	8,0	7,5	7,0	6,5	6,5	6,0
Zakres temperatur II:	55°C / 75°C	$\tau_{Rk,100,cr}$	[N/mm ²]	4,0	3,5	3,5	3,5	3,0	3,0	3,0	3,0
Współczynniki wpływu ψ na nośność wiązania chemicznego $\tau_{Rk,100}$ w betonie zarysowanym i niezarysowanym											
Wpływ wytrzymałości betonu											
w otworach wierconych udarowo oraz w otworach wierconych udarowo przy użyciu wiertel rurowych Hilti TE-CD lub TE-YD oraz w otworach wierconych techniką diamentową rdzeniową											
Zakres temperatur I do III:	ψ_c	[-]		$(f_{ck}/20)^{0,1}$							
w otworach wierconych techniką diamentową rdzeniową z narzędzia do szorstkowania Hilti TE-YRT											
Zakres temperatur I do III:	ψ_c	[-]		2)				1,0			
Wpływ obciążenia długotrwałego											
w otworach wierconych udarowo oraz w otworach wierconych udarowo przy użyciu wiertel rurowych Hilti TE-CD lub TE-YD oraz w otworach wierconych techniką diamentową rdzeniową z szorstkowaniem przy użyciu narzędzia do szorstkowania Hilti TE-YRT											
Zakres temperatur I:	24°C / 40°C	$\psi^0_{sus,100}$	[-]	0,85							
Zakres temperatur II:	43°C / 55°C	$\psi^0_{sus,100}$	[-]	0,72							
Zakres temperatur III:	55°C / 75°C	$\psi^0_{sus,100}$	[-]	0,69							
w otworach wierconych techniką diamentową rdzeniową											
Zakres temperatur I:	24°C / 40°C	$\psi^0_{sus,100}$	[-]	0,70							
Zakres temperatur II:	43°C / 55°C	$\psi^0_{sus,100}$	[-]	0,67							
Zakres temperatur III:	55°C / 75°C	$\psi^0_{sus,100}$	[-]	0,62							

System iniekcyjny Hilti HIT-RE 500 V4

Charakterystyki

Podstawowe charakterystyki pod wpływem obciążeń rozciągających w betonie

Załącznik C2

Tłumaczenie z języka angielskiego na język polski wykonano na zlecenie Hilti (Poland) Sp. z o.o. Wersja uwierzytelniona tłumaczenia dostępna na życzenie.

Tabela C1: ciąg dalszy (2)

Metryczny pręt gwintowany według Załącznika A				M8	M10	M12	M16	M20	M24	M27	M30
Kombinacja wyciągnięcia kotwy i wyłamania stożka betonu dla okresu użytkowania 100 lat											
Nośność charakterystyczna w betonie niezarysowanym klasy C20/25 w otworach wierconych udarowo oraz w otworach wierconych udarowo przy użyciu wiertel rurowych Hilti TE-CD lub TE-YD oraz w otworach wierconych techniką diamentową rdzeniową z szorstkowaniem przy użyciu narzędzia do szorstkowania Hilti TE-YRT											
Zakres temperatur I:	24°C / 40°C	$\tau_{Rk,ucr}$	[N/mm ²]	19	18	18	17	16	15	15	14
Zakres temperatur II:	43°C / 55°C	$\tau_{Rk,ucr}$	[N/mm ²]	15	15	15	14	13	13	12	11
Zakres temperatur III:	55°C / 75°C	$\tau_{Rk,ucr}$	[N/mm ²]	6,0	6,0	6,0	5,5	5,0	5,0	4,5	4,5
Nośność charakterystyczna w betonie niezarysowanym klasy C20/25 w otworach wierconych techniką diamentową rdzeniową											
Zakres temperatur I:	24°C / 40°C	$\tau_{Rk,ucr}$	[N/mm ²]	13	13	13	13	12	12	12	12
Zakres temperatur II:	43°C / 55°C	$\tau_{Rk,ucr}$	[N/mm ²]	12	12	11	11	11	11	11	10
Zakres temperatur II:	55°C / 75°C	$\tau_{Rk,ucr}$	[N/mm ²]	6,0	5,5	5,5	5,5	5,5	5,5	5,5	5,0
Nośność charakterystyczna w betonie niezarysowanym klasy C20/25 w otworach wierconych udarowo oraz dla montażu w otworach wypełnionych wodą											
Zakres temperatur I:	24°C / 40°C	$\tau_{Rk,ucr}$	[N/mm ²]	16	16	15	15	14	13	12	12
Zakres temperatur II:	43°C / 55°C	$\tau_{Rk,ucr}$	[N/mm ²]	13	13	13	12	11	11	10	9,5
Zakres temperatur II:	55°C / 75°C	$\tau_{Rk,ucr}$	[N/mm ²]	5,0	5,0	5,0	4,5	4,5	4,0	4,0	4,0
Nośność charakterystyczna w betonie zarysowanym klasy C20/25 w otworach wierconych udarowo oraz w otworach wierconych udarowo przy użyciu wiertel rurowych Hilti TE-CD lub TE-YD oraz w otworach wierconych techniką diamentową rdzeniową z szorstkowaniem przy użyciu narzędzia do szorstkowania Hilti TE-YRT											
Zakres temperatur I:	24°C / 40°C	$\tau_{Rk,cr}$	[N/mm ²]	7,5	9,0	11	11	10	9,5	9,0	8,5
Zakres temperatur II:	43°C / 55°C	$\tau_{Rk,cr}$	[N/mm ²]	7,0	8,0	9,0	8,5	8,0	8,0	7,5	7,0
Zakres temperatur II:	55°C / 75°C	$\tau_{Rk,cr}$	[N/mm ²]	4,0	3,5	3,5	3,5	3,0	3,0	3,0	3,0
Współczynniki wpływu ψ na nośność wiązania chemicznego τ_{Rk} w betonie zarysowanym i niezarysowanym											
Wpływ wytrzymałości betonu											
w otworach wierconych udarowo oraz w otworach wierconych udarowo przy użyciu wiertel rurowych Hilti TE-CD lub TE-YD oraz w otworach wierconych techniką diamentową rdzeniową											
Zakres temperatur I do III:	ψ_c	[-]		$(f_{ck}/20)^{0,1}$							
w otworach wierconych techniką diamentową rdzeniową z narzędzia do szorstkowania Hilti TE-YRT											
Zakres temperatur I do III:	ψ_c	[-]		2)				1,0			
Wpływ obciążenia długotrwałego											
w otworach wierconych udarowo oraz w otworach wierconych udarowo przy użyciu wiertel rurowych Hilti TE-CD lub TE-YD oraz w otworach wierconych techniką diamentową rdzeniową z szorstkowaniem przy użyciu narzędzia do szorstkowania Hilti TE-YRT											
Zakres temperatur I:	24°C / 40°C	ψ_{sus}^0	[-]	0,88							
Zakres temperatur II:	43°C / 55°C	ψ_{sus}^0	[-]	0,72							
Zakres temperatur III:	55°C / 75°C	ψ_{sus}^0	[-]	0,69							
w otworach wierconych techniką diamentową rdzeniową											
Zakres temperatur I:	24°C / 40°C	ψ_{sus}^0	[-]	0,89							
Zakres temperatur II:	43°C / 55°C	ψ_{sus}^0	[-]	0,70							
Zakres temperatur III:	55°C / 75°C	ψ_{sus}^0	[-]	0,62							

1) W przypadku braku przepisów krajowych.

2) Nie przeprowadzono oceny charakterystyki.

System iniekcyjny Hilti HIT-RE 500 V4

Charakterystyki

Podstawowe charakterystyki pod wpływem obciążeń rozciągających w betonie

Załącznik C3

Tabela C2: Podstawowe charakterystyki dla stalowych prętów gwintowanych według Załącznika A pod wpływem obciążeń rozciągających w betonie

Całowy pręt gwintowany według Załącznika A		3/8	1/2	5/8	3/4	7/8	1	1 1/4
Dla okresu użytkowania 50 lat oraz 100 lat								
Zniszczenie stali								
Nośność charakterystyczna	$N_{Rk,s}$	[kN]	$A_s \cdot f_{uk}$					
Współczynnik częściowy HIT-V	$\gamma_{Ms,N}^{(1)}$	[-]	1,92					
Współczynnik częściowy HAS-V-36	$\gamma_{Ms,N}^{(1)}$	[-]	1,94					
Współczynnik częściowy HAS-E-55	$\gamma_{Ms,N}^{(1)}$	[-]	1,64					
Współczynnik częściowy HAS-B-105	$\gamma_{Ms,N}^{(1)}$	[-]	1,43					
Współczynnik częściowy HAS-R 304	$\gamma_{Ms,N}^{(1)}$	[-]	1,85		2,27		3,01	
Współczynnik częściowy HAS-R-316	$\gamma_{Ms,N}^{(1)}$	[-]	1,85		2,27			
Montażowy współczynnik bezpieczeństwa								
Wiercenie udarowe	γ_{inst}	[-]	1,0					
Wiercenie udarowe przy użyciu wiertel rurowych TE-CD lub TE-YD	γ_{inst}	[-]	2)	1,0				
Wiercenie diamentowe rdzeniowe	γ_{inst}	[-]	1,2		1,4			
Wiercenie diamentowe rdzeniowe z narzędziem do szorstkowania Hilti TE-YRT	γ_{inst}	[-]	2)		1,0			
Wiercenie udarowe w otworach wypełnionych wodą	γ_{inst}	[-]	1,4					
Zniszczenie przez wyłamanie stożka betonu								
Współczynnik dla betonu zarysowanego	$k_{cr,N}$	[-]	7,7					
Współczynnik dla betonu niezarysowanego	$k_{ucr,N}$	[-]	11,0					
Odległość od krawędzi podłoża	$c_{cr,N}$	[mm]	$1,5 \cdot h_{ef}$					
Rozstaw elementów stalowych	$s_{cr,N}$	[mm]	$3,0 \cdot h_{ef}$					
Zniszczenie przez rozłupanie podłoża betonowego								
Odległość od krawędzi podłoża $c_{cr,sp}$ [mm] dla	$h / h_{ef} \geq 2,0$		$1,0 \cdot h_{ef}$					
	$2,0 > h / h_{ef} > 1,3$		$4,6 \cdot h_{ef} - 1,8 \cdot h$					
	$h / h_{ef} \leq 1,3$		$2,26 \cdot h_{ef}$					
Rozstaw elementów stalowych	$s_{cr,sp}$	[mm]	$2 \cdot c_{cr,sp}$					

System iniekcyjny Hilti HIT-RE 500 V4**Charakterystyki**

Podstawowe charakterystyki pod wpływem obciążeń rozciągających w betonie

Załącznik C4

Tabela C2: ciąg dalszy (1)

Gałowy pręt gwintowany według Załącznika A				3/8	1/2	5/8	3/4	7/8	1	1 1/4	
Kombinacja wyciągnięcia kotwy i wyłamania stożka betonu dla okresu użytkowania 50 lat											
Nośność charakterystyczna w betonie niezarysowanym klasy C20/25 w otworach wierconych udarowo oraz w otworach wierconych udarowo przy użyciu wiertel rurowych Hilti TE-CD lub TE-YD oraz w otworach wierconych techniką diamentową rdzeniową z szorstkowaniem przy użyciu narzędzia do szorstkowania Hilti TE-YRT											
Zakres temperatur I:	24°C / 40°C	$\tau_{Rk,100,ucr}$	[N/mm ²]	19	18	17	16	16	15	14	
Zakres temperatur II:	43°C / 55°C	$\tau_{Rk,100,ucr}$	[N/mm ²]	15	15	14	14	13	12	11	
Zakres temperatur III:	55°C / 75°C	$\tau_{Rk,100,ucr}$	[N/mm ²]	6,0	6,0	5,5	5,5	5,0	5,0	4,5	
Nośność charakterystyczna w betonie niezarysowanym klasy C20/25 w otworach wierconych techniką diamentową rdzeniową											
Zakres temperatur I:	24°C / 40°C	$\tau_{Rk,100,ucr}$	[N/mm ²]	13	13	13	12	12	12	12	
Zakres temperatur II:	43°C / 55°C	$\tau_{Rk,100,ucr}$	[N/mm ²]	12	11	11	11	11	11	10	
Zakres temperatur II:	55°C / 75°C	$\tau_{Rk,100,ucr}$	[N/mm ²]	5,5	5,5	5,5	5,5	5,5	5,5	5,0	
Nośność charakterystyczna w betonie niezarysowanym klasy C20/25 w otworach wierconych udarowo oraz dla montażu w otworach wypełnionych wodą											
Zakres temperatur I:	24°C / 40°C	$\tau_{Rk,100,ucr}$	[N/mm ²]	16	15	15	14	13	13	12	
Zakres temperatur II:	43°C / 55°C	$\tau_{Rk,100,ucr}$	[N/mm ²]	13	13	12	12	11	11	9,5	
Zakres temperatur II:	55°C / 75°C	$\tau_{Rk,100,ucr}$	[N/mm ²]	5,0	5,0	4,5	4,5	4,5	4,0	3,5	
Nośność charakterystyczna w betonie zarysowanym klasy C20/25 w otworach wierconych udarowo oraz w otworach wierconych udarowo przy użyciu wiertel rurowych Hilti TE-CD lub TE-YD oraz w otworach wierconych techniką diamentową rdzeniową z szorstkowaniem przy użyciu narzędzia do szorstkowania Hilti TE-YRT											
Zakres temperatur I:	24°C / 40°C	$\tau_{Rk,100,cr}$	[N/mm ²]	9,0	11	11	10	9,0	9,0	8,5	
Zakres temperatur II:	43°C / 55°C	$\tau_{Rk,100,cr}$	[N/mm ²]	8,0	9,0	8,5	8,5	8,0	7,5	7,0	
Zakres temperatur II:	55°C / 75°C	$\tau_{Rk,100,cr}$	[N/mm ²]	3,5	3,5	3,5	3,0	3,0	3,0	2,5	
Współczynniki wpływu ψ na nośność wiązania chemicznego $\tau_{Rk,100}$ w betonie zarysowanym i niezarysowanym											
Wpływ wytrzymałości betonu											
w otworach wierconych udarowo oraz w otworach wierconych udarowo przy użyciu wiertel rurowych Hilti TE-CD lub TE-YD oraz w otworach wierconych techniką diamentową rdzeniową											
Zakres temperatur I do III:	ψ_c	[-]		$(f_{ck}/20)^{0,1}$							
w otworach wierconych techniką diamentową rdzeniową z narzędzia do szorstkowania Hilti TE-YRT											
Zakres temperatur I do III:	ψ_c	[-]		2)			1,0				
Wpływ obciążenia długotrwałego											
w otworach wierconych udarowo oraz w otworach wierconych udarowo przy użyciu wiertel rurowych Hilti TE-CD lub TE-YD oraz w otworach wierconych techniką diamentową rdzeniową z szorstkowaniem przy użyciu narzędzia do szorstkowania Hilti TE-YRT											
Zakres temperatur I:	24°C / 40°C	ψ^0_{sus}	[-]	0,88							
Zakres temperatur II:	43°C / 55°C	ψ^0_{sus}	[-]	0,72							
Zakres temperatur III:	55°C / 75°C	ψ^0_{sus}	[-]	0,69							
w otworach wierconych techniką diamentową rdzeniową											
Zakres temperatur I:	24°C / 40°C	ψ^0_{sus}	[-]	0,89							
Zakres temperatur II:	43°C / 55°C	ψ^0_{sus}	[-]	0,70							
Zakres temperatur III:	55°C / 75°C	ψ^0_{sus}	[-]	0,62							

System iniekcyjny Hilti HIT-RE 500 V4

Charakterystyki

Podstawowe charakterystyki pod wpływem obciążeń rozciągających w betonie

Załącznik C5

Tabela C2: ciąg dalszy (2)

Całowy pręt gwintowany według Załącznika A				3/8	1/2	5/8	3/4	7/8	1	1 1/4
Kombinacja wyciągnięcia kotwy i wyłamania stożka betonu dla okresu użytkowania 100 lat										
Nośność charakterystyczna w betonie niezarysowanym klasy C20/25 w otworach wierconych udarowo oraz w otworach wierconych udarowo przy użyciu wiertel rurowych Hilti TE-CD lub TE-YD oraz w otworach wierconych techniką diamentową rdzeniową z szorstkowaniem przy użyciu narzędzia do szorstkowania Hilti TE-YRT										
Zakres temperatur I:	24°C / 40°C	$\tau_{RK,100,ucr}$	[N/mm ²]	19	18	17	16	16	15	14
Zakres temperatur II:	43°C / 55°C	$\tau_{RK,100,ucr}$	[N/mm ²]	15	15	14	13	13	12	11
Zakres temperatur III:	55°C / 75°C	$\tau_{RK,100,ucr}$	[N/mm ²]	6,0	6,0	5,5	5,5	5,0	5,0	4,5
Nośność charakterystyczna w betonie niezarysowanym klasy C20/25 w otworach wierconych techniką diamentową rdzeniową										
Zakres temperatur I:	24°C / 40°C	$\tau_{RK,100,ucr}$	[N/mm ²]	13	13	13	12	12	12	12
Zakres temperatur II:	43°C / 55°C	$\tau_{RK,100,ucr}$	[N/mm ²]	12	11	11	11	11	11	10
Zakres temperatur II:	55°C / 75°C	$\tau_{RK,100,ucr}$	[N/mm ²]	5,5	5,5	5,5	5,5	5,5	5,5	5,0
Nośność charakterystyczna w betonie niezarysowanym klasy C20/25 w otworach wierconych udarowo oraz dla montażu w otworach wypełnionych wodą										
Zakres temperatur I:	24°C / 40°C	$\tau_{RK,100,ucr}$	[N/mm ²]	16	15	15	14	13	13	12
Zakres temperatur II:	43°C / 55°C	$\tau_{RK,100,ucr}$	[N/mm ²]	13	12	12	11	11	10	9,5
Zakres temperatur II:	55°C / 75°C	$\tau_{RK,100,ucr}$	[N/mm ²]	5,0	5,0	4,5	4,5	4,5	4,0	3,5
Nośność charakterystyczna w betonie zarysowanym klasy C20/25 w otworach wierconych udarowo oraz w otworach wierconych udarowo przy użyciu wiertel rurowych Hilti TE-CD lub TE-YD oraz w otworach wierconych techniką diamentową rdzeniową z szorstkowaniem przy użyciu narzędzia do szorstkowania Hilti TE-YRT										
Zakres temperatur I:	24°C / 40°C	$\tau_{RK,100,cr}$	[N/mm ²]	8,0	8,5	8,5	8,0	7,5	7,5	6,5
Zakres temperatur II:	43°C / 55°C	$\tau_{RK,100,cr}$	[N/mm ²]	7,0	7,5	7,5	7,0	7,0	6,5	6,0
Zakres temperatur II:	55°C / 75°C	$\tau_{RK,100,cr}$	[N/mm ²]	3,5	3,5	3,5	3,0	3,0	3,0	2,5
Współczynniki wpływu ψ na nośność wiązania chemicznego $\tau_{RK,100}$ w betonie zarysowanym i niezarysowanym										
Wpływ wytrzymałości betonu										
w otworach wierconych udarowo oraz w otworach wierconych udarowo przy użyciu wiertel rurowych Hilti TE-CD lub TE-YD oraz w otworach wierconych techniką diamentową rdzeniową										
Zakres temperatur I do III:		ψ_c	[-]	$(f_{ck}/20)^{0,1}$						
w otworach wierconych techniką diamentową rdzeniową z narzędzia do szorstkowania Hilti TE-YRT										
Zakres temperatur I do III:		ψ_c	[-]	2)			1,0			
Wpływ obciążenia długotrwałego										
w otworach wierconych udarowo oraz w otworach wierconych udarowo przy użyciu wiertel rurowych Hilti TE-CD lub TE-YD oraz w otworach wierconych techniką diamentową rdzeniową z szorstkowaniem przy użyciu narzędzia do szorstkowania Hilti TE-YRT										
Zakres temperatur I:	24°C / 40°C	$\psi_{sus,100}^0$	[-]	0,85						
Zakres temperatur II:	43°C / 55°C	$\psi_{sus,100}^0$	[-]	0,72						
Zakres temperatur III:	55°C / 75°C	$\psi_{sus,100}^0$	[-]	0,69						
w otworach wierconych techniką diamentową rdzeniową										
Zakres temperatur I:	24°C / 40°C	$\psi_{sus,100}^0$	[-]	0,70						
Zakres temperatur II:	43°C / 55°C	$\psi_{sus,100}^0$	[-]	0,67						
Zakres temperatur III:	55°C / 75°C	$\psi_{sus,100}^0$	[-]	0,62						

1) W przypadku braku przepisów krajowych.

2) Nie przeprowadzono oceny charakterystyki.

System iniekcyjny Hilti HIT-RE 500 V4

Charakterystyki

Podstawowe charakterystyki pod wpływem obciążeń rozciągających w betonie

Załącznik C6

Tabela C3: Podstawowe charakterystyki dla tulei z gwintem wewnętrznym HIS-(R)N pod wpływem obciążenia rozciągającego w betonie

HIS-(R)N		M8	M10	M12	M16	M20
Średnica zewnętrzna tulei	d_{nom} [mm]	12,5	16,5	20,5	25,4	27,6
Dla okresu użytkowania 50 lat oraz 100 lat						
Zniszczenie stali						
Nośność charakterystyczna tulei HIS-N ze śrubą klasy 8.8	$N_{Rk,s}$ [kN]	25	46	67	125	116
Współczynnik częściowy	$\gamma_{Ms,N}^{1)}$ [-]	1,5				
Nośność charakterystyczna tulei HIS-RN ze śrubą klasy 70	$N_{Rk,s}$ [N/mm ²]	26	41	59	110	166
Współczynnik częściowy	$\gamma_{Ms,N}^{1)}$ [-]	1,87				2,4
Montażowy współczynnik bezpieczeństwa						
Wiercenie udarowe	γ_{inst} [-]	1,0				
Wiercenie udarowe przy użyciu wiertel rurowych Hilti TE-CD lub TE-YD	γ_{inst} [-]	1,0				
Wiercenie diamentowe rdzeniowe	γ_{inst} [-]	1,2	1,4			
Wiercenie diamentowe rdzeniowe z szorstkowaniem narzędziem do szorstkowania Hilti TE-YRT	γ_{inst} [-]	2)	1,0			
Wiercenie udarowe w otworach wypełnionych wodą	γ_{inst} [-]	1,4				
Zniszczenie przez wyłamanie stożka betonu						
Współczynnik dla betonu zarysowanego	$k_{cr,N}$ [-]	7,7				
Współczynnik dla betonu niezarysowanego	$k_{ucr,N}$ [-]	11,0				
Odległość od krawędzi podłoża	$c_{cr,N}$ [mm]	$1,5 \cdot h_{ef}$				
Rozstaw tulei	$s_{cr,N}$ [mm]	$3,0 \cdot h_{ef}$				
Zniszczenie przez rozłupanie podłoża betonowego						
Odległość od krawędzi podłoża $c_{cr,sp}$ [mm] dla	$h / h_{ef} \geq 2,0$	$1,0 \cdot h_{ef}$				
	$2,0 > h / h_{ef} > 1,3$	$4,6 \cdot h_{ef} - 1,8 \cdot h$				
	$h / h_{ef} \leq 1,3$	$2,26 \cdot h_{ef}$				
Rozstaw tulei	$s_{cr,sp}$ [mm]	$2 \cdot c_{cr,sp}$				

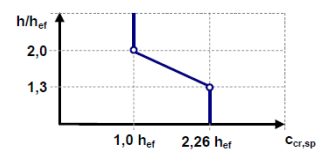
**System iniecyjny Hilti HIT-RE 500 V4****Charakterystyki**

Podstawowe charakterystyki pod wpływem obciążeń rozciągających w betonie.

Załącznik C7

Tabela C3: ciąg dalszy (1)

HIS-(R)N		M8	M10	M12	M16	M20
Średnica zewnętrzna tulei	d_{nom} [mm]	12,5	16,5	20,5	25,4	27,6
Kombinacja wyciągnięcia kotwy i wyłamania stożka betonu dla okresu użytkowania 50 lat						
Nośność charakterystyczna w betonie zarysowanym klasy C20/25 w otworach wierconych udarowo oraz w otworach wierconych udarowo przy użyciu wiertel rurowych Hilti TE-CD lub TE-YD oraz w otworach wierconych techniką diamentową rdzeniową z szorstkowaniem przy użyciu narzędzia do szorstkowania Hilti TE-YRT						
Zakres temperatur I: 24°C / 40°C	$\tau_{Rk,ucr}$ [N/mm ²]	14	14	14	14	14
Zakres temperatur II: 43°C / 55°C	$\tau_{Rk,ucr}$ [N/mm ²]	12	12	12	12	12
Zakres temperatur III: 55°C / 75°C	$\tau_{Rk,ucr}$ [N/mm ²]	4,5	4,5	4,5	4,5	4,5
Nośność charakterystyczna w betonie niezarysowanym klasy C20/25 w otworach wierconych techniką diamentową rdzeniową						
Zakres temperatur I: 24°C / 40°C	$\tau_{Rk,ucr}$ [N/mm ²]	8,5	9,0	9,5	10	10
Zakres temperatur II: 43°C / 55°C	$\tau_{Rk,ucr}$ [N/mm ²]	8,0	8,0	8,5	9,0	9,0
Zakres temperatur III: 55°C / 75°C	$\tau_{Rk,ucr}$ [N/mm ²]	4,0	4,0	4,0	4,5	4,5
Nośność charakterystyczna w betonie niezarysowanym klasy C20/25 w otworach wierconych udarowo oraz dla montażu w otworach wypełnionych wodą						
Zakres temperatur I: 24°C / 40°C	$\tau_{Rk,ucr}$ [N/mm ²]	12	12	12	12	12
Zakres temperatur II: 43°C / 55°C	$\tau_{Rk,ucr}$ [N/mm ²]	10	10	10	10	10
Zakres temperatur III: 55°C / 75°C	$\tau_{Rk,ucr}$ [N/mm ²]	4,0	4,0	4,0	4,0	4,0
Nośność charakterystyczna w betonie zarysowanym klasy C20/25 w otworach wierconych udarowo oraz w otworach wierconych udarowo przy użyciu wiertel rurowych Hilti TE-CD lub TE-YD oraz w otworach wierconych techniką diamentową rdzeniową z szorstkowaniem przy użyciu narzędzia do szorstkowania Hilti TE-YRT						
Zakres temperatur I: 24°C / 40°C	$\tau_{Rk,cr}$ [N/mm ²]	9,0	9,0	9,0	9,0	9,0
Zakres temperatur II: 43°C / 55°C	$\tau_{Rk,cr}$ [N/mm ²]	8,0	8,0	8,0	8,0	8,0
Zakres temperatur III: 55°C / 75°C	$\tau_{Rk,cr}$ [N/mm ²]	3,0	3,0	3,0	3,0	3,0
Współczynniki wpływu ψ na nośność wiązania chemicznego τ_{Rk} w betonie zarysowanym i niezarysowanym						
Wpływ wytrzymałości betonu						
w otworach wierconych udarowo oraz w otworach wierconych udarowo przy użyciu wiertel rurowych Hilti TE-CD lub TE-YD oraz w otworach wierconych techniką diamentową rdzeniową						
Zakres temperatur I do III:	ψ_c [-]	$(f_{ck}/20)^{0,1}$				
w otworach wierconych techniką diamentową rdzeniową z narzędzia do szorstkowania Hilti TE-YRT						
Zakres temperatur I do III:	ψ_c [-]	2)		1,0		
Wpływ obciążenia długotrwałego						
w otworach wierconych udarowo oraz w otworach wierconych udarowo przy użyciu wiertel rurowych Hilti TE-CD lub TE-YD oraz w otworach wierconych techniką diamentową rdzeniową z szorstkowaniem przy użyciu narzędzia do szorstkowania Hilti TE-YRT						
Zakres temperatur I:	24°C / 40°C	ψ^0_{sus} [-]	0,88			
Zakres temperatur II:	43°C / 55°C	ψ^0_{sus} [-]	0,72			
Zakres temperatur III:	55°C / 75°C	ψ^0_{sus} [-]	0,69			
w otworach wierconych techniką diamentową rdzeniową						
Zakres temperatur I:	24°C / 40°C	ψ^0_{sus} [-]	0,89			
Zakres temperatur II:	43°C / 55°C	ψ^0_{sus} [-]	0,70			
Zakres temperatur III:	55°C / 75°C	ψ^0_{sus} [-]	0,62			

System iniekcyjny Hilti HIT-RE 500 V4

Charakterystyki

Podstawowe charakterystyki pod wpływem obciążeń rozciągających w betonie.

Załącznik C8

Tabela C3: ciąg dalszy (2)

HIS-(R)N	M8	M10	M12	M16	M20
Średnica zewnętrzna tulei d_{nom} [mm]	12,5	16,5	20,5	25,4	27,6
Kombinacja wyciągnięcia kotwy i wyłamania stożka betonu dla okresu użytkowania 10 lat					
Nośność charakterystyczna w betonie zarysowanym klasy C20/25 w otworach wierconych udarowo oraz w otworach wierconych udarowo przy użyciu wiertel rurowych Hilti TE-CD lub TE-YD oraz w otworach wierconych techniką diamentową rdzeniową z szorstkowaniem przy użyciu narzędzia do szorstkowania Hilti TE-YRT					
Zakres temperatur I: 24°C / 40°C $\tau_{Rk,100,ucr}$ [N/mm ²]	14	14	14	14	14
Zakres temperatur II: 43°C / 55°C $\tau_{Rk,100,ucr}$ [N/mm ²]	11	11	11	11	11
Zakres temperatur III: 55°C / 75°C $\tau_{Rk,100,ucr}$ [N/mm ²]	4,5	4,5	4,5	4,5	4,5
Nośność charakterystyczna w betonie niezarysowanym klasy C20/25 w otworach wierconych techniką diamentową rdzeniową					
Zakres temperatur I: 24°C / 40°C $\tau_{Rk,100,ucr}$ [N/mm ²]	8,5	9,0	9,5	10	10
Zakres temperatur II: 43°C / 55°C $\tau_{Rk,100,ucr}$ [N/mm ²]	8,0	8,0	8,5	9,0	9,0
Zakres temperatur III: 55°C / 75°C $\tau_{Rk,100,ucr}$ [N/mm ²]	4,0	4,0	4,0	4,5	4,5
Nośność charakterystyczna w betonie niezarysowanym klasy C20/25 w otworach wierconych udarowo oraz dla montażu w otworach wypełnionych wodą					
Zakres temperatur I: 24°C / 40°C $\tau_{Rk,100,ucr}$ [N/mm ²]	12	12	12	12	12
Zakres temperatur II: 43°C / 55°C $\tau_{Rk,100,ucr}$ [N/mm ²]	9,5	9,5	9,5	9,5	9,5
Zakres temperatur III: 55°C / 75°C $\tau_{Rk,100,ucr}$ [N/mm ²]	4,0	4,0	4,0	4,0	4,0
Nośność charakterystyczna w betonie zarysowanym klasy C20/25 w otworach wierconych udarowo oraz w otworach wierconych udarowo przy użyciu wiertel rurowych Hilti TE-CD lub TE-YD oraz w otworach wierconych techniką diamentową rdzeniową z szorstkowaniem przy użyciu narzędzia do szorstkowania Hilti TE-YRT					
Zakres temperatur I: 24°C / 40°C $\tau_{Rk,100,cr}$ [N/mm ²]	7,0	7,0	7,0	7,0	7,0
Zakres temperatur II: 43°C / 55°C $\tau_{Rk,100,cr}$ [N/mm ²]	6,0	6,5	6,5	6,5	6,5
Zakres temperatur III: 55°C / 75°C $\tau_{Rk,100,cr}$ [N/mm ²]	3,0	3,0	3,0	3,0	3,0
Współczynniki wpływu ψ na nośność wiązania chemicznego $\tau_{Rk,100}$ w betonie zarysowanym i niezarysowanym					
Wpływ wytrzymałości betonu					
w otworach wierconych udarowo oraz w otworach wierconych udarowo przy użyciu wiertel rurowych Hilti TE-CD lub TE-YD oraz w otworach wierconych techniką diamentową rdzeniową					
Zakres temperatur I do III: ψ_c [-]	$(f_{ck}/20)^{0,1}$				
w otworach wierconych techniką diamentową rdzeniową z narzędzia do szorstkowania Hilti TE-YRT					
Zakres temperatur I do III: ψ_c [-]	2)		1,0		
Wpływ obciążenia długotrwałego					
w otworach wierconych udarowo oraz w otworach wierconych udarowo przy użyciu wiertel rurowych Hilti TE-CD lub TE-YD oraz w otworach wierconych techniką diamentową rdzeniową z szorstkowaniem przy użyciu narzędzia do szorstkowania Hilti TE-YRT					
Zakres temperatur I: 24°C / 40°C $\psi^0_{sus,100}$ [-]	0,88				
Zakres temperatur II: 43°C / 55°C $\psi^0_{sus,100}$ [-]	0,72				
Zakres temperatur III: 55°C / 75°C $\psi^0_{sus,100}$ [-]	0,69				
w otworach wierconych techniką diamentową rdzeniową					
Zakres temperatur I: 24°C / 40°C $\psi^0_{sus,100}$ [-]	0,70				
Zakres temperatur II: 43°C / 55°C $\psi^0_{sus,100}$ [-]	0,67				
Zakres temperatur III: 55°C / 75°C $\psi^0_{sus,100}$ [-]	0,62				

1) W przypadku braku przepisów krajowych.

2) Nie oceniono charakterystyki.

System iniekcyjny Hilti HIT-RE 500 V4

Charakterystyki

Podstawowe charakterystyki pod wpływem obciążeń rozciągających w betonie.

Załącznik C9

Tabela C4: Podstawowe charakterystyki dla tulei z gwintem wewnętrznym HIS-(R)N pod wpływem obciążeń rozciągających w betonie

HIS-(R)N, rozmiar	[cal]	3/8	1/2	5/8	3/4
Średnica zewnętrzna tulei	d_{nom} [mm]	16,5	20,5	25,4	27,6
Dla okresu użytkowania 50 lat oraz 100 lat					
Zniszczenie stali					
Nośność charakterystyczna tulei HIS-N ze śrubą według SAE J429 klasy 5 lub ASTM A325 (od 1/2 cala do 3/4 cala)	$N_{Rk,s}$ [kN]	41	76	121	130
Współczynnik częściowy	$\gamma_{Ms,N}^{1)}$ [-]	1,57			1,50
Nośność charakterystyczna tulei HIS-N ze śrubą według ASTM A193 klasy B7	$N_{Rk,s}$ [kN]	43	77	128	130
Współczynnik częściowy	$\gamma_{Ms,N}^{1)}$ [-]	1,43	1,50		
Nośność charakterystyczna tulei HIS-RN ze śrubą według ASTM A193 klasy B8M	$N_{Rk,s}$ [kN]	38	110	182	185
Współczynnik częściowy	$\gamma_{Ms,N}^{1)}$ [-]	1,40	2,40		
Nośność charakterystyczna tulei HIS-RN ze śrubą według ASTM A193 klasy B8T	$N_{Rk,s}$ [kN]	43	110	182	185
Współczynnik częściowy	$\gamma_{Ms,N}^{1)}$ [-]	1,50	2,40		
Montażowy współczynnik bezpieczeństwa					
Wiercenie udarowe	γ_{inst} [-]	1,0			
Wiercenie udarowe przy użyciu wiertel rurowych Hilti TE-CD lub TE-YD	γ_{inst} [-]	2)	1,0	2)	
Wiercenie diamentowe rdzeniowe	γ_{inst} [-]	1,4			
Wiercenie diamentowe rdzeniowe z szorstkowaniem narzędziem do szorstkowania Hilti TE-YRT	γ_{inst} [-]	2)	1,0	2)	
Wiercenie udarowe w otworach wypełnionych wodą	γ_{inst} [-]	1,4			
Zniszczenie przez wyłamanie stożka betonu					
Współczynnik dla betonu zarysowanego	$k_{cr,N}$ [-]	7,7			
Współczynnik dla betonu niezarysowanego	$k_{ucr,N}$ [-]	11,0			
Odległość od krawędzi podłoża	$C_{cr,N}$ [mm]	$1,5 \cdot h_{ef}$			
Rozstaw tulei	$S_{cr,N}$ [mm]	$3,0 \cdot h_{ef}$			
Zniszczenie przez rozłupanie podłoża betonowego					
Odległość od krawędzi podłoża $C_{cr,sp}$ [mm] dla	$h / h_{ef} \geq 2,0$	$1,0 \cdot h_{ef}$			
	$2,0 > h / h_{ef} > 1,3$	$4,6 \cdot h_{ef} - 1,8 \cdot h$			
	$h / h_{ef} \leq 1,3$	$2,26 \cdot h_{ef}$			
Rozstaw tulei	$S_{cr,sp}$ [mm]	$2 \cdot C_{cr,sp}$			

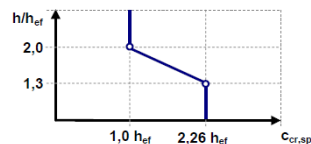

Tłumaczenie z języka angielskiego na język polski wykonano na zlecenie Hilti (Poland) Sp. z o.o. Wersja uwierzytelniona tłumaczenia dostępna na życzenie.

System iniekcyjny Hilti HIT-RE 500 V4

Charakterystyki

Podstawowe charakterystyki pod wpływem obciążeń rozciągających w betonie.

Załącznik C10

Tłumaczenie z języka angielskiego na język polski wykonano na zlecenie Hilti (Poland) Sp. z o.o. Wersja uwierzytelniona tłumaczenia dostępna na życzenie.

Tabela C4: ciąg dalszy (1)

HIS-(R)N, rozmiar		[cal]	3/8	1/2	5/8	3/4
Średnica zewnętrzna tulei	d_{nom}	[mm]	16,5	20,5	25,4	27,6
Kombinacja wyciągnięcia kotwy i wyłamania stożka betonu dla okresu użytkowania 50 lat						
Nośność charakterystyczna w betonie niezarysowanym klasy C20/25 w otworach wierconych udarowo oraz w otworach wierconych udarowo przy użyciu wiertel rurowych Hilti TE-CD lub TE-YD oraz w otworach wierconych techniką diamentową rdzeniową z szorstkowaniem przy użyciu narzędzia do szorstkowania Hilti TE-YRT						
Zakres temperatur I: 24°C / 40°C	$\tau_{Rk,ucr}$	[N/mm ²]	14	14	14	14
Zakres temperatur II: 43°C / 55°C	$\tau_{Rk,ucr}$	[N/mm ²]	12	12	12	12
Zakres temperatur III: 55°C / 75°C	$\tau_{Rk,ucr}$	[N/mm ²]	4,5	4,5	4,5	4,5
Nośność charakterystyczna w betonie niezarysowanym klasy C20/25 w otworach wierconych techniką diamentową rdzeniową						
Zakres temperatur I: 24°C / 40°C	$\tau_{Rk,ucr}$	[N/mm ²]	9,0	9,5	10	10
Zakres temperatur II: 43°C / 55°C	$\tau_{Rk,ucr}$	[N/mm ²]	8,0	8,5	9,0	9,0
Zakres temperatur III: 55°C / 75°C	$\tau_{Rk,ucr}$	[N/mm ²]	4,0	4,0	4,5	4,5
Nośność charakterystyczna w betonie niezarysowanym klasy C20/25 w otworach wierconych udarowo oraz dla montażu w otworach wypełnionych wodą						
Zakres temperatur I: 24°C / 40°C	$\tau_{Rk,ucr}$	[N/mm ²]	12	12	12	12
Zakres temperatur II: 43°C / 55°C	$\tau_{Rk,ucr}$	[N/mm ²]	10	10	10	10
Zakres temperatur III: 55°C / 75°C	$\tau_{Rk,ucr}$	[N/mm ²]	4,0	4,0	4,0	4,0
Nośność charakterystyczna w betonie zarysowanym klasy C20/25 w otworach wierconych udarowo oraz w otworach wierconych udarowo przy użyciu wiertel rurowych Hilti TE-CD lub TE-YD oraz w otworach wierconych techniką diamentową rdzeniową z szorstkowaniem przy użyciu narzędzia do szorstkowania Hilti TE-YRT						
Zakres temperatur I: 24°C / 40°C	$\tau_{Rk,cr}$	[N/mm ²]	9,0	9,0	9,0	9,0
Zakres temperatur II: 43°C / 55°C	$\tau_{Rk,cr}$	[N/mm ²]	8,0	8,0	8,0	8,0
Zakres temperatur III: 55°C / 75°C	$\tau_{Rk,cr}$	[N/mm ²]	3,0	3,0	3,0	3,0
Współczynniki wpływu ψ na nośność wiązania chemicznego τ_{Rk} w betonie zarysowanym i niezarysowanym						
Wpływ wytrzymałości betonu						
w otworach wierconych udarowo oraz w otworach wierconych udarowo przy użyciu wiertel rurowych Hilti TE-CD lub TE-YD oraz w otworach wierconych techniką diamentową rdzeniową						
Zakres temperatur I do III:	ψ_c	[-]	$(f_{ck}/20)^{0,1}$			
w otworach wierconych techniką diamentową rdzeniową z narzędzia do szorstkowania Hilti TE-YRT						
Zakres temperatur I do III:	ψ_c	[-]	2)	1,0	2)	
Wpływ obciążenia długotrwałego						
w otworach wierconych udarowo oraz w otworach wierconych udarowo przy użyciu wiertel rurowych Hilti TE-CD lub TE-YD oraz w otworach wierconych techniką diamentową rdzeniową z szorstkowaniem przy użyciu narzędzia do szorstkowania Hilti TE-YRT						
Zakres temperatur I: 24°C / 40°C	ψ_{sus}^0	[-]	0,88			
Zakres temperatur II: 43°C / 55°C	ψ_{sus}^0	[-]	0,72			
Zakres temperatur III: 55°C / 75°C	ψ_{sus}^0	[-]	0,69			
w otworach wierconych techniką diamentową rdzeniową						
Zakres temperatur I: 24°C / 40°C	ψ_{sus}^0	[-]	0,89			
Zakres temperatur II: 43°C / 55°C	ψ_{sus}^0	[-]	0,70			
Zakres temperatur III: 55°C / 75°C	ψ_{sus}^0	[-]	0,62			

System iniekcyjny Hilti HIT-RE 500 V4

Charakterystyki

Podstawowe charakterystyki pod wpływem obciążeń rozciągających w betonie.

Załącznik C11

Tłumaczenie z języka angielskiego na język polski wykonano na zlecenie Hilti (Poland) Sp. z o.o. Wersja uwierzytelniona tłumaczenia dostępna na życzenie.

Tabela C4: ciąg dalszy (2)

HIS-(R)N, rozmiar		[cal]	3/8	1/2	5/8	3/4
Średnica zewnętrzna tulei	d_{nom}	[mm]	16,5	20,5	25,4	27,6
Kombinacja wyciągnięcia kotwy i wyłamania stożka betonu dla okresu użytkowania 100 lat						
Nośność charakterystyczna w betonie niezarysowanym klasy C20/25 w otworach wierconych udarowo oraz w otworach wierconych udarowo przy użyciu wiertel rurowych Hilti TE-CD lub TE-YD oraz w otworach wierconych techniką diamentową rdzeniową z szorstkowaniem przy użyciu narzędzia do szorstkowania Hilti TE-YRT						
Zakres temperatur I: 24°C / 40°C	$\tau_{Rk,100,ucr}$	[N/mm ²]	14	14	14	14
Zakres temperatur II: 43°C / 55°C	$\tau_{Rk,100,ucr}$	[N/mm ²]	11	11	11	11
Zakres temperatur III: 55°C / 75°C	$\tau_{Rk,100,ucr}$	[N/mm ²]	4,5	4,5	4,5	4,5
Nośność charakterystyczna w betonie niezarysowanym klasy C20/25 w otworach wierconych techniką diamentową rdzeniową						
Zakres temperatur I: 24°C / 40°C	$\tau_{Rk,100,ucr}$	[N/mm ²]	9,0	9,5	10	10
Zakres temperatur II: 43°C / 55°C	$\tau_{Rk,100,ucr}$	[N/mm ²]	8,0	8,5	9,0	9,0
Zakres temperatur III: 55°C / 75°C	$\tau_{Rk,100,ucr}$	[N/mm ²]	4,0	4,0	4,5	4,5
Nośność charakterystyczna w betonie niezarysowanym klasy C20/25 w otworach wierconych udarowo oraz dla montażu w otworach wypełnionych wodą						
Zakres temperatur I: 24°C / 40°C	$\tau_{Rk,100,ucr}$	[N/mm ²]	12	12	12	12
Zakres temperatur II: 43°C / 55°C	$\tau_{Rk,100,ucr}$	[N/mm ²]	9,5	9,5	9,5	9,5
Zakres temperatur III: 55°C / 75°C	$\tau_{Rk,100,ucr}$	[N/mm ²]	4,0	4,0	4,0	4,0
Nośność charakterystyczna w betonie zarysowanym klasy C20/25 w otworach wierconych udarowo oraz w otworach wierconych udarowo przy użyciu wiertel rurowych Hilti TE-CD lub TE-YD oraz w otworach wierconych techniką diamentową rdzeniową z szorstkowaniem przy użyciu narzędzia do szorstkowania Hilti TE-YRT						
Zakres temperatur I: 24°C / 40°C	$\tau_{Rk,100,cr}$	[N/mm ²]	7,0	7,0	7,0	7,0
Zakres temperatur II: 43°C / 55°C	$\tau_{Rk,100,cr}$	[N/mm ²]	6,5	6,5	6,5	6,5
Zakres temperatur III: 55°C / 75°C	$\tau_{Rk,100,cr}$	[N/mm ²]	3,0	3,0	3,0	3,0
Współczynniki wpływu ψ na nośność wiązania chemicznego τ_{Rk} w betonie zarysowanym i niezarysowanym						
Wpływ wytrzymałości betonu						
w otworach wierconych udarowo oraz w otworach wierconych udarowo przy użyciu wiertel rurowych Hilti TE-CD lub TE-YD oraz w otworach wierconych techniką diamentową rdzeniową						
Zakres temperatur I do III:	ψ_c	[-]	$(f_{ck}/20)^{0,1}$			
w otworach wierconych techniką diamentową rdzeniową z narzędzia do szorstkowania Hilti TE-YRT						
Zakres temperatur I do III:	ψ_c	[-]	2)	1,0	2)	
Wpływ obciążenia długotrwałego						
w otworach wierconych udarowo oraz w otworach wierconych udarowo przy użyciu wiertel rurowych Hilti TE-CD lub TE-YD oraz w otworach wierconych techniką diamentową rdzeniową z szorstkowaniem przy użyciu narzędzia do szorstkowania Hilti TE-YRT						
Zakres temperatur I: 24°C / 40°C	$\psi_{sus,100}^0$	[-]	0,85			
Zakres temperatur II: 43°C / 55°C	$\psi_{sus,100}^0$	[-]	0,72			
Zakres temperatur III: 55°C / 75°C	$\psi_{sus,100}^0$	[-]	0,69			
w otworach wierconych techniką diamentową rdzeniową						
Zakres temperatur I: 24°C / 40°C	$\psi_{sus,100}^0$	[-]	0,70			
Zakres temperatur II: 43°C / 55°C	$\psi_{sus,100}^0$	[-]	0,67			
Zakres temperatur III: 55°C / 75°C	$\psi_{sus,100}^0$	[-]	0,62			

¹⁾ W przypadku braku przepisów krajowych.

²⁾ Nie oceniono charakterystyki.

System iniekcyjny Hilti HIT-RE 500 V4

Charakterystyki

Podstawowe charakterystyki pod wpływem obciążeń rozciągających w betonie.

Załącznik C12

Tabela C5: Podstawowe charakterystyki dla kotwy naprężeniowych Hilti HZA / HZA-R pod wpływem obciążenia rozciągającego w betonie

HZA / HZA-R	M12	M16	M20	M24	M27
Średnica pręta zbrojeniowego ϕ [mm]	12	16	20	25	28
Dla okresu użytkowania 50 lat oraz 100 lat					
Zniszczenie stali					
Nośność charakterystyczna HZA $N_{Rk,s}$ [kN]	46	86	135	194	253
Nośność charakterystyczna HZA-R $N_{Rk,s}$ [kN]	62	111	173	248	1)
Współczynnik częściowy γ_{Ms,N^2} [-]	1,4				
Montażowy współczynnik bezpieczeństwa					
Wiercenie udarowe γ_{inst} [-]	1,0				
Wiercenie udarowe przy użyciu wiertel rurowych Hilti TE-CD lub TE-YD γ_{inst} [-]	1,0				
Wiercenie diamentowe rdzeniowe γ_{inst} [-]	1,2	1,4			
Wiercenie diamentowe rdzeniowe z narzędziem do szorstkowania Hilti TE-YRT γ_{inst} [-]	2)	1,0			
Wiercenie udarowe w otworach wypełnianych wodą γ_{inst} [-]	1,4				
Zniszczenie przez wyłamanie stożka betonu					
Czynna głębokość osadzania h_{ef} [mm]	h_{nom}				
Współczynnik dla betonu zarysowanego $k_{Cr,N}$ [-]	7,7				
Współczynnik dla betonu niezarysowanego $k_{Ucr,N}$ [-]	11,0				
Odległość od krawędzi podłoża $c_{Cr,N}$ [mm]	$1,5 \cdot h_{ef}$				
Rozstaw kotew $s_{Cr,N}$ [mm]	$3,0 \cdot h_{ef}$				
Zniszczenie przez rozłupanie podłoża betonowego					
Odległość od krawędzi podłoża $c_{Cr,sp}$ [mm] dla	$h / h_{ef} \geq 2,0$	$1,0 \cdot h_{ef}$			
	$2,0 > h / h_{ef} > 1,3$	$4,6 \cdot h_{ef} - 1,8 \cdot h$			
	$h / h_{ef} \leq 1,3$	$2,26 \cdot h_{ef}$			
Rozstaw kotew $s_{Cr,sp}$ [mm]	$2 \cdot c_{Cr,sp}$				

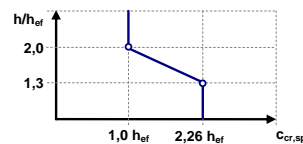

1) W przypadku braku przepisów krajowych.

2) Nie oceniono charakterystyki.

System iniekcyjny Hilti HIT-RE 500 V4**Charakterystyki**

Podstawowe charakterystyki pod wpływem obciążeń rozciągających w betonie.

Załącznik C13

Tłumaczenie z języka angielskiego na język polski wykonano na zlecenie Hilti (Poland) Sp. z o.o. Wersja uwierzytelniona tłumaczenia dostępna na życzenie.

Tabela C5: ciąg dalszy (1)

HZA / HZA-R				M12	M16	M20	M24	M27
Średnica pręta zbrojeniowego	ϕ	[mm]		12	16	20	25	28
Kombinacja wyciągnięcia kotwy i wyłamania stożka betonu dla okresu użytkowania 50 lat								
Nośność charakterystyczna w betonie niezarysowanym klasy C20/25 w otworach wierconych udarowo oraz w otworach wierconych udarowo przy użyciu wiertel rurowych Hilti TE-CD lub TE-YD oraz w otworach wierconych techniką diamentową rdzeniową z szorstkowaniem przy użyciu narzędzia do szorstkowania Hilti TE-YRT								
Zakres temperatur I:	24°C / 40°C	$\tau_{Rk,ucr}$	[N/mm ²]	15	15	14	14	14
Zakres temperatur II:	43°C / 55°C	$\tau_{Rk,ucr}$	[N/mm ²]	12	12	12	11	11
Zakres temperatur II:	55°C / 75°C	$\tau_{Rk,ucr}$	[N/mm ²]	5,0	4,5	4,5	4,5	4,5
Nośność charakterystyczna w betonie niezarysowanym klasy C20/25 w otworach wierconych techniką diamentową rdzeniową								
Zakres temperatur I:	24°C / 40°C	$\tau_{Rk,ucr}$	[N/mm ²]	9,5	9,5	9,5	9,5	10
Zakres temperatur II:	43°C / 55°C	$\tau_{Rk,ucr}$	[N/mm ²]	8,5	8,5	8,5	8,5	8,5
Zakres temperatur II:	55°C / 75°C	$\tau_{Rk,ucr}$	[N/mm ²]	4,0	4,0	4,0	4,5	4,5
Nośność charakterystyczna w betonie niezarysowanym klasy C20/25 w otworach wierconych udarowo oraz dla montażu w otworach wypełnionych wodą								
Zakres temperatur I:	24°C / 40°C	$\tau_{Rk,ucr}$	[N/mm ²]	13	12	12	12	12
Zakres temperatur II:	43°C / 55°C	$\tau_{Rk,ucr}$	[N/mm ²]	11	10	10	10	9,5
Zakres temperatur II:	55°C / 75°C	$\tau_{Rk,ucr}$	[N/mm ²]	4,0	4,0	4,0	4,0	3,5
Nośność charakterystyczna w betonie zarysowanym klasy C20/25 w otworach wierconych udarowo oraz w otworach wierconych udarowo przy użyciu wiertel rurowych Hilti TE-CD lub TE-YD oraz w otworach wierconych techniką diamentową rdzeniową z szorstkowaniem przy użyciu narzędzia do szorstkowania Hilti TE-YRT								
Zakres temperatur I:	24°C / 40°C	$\tau_{Rk,cr}$	[N/mm ²]	12	12	12	11	11
Zakres temperatur II:	43°C / 55°C	$\tau_{Rk,cr}$	[N/mm ²]	10	10	10	9,5	9,5
Zakres temperatur II:	55°C / 75°C	$\tau_{Rk,cr}$	[N/mm ²]	4,0	4,0	3,5	3,5	3,5
Współczynniki wpływu ψ na nośność wiązania chemicznego τ_{Rk} w betonie zarysowanym i niezarysowanym								
Wpływ wytrzymałości betonu								
w otworach wierconych udarowo oraz w otworach wierconych udarowo przy użyciu wiertel rurowych Hilti TE-CD lub TE-YD oraz w otworach wierconych techniką diamentową rdzeniową								
Zakres temperatur I do III:	ψ_c	[-]		$(f_{ck}/20)^{0,1}$				
w otworach wierconych techniką diamentową rdzeniową z narzędzia do szorstkowania Hilti TE-YRT								
Zakres temperatur I do III:	ψ_c	[-]		1)	1,0			
Wpływ obciążenia długotrwałego								
w otworach wierconych udarowo oraz w otworach wierconych udarowo przy użyciu wiertel rurowych Hilti TE-CD lub TE-YD oraz w otworach wierconych techniką diamentową rdzeniową z szorstkowaniem przy użyciu narzędzia do szorstkowania Hilti TE-YRT								
Zakres temperatur I:	24°C / 40°C	ψ_{sus}^0	[-]	0,85				
Zakres temperatur II:	43°C / 55°C	ψ_{sus}^0	[-]	0,72				
Zakres temperatur III:	55°C / 75°C	ψ_{sus}^0	[-]	0,69				
w otworach wierconych techniką diamentową rdzeniową								
Zakres temperatur I:	24°C / 40°C	ψ_{sus}^0	[-]	0,70				
Zakres temperatur II:	43°C / 55°C	ψ_{sus}^0	[-]	0,67				
Zakres temperatur III:	55°C / 75°C	ψ_{sus}^0	[-]	0,62				

System iniekcyjny Hilti HIT-RE 500 V4

Charakterystyki

Podstawowe charakterystyki pod wpływem obciążeń rozciągających w betonie.

Załącznik C14

Tłumaczenie z języka angielskiego na język polski wykonano na zlecenie Hilti (Poland) Sp. z o.o. Wersja uwierzytelniona tłumaczenia dostępna na życzenie.

Tabela C5: ciąg dalszy (2)

HZA / HZA-R	M12	M16	M20	M24	M27
Średnica pręta zbrojeniowego ϕ [mm]	12	16	20	25	28
Kombinacja wyciągnięcia kotwy i wyłamania stożka betonu dla okresu użytkowania 100 lat					
Nośność charakterystyczna w betonie niezarysowanym klasy C20/25 w otworach wierconych udarowo oraz w otworach wierconych udarowo przy użyciu wiertel rurowych Hilti TE-CD lub TE-YD oraz w otworach wierconych techniką diamentową rdzeniową z szorstkowaniem przy użyciu narzędzia do szorstkowania Hilti TE-YRT					
Zakres temperatur I: 24°C / 40°C	$\tau_{Rk,100,ucr}$ [N/mm ²]	15	15	14	14
Zakres temperatur II: 43°C / 55°C	$\tau_{Rk,100,ucr}$ [N/mm ²]	12	12	12	11
Zakres temperatur II: 55°C / 75°C	$\tau_{Rk,100,ucr}$ [N/mm ²]	5,0	4,5	4,5	4,5
Nośność charakterystyczna w betonie niezarysowanym klasy C20/25 w otworach wierconych techniką diamentową rdzeniową					
Zakres temperatur I: 24°C / 40°C	$\tau_{Rk,100,ucr}$ [N/mm ²]	9,5	9,5	9,5	10
Zakres temperatur II: 43°C / 55°C	$\tau_{Rk,100,ucr}$ [N/mm ²]	8,5	8,5	8,5	8,5
Zakres temperatur II: 55°C / 75°C	$\tau_{Rk,100,ucr}$ [N/mm ²]	4,0	4,0	4,0	4,5
Nośność charakterystyczna w betonie niezarysowanym klasy C20/25 w otworach wierconych udarowo oraz dla montażu w otworach wypełnionych wodą					
Zakres temperatur I: 24°C / 40°C	$\tau_{Rk,100,ucr}$ [N/mm ²]	13	12	12	12
Zakres temperatur II: 43°C / 55°C	$\tau_{Rk,100,ucr}$ [N/mm ²]	10	10	10	9,5
Zakres temperatur II: 55°C / 75°C	$\tau_{Rk,100,ucr}$ [N/mm ²]	4,0	4,0	4,0	3,5
Nośność charakterystyczna w betonie zarysowanym klasy C20/25 w otworach wierconych udarowo oraz w otworach wierconych udarowo przy użyciu wiertel rurowych Hilti TE-CD lub TE-YD oraz w otworach wierconych techniką diamentową rdzeniową z szorstkowaniem przy użyciu narzędzia do szorstkowania Hilti TE-YRT					
Zakres temperatur I: 24°C / 40°C	$\tau_{Rk,100,cr}$ [N/mm ²]	10	9,5	9,5	9,0
Zakres temperatur II: 43°C / 55°C	$\tau_{Rk,100,cr}$ [N/mm ²]	9,0	8,5	8,5	8,0
Zakres temperatur II: 55°C / 75°C	$\tau_{Rk,100,cr}$ [N/mm ²]	4,0	4,0	3,5	3,5
Współczynniki wpływu ψ na nośność wiązania chemicznego $\tau_{Rk,100}$ w betonie zarysowanym i niezarysowanym					
Wpływ wytrzymałości betonu					
w otworach wierconych udarowo oraz w otworach wierconych udarowo przy użyciu wiertel rurowych Hilti TE-CD lub TE-YD oraz w otworach wierconych techniką diamentową rdzeniową					
Zakres temperatur I do III:	ψ_c [-]	$(f_{ck}/20)^{0,1}$			
w otworach wierconych techniką diamentową rdzeniową z narzędzia do szorstkowania Hilti TE-YRT					
Zakres temperatur I do III:	ψ_c [-]	1)	1,0		
Wpływ obciążenia długotrwałego					
w otworach wierconych udarowo oraz w otworach wierconych udarowo przy użyciu wiertel rurowych Hilti TE-CD lub TE-YD oraz w otworach wierconych techniką diamentową rdzeniową z szorstkowaniem przy użyciu narzędzia do szorstkowania Hilti TE-YRT					
Zakres temperatur I: 24°C / 40°C	$\psi_{sus,100}^0$ [-]	0,85			
Zakres temperatur II: 43°C / 55°C	$\psi_{sus,100}^0$ [-]	0,72			
Zakres temperatur III: 55°C / 75°C	$\psi_{sus,100}^0$ [-]	0,69			
w otworach wierconych techniką diamentową rdzeniową					
Zakres temperatur I: 24°C / 40°C	$\psi_{sus,100}^0$ [-]	0,70			
Zakres temperatur II: 43°C / 55°C	$\psi_{sus,100}^0$ [-]	0,67			
Zakres temperatur III: 55°C / 75°C	$\psi_{sus,100}^0$ [-]	0,62			

¹⁾ Nie oceniono charakterystyki.

System iniekcyjny Hilti HIT-RE 500 V4

Charakterystyki

Podstawowe charakterystyki pod wpływem obciążeń rozciągających w betonie.

Załącznik C15

Tabela C6: Podstawowe charakterystyki dla prętów zbrojeniowych pod wpływem obciążenia rozciągającego w betonie

Pręt zbrojeniowy	φ 8	φ 10	φ 12	φ 14	φ 16	φ 18	φ 20	φ 24	φ 25	φ 28	φ 30	φ 32
Dla okresu użytkowania 50 lat oraz 100 lat												
Zniszczenie stali prętów zbrojeniowych												
Nośność charakterystyczna $N_{Rk,s}$ [kN]	$A_s \cdot f_{uk}^{1)}$											
Nośność charakterystyczna Pręt zbrojeniowy B500B według normy DIN 488 ²⁾ $N_{Rk,s}$ [kN]	28	43	62	85	111	140	173	249	270	339	388	442
Współczynnik częściowy Pręt zbrojeniowy B500B według normy DIN 488 ³⁾ $\gamma_{Ms,N^{4)}$ [-]	1,4											
Montażowy współczynnik bezpieczeństwa												
Wiercenie udarowe γ_{inst} [-]	1,0											
Wiercenie udarowe przy użyciu wiertel rurowych Hilti TE-CD lub TE-YD γ_{inst} [-]	1,0											
Wiercenie diamentowe rdzeniowe γ_{inst} [-]	1,2					1,4						
Wiercenie diamentowe rdzeniowe z narzędziem do szorstkowania Hilti TE-YRT γ_{inst} [-]	5)			1,0						5)		
Wiercenie udarowe w otworach wypełnionych wodą γ_{inst} [-]	1,4											
Zniszczenie przez wyłamania stożka betonu												
Współczynnik dla betonu zarysowanego $k_{Cr,N}$ [-]	7,7											
Współczynnik dla betonu niezarysowanego $k_{Ucr,N}$ [-]	11,0											
Odległość od krawędzi podłoża $c_{Cr,N}$ [mm]	$1,5 \cdot h_{ef}$											
Rozstaw prętów zbrojeniowych $s_{Cr,N}$ [mm]	$3,0 \cdot h_{ef}$											
Zniszczenie przez rozłupanie podłoża betonowego												
Odległość od krawędzi podłoża $c_{Cr,sp}$ [mm] dla	$h / h_{ef} \geq 2,0$	$1,0 \cdot h_{ef}$										
	$2,0 > h / h_{ef} > 1,3$	$4,6 \cdot h_{ef} - 1,8 \cdot h$										
	$h / h_{ef} \leq 1,3$	$2,26 \cdot h_{ef}$										
Rozstaw prętów zbrojeniowych $s_{Cr,sp}$ [mm]	$2 \cdot c_{Cr,sp}$											

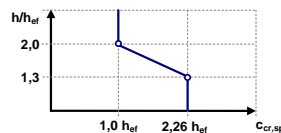

Tłumaczenie z języka angielskiego na język polski wykonano na zlecenie Hilti (Poland) Sp. z o.o. Wersja uwierzytelniona tłumaczenia dostępna na życzenie.

System iniekcyjny Hilti HIT-RE 500 V4

Charakterystyki
Podstawowe charakterystyki pod wpływem obciążeń rozciągających w betonie

Załącznik C16

Tabela C6: ciąg dalszy (1)

Pręt zbrojeniowy	φ 8	φ 10	φ 12	φ 14	φ 16	φ 18	φ 20	φ 24	φ 25	φ 28	φ 30	φ 32		
Kombinacja wyciągnięcia kotwy i wyłamania stożka betonu dla okresu użytkowania 50 lat														
Nośność charakterystyczna w betonie niezarysowanym klasy C20/25 w otworach wierconych udarowo oraz w otworach wierconych udarowo przy użyciu wiertel rurowych Hilti TE-CD lub TE-YD oraz w otworach wierconych techniką diamentową rdzeniową z szorstkowaniem przy użyciu narzędzia do szorstkowania Hilti TE-YRT														
Zakres temperatur I: 24°C / 40°C	$\tau_{Rk,ucr}$ [N/mm ²]	10	15	15	15	15	14	14	14	14	14	13	13	
Zakres temperatur II: 43°C / 55°C	$\tau_{Rk,ucr}$ [N/mm ²]	8,5	13	12	12	12	12	12	12	11	11	11	11	
Zakres temperatur III: 55°C / 75°C	$\tau_{Rk,ucr}$ [N/mm ²]	3,5	5,0	5,0	5,0	4,5	4,5	4,5	4,5	4,5	4,5	4,5	4,5	
Nośność charakterystyczna w betonie niezarysowanym klasy C20/25 w otworach wierconych techniką diamentową rdzeniową														
Zakres temperatur I: 24°C / 40°C	$\tau_{Rk,ucr}$ [N/mm ²]	9,5	9,5	9,5	9,5	9,5	9,5	9,5	9,5	9,5	10	10	10	
Zakres temperatur II: 43°C / 55°C	$\tau_{Rk,ucr}$ [N/mm ²]	8,5	8,5	8,5	8,5	8,5	8,5	8,5	8,5	8,5	8,0	9,0	9,0	
Zakres temperatur III: 55°C / 75°C	$\tau_{Rk,ucr}$ [N/mm ²]	4,0	4,0	4,0	4,0	4,0	4,0	4,0	4,5	4,5	4,5	4,5	4,5	
Nośność charakterystyczna w betonie niezarysowanym klasy C20/25 w otworach wierconych udarowo oraz dla montażu w otworach wypełnionych wodą														
Zakres temperatur I: 24°C / 40°C	$\tau_{Rk,ucr}$ [N/mm ²]	8,5	13	13	13	12	12	12	12	12	12	11	11	
Zakres temperatur II: 43°C / 55°C	$\tau_{Rk,ucr}$ [N/mm ²]	7,0	11	11	10	10	10	10	10	10	9,5	9,5	9,5	
Zakres temperatur III: 55°C / 75°C	$\tau_{Rk,ucr}$ [N/mm ²]	3,0	4,0	4,0	4,0	4,0	4,0	4,0	4,0	4,0	3,5	3,5	3,5	
Nośność charakterystyczna w betonie zarysowanym klasy C20/25 w otworach wierconych udarowo oraz w otworach wierconych udarowo przy użyciu wiertel rurowych Hilti TE-CD lub TE-YD oraz w otworach wierconych techniką diamentową rdzeniową z szorstkowaniem przy użyciu narzędzia do szorstkowania Hilti TE-YRT														
Zakres temperatur I: 24°C / 40°C	$\tau_{Rk,cr}$ [N/mm ²]	5,5	10	12	12	12	12	12	11	11	11	11	11	
Zakres temperatur II: 43°C / 55°C	$\tau_{Rk,cr}$ [N/mm ²]	5,0	8,5	10	10	10	10	10	9,5	9,5	9,5	9,5	9,0	
Zakres temperatur III: 55°C / 75°C	$\tau_{Rk,cr}$ [N/mm ²]	2,0	4,0	4,0	4,0	4,0	4,0	3,5	3,5	3,5	3,5	3,5	3,5	
Współczynniki wpływu ψ na nośność wiązania chemicznego τ_{Rk} w betonie zarysowanym i niezarysowanym														
Wpływ wytrzymałości betonu														
w otworach wierconych udarowo oraz w otworach wierconych udarowo przy użyciu wiertel rurowych Hilti TE-CD lub TE-YD oraz w otworach wierconych techniką diamentową rdzeniową														
Zakres temperatur I do III:	ψ_c	[-]					$(f_{ck}/20)^{0,1}$							
w otworach wierconych techniką diamentową rdzeniową z narzędzia do szorstkowania Hilti TE-YRT														
Zakres temperatur I do III:	ψ_c	[-]					5)		1,0			5)		
Wpływ obciążenia długotrwałego														
w otworach wierconych udarowo oraz w otworach wierconych udarowo przy użyciu wiertel rurowych Hilti TE-CD lub TE-YD oraz w otworach wierconych techniką diamentową rdzeniową z szorstkowaniem przy użyciu narzędzia do szorstkowania Hilti TE-YRT														
Zakres temperatur I: 24°C / 40°C	ψ_{SUS}^0	[-]					0,85							
Zakres temperatur II: 43°C / 55°C	ψ_{SUS}^0	[-]					0,72							
Zakres temperatur III: 55°C / 75°C	ψ_{SUS}^0	[-]					0,69							
w otworach wierconych techniką diamentową rdzeniową														
Zakres temperatur I: 24°C / 40°C	ψ_{SUS}^0	[-]					0,89							
Zakres temperatur II: 43°C / 55°C	ψ_{SUS}^0	[-]					0,70							
Zakres temperatur III: 55°C / 75°C	ψ_{SUS}^0	[-]					0,62							

System iniekcyjny Hilti HIT-RE 500 V4

Charakterystyki

Podstawowe charakterystyki pod wpływem obciążeń rozciągających w betonie

Załącznik C17

Tabela C6: ciąg dalszy (2)

Pręt zbrojeniowy	φ 8	φ 10	φ 12	φ 14	φ 16	φ 18	φ 20	φ 24	φ 25	φ 28	φ 30	φ 32	
Kombinacja wyciągnięcia kotwy i wyłamania stożka betonu dla okresu użytkowania 100 lat													
Nośność charakterystyczna w betonie niezarysowanym klasy C20/25 w otworach wierconych udarowo oraz w otworach wierconych udarowo przy użyciu wiertel rurowych Hilti TE-CD lub TE-YD oraz w otworach wierconych techniką diamentową rdzeniową z szorstkowaniem przy użyciu narzędzia do szorstkowania Hilti TE-YRT													
Zakres temperatur I: 24°C / 40°C $\tau_{Rk,100,ucr}$ [N/mm ²]	10	15	15	15	15	14	14	14	14	14	13	13	
Zakres temperatur II: 43°C / 55°C $\tau_{Rk,100,ucr}$ [N/mm ²]	8,0	12	12	12	12	12	12	11	11	11	11	11	
Zakres temperatur III: 55°C / 75°C $\tau_{Rk,100,ucr}$ [N/mm ²]	3,0	5,0	5,0	5,0	4,5	4,5	4,5	4,5	4,5	4,5	4,5	4,5	
Nośność charakterystyczna w betonie niezarysowanym klasy C20/25 w otworach wierconych techniką diamentową rdzeniową													
Zakres temperatur I: 24°C / 40°C $\tau_{Rk,100,ucr}$ [N/mm ²]	9,5	9,5	9,5	9,5	9,5	9,5	9,5	9,5	9,5	10	10	10	
Zakres temperatur II: 43°C / 55°C $\tau_{Rk,100,ucr}$ [N/mm ²]	8,5	8,5	8,5	8,5	8,5	8,5	8,5	8,5	8,5	8,5	9,0	9,0	
Zakres temperatur III: 55°C / 75°C $\tau_{Rk,100,ucr}$ [N/mm ²]	4,0	4,0	4,0	4,0	4,0	4,0	4,0	4,5	4,5	4,5	4,5	4,5	
Nośność charakterystyczna w betonie niezarysowanym klasy C20/25 w otworach wierconych udarowo oraz dla montażu w otworach wypełnionych wodą													
Zakres temperatur I: 24°C / 40°C $\tau_{Rk,100,ucr}$ [N/mm ²]	8,5	13	13	13	12	12	12	12	12	12	11	11	
Zakres temperatur II: 43°C / 55°C $\tau_{Rk,100,ucr}$ [N/mm ²]	7,0	11	10	10	10	10	10	9,5	9,5	9,5	9,5	9,0	
Zakres temperatur III: 55°C / 75°C $\tau_{Rk,100,ucr}$ [N/mm ²]	2,5	4,0	4,0	4,0	4,0	4,0	4,0	4,0	4,0	3,5	3,5	3,5	
Nośność charakterystyczna w betonie zarysowanym klasy C20/25 w otworach wierconych udarowo oraz w otworach wierconych udarowo przy użyciu wiertel rurowych Hilti TE-CD lub TE-YD oraz w otworach wierconych techniką diamentową rdzeniową z szorstkowaniem przy użyciu narzędzia do szorstkowania Hilti TE-YRT													
Zakres temperatur I: 24°C / 40°C $\tau_{Rk,100,cr}$ [N/mm ²]	5,0	9,0	10	10	9,5	9,5	9,5	9,0	9,0	9,0	9,0	9,0	
Zakres temperatur II: 43°C / 55°C $\tau_{Rk,100,cr}$ [N/mm ²]	4,5	8,0	9,0	9,0	8,5	8,5	8,5	8,0	8,0	8,0	8,0	8,0	
Zakres temperatur III: 55°C / 75°C $\tau_{Rk,100,cr}$ [N/mm ²]	2,0	4,0	4,0	4,0	4,0	4,0	3,5	3,5	3,5	3,5	3,5	3,5	
Współczynniki wpływu ψ na nośność wiązania chemicznego $\tau_{Rk,100}$ w betonie zarysowanym i niezarysowanym													
Wpływ wytrzymałości betonu													
w otworach wierconych udarowo oraz w otworach wierconych udarowo przy użyciu wiertel rurowych Hilti TE-CD lub TE-YD oraz w otworach wierconych techniką diamentową rdzeniową													
Zakres temperatur I do III:	ψ_c	[-]					$(f_{ck}/20)^{0,1}$						
w otworach wierconych techniką diamentową rdzeniową z narzędzia do szorstkowania Hilti TE-YRT													
Zakres temperatur I do III:	ψ_c	[-]					5)		1,0			5)	
Wpływ obciążenia długotrwałego													
w otworach wierconych udarowo oraz w otworach wierconych udarowo przy użyciu wiertel rurowych Hilti TE-CD lub TE-YD oraz w otworach wierconych techniką diamentową rdzeniową z szorstkowaniem przy użyciu narzędzia do szorstkowania Hilti TE-YRT													
Zakres temperatur I: 24°C / 40°C	$\psi_{sus,100}^0$	[-]					0,85						
Zakres temperatur II: 43°C / 55°C	$\psi_{sus,100}^0$	[-]					0,72						
Zakres temperatur III: 55°C / 75°C	$\psi_{sus,100}^0$	[-]					0,69						
w otworach wierconych techniką diamentową rdzeniową													
Zakres temperatur I: 24°C / 40°C	$\psi_{sus,100}^0$	[-]					0,70						
Zakres temperatur II: 43°C / 55°C	$\psi_{sus,100}^0$	[-]					0,67						
Zakres temperatur III: 55°C / 75°C	$\psi_{sus,100}^0$	[-]					0,62						

¹⁾ f_{uk} według specyfikacji technicznej pręta zbrojeniowego.

²⁾ Jeśli pręty zbrojeniowe nie spełniają wymagań normy DIN 488, należy obliczyć wartości według EAD 330499-02, równanie 2.1

³⁾ Jeśli pręty zbrojeniowe nie spełniają wymagań normy DIN 488, wartości należy obliczyć według normy EN 1992-4:2018, tabela 4.1.

⁴⁾ W przypadku braku przepisów krajowych.

⁵⁾ Nie oceniono charakterystyki.

System iniekcyjny Hilti HIT-RE 500 V4

Charakterystyki

Podstawowe charakterystyki pod wpływem obciążeń rozciągających w betonie

Załącznik C18

Tabela C7: Podstawowe charakterystyki dla metrycznych prętów gwintowanych według Załącznika A pod wpływem obciążenia ścinającego w betonie

Metryczny pręt gwintowany według Załącznika A	M8	M10	M12	M16	M20	M24	M27	M30		
Dla okresu użytkowania 50 lat oraz 100 lat										
Zniszczenie stali bez oddziaływania momentu zginającego										
Nośność charakterystyczna	$V_{Rk,s}^0$	[kN]	$k_6 \cdot A_s \cdot f_{uk}$							
Współczynnik dla klasy 5.8	k_6	[-]	0,6							
Współczynnik dla klasy 6.8, 8.8	k_6	[-]	0,5							
Współczynnik HAS A4, HAS-U A4, HIT-V-R, Pręt gwintowany: CRC II oraz III (Tabela 2)	k_6	[-]	0,5							
Współczynnik HAS-U HCR, HIT-V-HCR Pręt gwintowany: CRC V (Tabela 2)	k_6	[-]	0,5							
Współczynnik częściowy, klasa 5.8, 6.8, 8.8	$\gamma_{Ms,v}^{1)}$	[-]	1,25							
Współczynnik częściowy dla HAS A4, HAS-U A4, HIT-V-R, Pręt gwintowany: CRC II oraz III (Tabela 2)	$\gamma_{Ms,v}^{1)}$	[-]	1,56				2,38			
Współczynnik częściowy dla HAS-U HCR, HIT-V-HCR, Pręt gwintowany: CRC V (Tabela 2)	$\gamma_{Ms,v}^{1)}$	[-]	1,25			1,75				
Współczynnik dla ciągliwości	k_7	[-]	1,0							
Zniszczenie stali z oddziaływaniem momentu zginającego										
Charakterystyczny moment zginający	$M_{Rk,s}^0$	[Nm]	$1,2 \cdot W_{el} \cdot f_{uk}$							
Współczynnik dla ciągliwości	k_7	[-]	1,0							
Zniszczenie przez podważenie betonu										
Współczynnik dla podważenia betonu	k_8	[-]	2,0							
Zniszczenie krawędzi podłoża betonowego										
Czynna długość łącznika	l_f	[mm]	min. (h_{ef} ; $12 \cdot d_{nom}$)					min. (h_{ef} ; $8 \cdot d_{nom}$; 300)		
Zewnętrzna średnica łącznika	d_{nom}	[mm]	8	10	12	16	20	24	27	30

¹⁾ W przypadku braku przepisów krajowych.

Injection system Hilti HIT-RE 500 V3

Charakterystyki

Podstawowe charakterystyki pod wpływem obciążeń ścinających w betonie

Annex C19

Tabela C8: Podstawowe charakterystyki dla calowych prętów gwintowanych według Załącznika A pod wpływem obciążeń ścinających w betonie

Calowy pręt gwintowany według Załącznika A			3/8	1/2	5/8	3/4	7/8	1	1 1/4	
Dla okresu użytkowania 50 lat oraz 100 lat										
Zniszczenie stali bez oddziaływania momentu zginającego										
Nośność charakterystyczna	$V_{Rk,s}^0$	[kN]	$k_6 \cdot A_s \cdot f_{uk}$							
Współczynnik dla HIT-V	k_6	[-]	0,6							
Współczynnik dla HAS-E-36	k_6	[-]	0,6							
Współczynnik dla HAS-E-55	k_6	[-]	0,5							
Współczynnik dla HAS-B-105	k_6	[-]	0,5							
Współczynnik dla HAS-R 304	k_6	[-]	0,5							
Współczynnik dla HAS-R 316	k_6	[-]	0,5							
Współczynnik częściowy dla HAS-V	$\gamma_{Ms,v}^1$	[-]	1,60							
Współczynnik częściowy dla HAS-E-36	$\gamma_{Ms,v}^1$	[-]	1,61							
Współczynnik częściowy dla HAS-E-55	$\gamma_{Ms,v}^1$	[-]	1,36							
Współczynnik częściowy dla HAS-B-105	$\gamma_{Ms,v}^1$	[-]	1,50							
Współczynnik częściowy dla HAS-R 304	$\gamma_{Ms,v}^1$	[-]	1,54				1,89		2,51	
Współczynnik częściowy dla HAS-R 316	$\gamma_{Ms,v}^1$	[-]	1,54				1,89			
Współczynnik dla ciągliwości	k_7	[-]	1,0							
Zniszczenie stali z oddziaływaniem momentu zginającego										
Charakterystyczny moment zginający	$M_{Rk,s}^0$	[Nm]	$1,2 \cdot W_{el} \cdot f_{uk}$							
Współczynnik dla ciągliwości	k_7	[-]	1,0							
Zniszczenie przez podważenie betonu										
Współczynnik dla podważenia betonu	k_8	[-]	2,0							
Zniszczenie krawędzi podłoża betonowego										
Czynna długość łącznika	l_f	[mm]	min. ($h_{ef}; 12 \cdot d_{nom}$)						min. ($h_{ef}; 8 \cdot d_{nom}; 300$)	
Zewnętrzna średnica kotwy	d_{nom}	[mm]	9,5	12,7	15,9	19,1	22,2	25,4	31,8	

¹⁾ W przypadku braku przepisów krajowych.

Injection system Hilti HIT-RE 500 V3

Charakterystyki

Podstawowe charakterystyki pod wpływem obciążeń ścinających w betonie

Annex C20

Tabela C9: Podstawowe charakterystyki dla tulei z gwintem wewnętrznym HIS-(R)N pod wpływem obciążenia ścinającego w betonie

HIS-(R)N			M8	M10	M12	M16	M20
Dla okresu użytkowania 50 lat oraz 100 lat							
Zniszczenie stali bez oddziaływania momentu zginającego							
Nośność charakterystyczna	$V_{Rk,s}^0$	[kN]	13	23	34	63	58
Współczynnik częściowy	$\gamma_{Ms,v}^{1)}$	[-]	1,25				
Nośność charakterystyczna HIS-RN ze śrubą ze stali o klasie wytrzymałości 70	$V_{Rk,s}^0$	[kN]	13	20	30	55	83
Współczynnik częściowy	$\gamma_{Ms,v}^{1)}$	[-]	1,56				2,0
Współczynnik dla ciągliwości	k_7	[-]	1,0				
Zniszczenie stali z oddziaływaniem momentu zginającego							
Charakterystyczny moment zginający HIS-N	$M_{Rk,s}^0$	[Nm]	30	60	105	266	519
Charakterystyczny moment zginający HIS-RN	$M_{Rk,s}^0$	[Nm]	26	52	92	233	454
Współczynnik dla ciągliwości	k_7	[-]	1,0				
Zniszczenie przez podważenie betonu							
Współczynnik dla podważenia betonu	k_8	[-]	2,0				
Zniszczenie krawędzi podłoża betonowego							
Czynna długość łącznika	l_f	[mm]	90	110	125	170	205
Zewnętrzna średnica łącznika	d_{nom}	[mm]	12,5	16,5	20,5	25,4	27,6

¹⁾ W przypadku braku przepisów krajowych.

System iniekcyjny Hilti HIT-RE 500 V4

Charakterystyki

Podstawowe charakterystyki pod wpływem obciążeń ścinających w betonie.

Załącznik C21

Tabela C10: Podstawowe charakterystyki dla tulei z gwintem wewnętrznym HIS-(R)N pod wpływem obciążenia ścinającego w betonie

HIS-(R)N, rozmiar	[cal]	3/8	1/2	5/8	3/4
Dla okresu użytkowania 50 lat oraz 100 lat					
Zniszczenie stali bez oddziaływania momentu zginającego					
Nośność charakterystyczna HIS-N Śruba według SAE J429 klasa 5 lub ASTM A325 (od 1/2 cala do 3/4 cala)	$V_{Rk,s}^0$ [kN]	21	38	60	65
Współczynnik częściowy	$\gamma_{Ms,v}^{1)}$ [-]	1,50			1,25
Nośność charakterystyczna HIS-N Śruba według ASTM A193 klasa B7	$V_{Rk,s}^0$ [kN]	22	40	63	65
Współczynnik częściowy	$\gamma_{Ms,v}^{1)}$ [-]	1,50			1,25
Nośność charakterystyczna HIS-RN Śruba według ASTM A193 klasa B8M (AISI 316)	$V_{Rk,s}^0$ [kN]	19	35	55	93
Współczynnik częściowy	$\gamma_{Ms,v}^{1)}$ [-]	1,50			2,00
Nośność charakterystyczna HIS-RN Śruba według ASTM A193 klasa B8T (AISI 316)	$V_{Rk,s}^0$ [kN]	22	40	63	93
Współczynnik częściowy	$\gamma_{Ms,v}^{1)}$ [-]	1,56			2,00
Współczynnik dla ciągliwości	k_7 [-]	1,0			
Zniszczenie stali z oddziaływaniem momentu zginającego					
Charakterystyczny moment zginający HIS-N Śruba według SAE J429 klasa 5 lub ASTM A325 (od 1/2 cali do 3/4 cali)	$M_{Rk,s}^0$ [Nm]	50	123	247	444
Charakterystyczny moment zginający HIS-N Śruba według ASTM A193 klasa B7	$M_{Rk,s}^0$ [Nm]	52	128	257	463
Charakterystyczny moment zginający HIS-RN Śruba według ASTM A193 klasa B8M (AISI 316)	$M_{Rk,s}^0$ [Nm]	45	113	226	407
Charakterystyczny moment zginający HIS-RN Śruba według ASTM A193 klasa B8T (AISI 321)	$M_{Rk,s}^0$ [Nm]	52	128	257	463
Współczynnik dla ciągliwości	k_7 [-]	1,0			
Zniszczenie przez podważenie betonu					
Współczynnik dla podważenia betonu	k_8 [-]	2,0			
Zniszczenie krawędzi podłoża betonowego					
Czynna długość łącznika	l_f [mm]	110	125	170	205
Zewnętrzna średnica łącznika	d_{nom} [mm]	16,5	20,5	25,4	27,6

¹⁾ W przypadku braku przepisów krajowych.

System iniekcyjny Hilti HIT-RE 500 V4

Charakterystyki

Podstawowe charakterystyki pod wpływem obciążeń ścinających w betonie.

Załącznik C22

Tabela C11: Podstawowe charakterystyki dla kotwy naprężeniowej Hilti HZA / HZA-R pod wpływem obciążeń ścinających w betonie

HZA / HZA-R			M12	M16	M20	M24	M27
Średnica pręta zbrojeniowego	ϕ	[mm]	12	16	20	25	28
Dla okresu użytkowania 50 lat oraz 100 lat							
Zniszczenie stali bez oddziaływania momentu zginającego							
Nośność charakterystyczna HZA	$V^{0}_{Rk,s}$	[kN]	23	43	67	97	126
Nośność charakterystyczna HZA-R	$V^{0}_{Rk,s}$	[kN]	31	55	86	124	²⁾
Współczynnik częściowy	$\gamma_{Ms,v}^{1)}$	[-]	1,5				
Współczynnik dla ciągliwości	k_7	[-]	1,0				
Zniszczenie stali z oddziaływaniem momentu zginającego							
Charakterystyczny moment zginający HZA	$M^{0}_{Rk,s}$	[Nm]	72	183	357	617	915
Charakterystyczny moment zginający HZA-R	$M^{0}_{Rk,s}$	[Nm]	97	234	458	790	²⁾
Współczynnik dla ciągliwości	k_7	[-]	1,0				
Zniszczenie przez podważenie betonu							
Współczynnik dla podważenia betonu	k_8	[-]	2,0				
Zniszczenie krawędzi podłoża betonowego							
Czynna długość łącznika	l_f	[mm]	min. ($h_{ef}; 12 \cdot d_{nom}$)			min. ($h_{ef}; 8 \cdot d_{nom}; 300$)	
Zewnętrzna średnica łącznika	d_{nom}	[mm]	12	16	20	24	27

¹⁾ W przypadku braku przepisów krajowych.²⁾ Nie oceniono charakterystyki.**System iniekcyjny Hilti HIT-RE 500 V4****Charakterystyki**

Podstawowe charakterystyki pod wpływem obciążeń ścinających w betonie.

Załącznik C23

Tabela C12: Podstawowe charakterystyki dla prętów zbrojeniowych pod wpływem obciążeń ścinających w betonie

Pręt zbrojeniowy	φ 8	φ 10	φ 12	φ 14	φ 16	φ 18	φ 20	φ 24	φ 25	φ 28	φ 30	φ 32
Dla okresu użytkowania 50 lat oraz 100 lat												
Zniszczenie stali bez oddziaływania momentu zginającego												
Nośność charakterystyczna $V^{0}_{Rk,s}$ [kN]	$0,5 \cdot A_s \cdot f_{uk}^{1)}$											
Nośność charakterystyczna Pręt zbrojeniowy B500B według normy DIN 488 ²⁾ $V^{0}_{Rk,s}$ [kN]	14	22	31	42	55	70	86	124	135	169	194	221
Współczynnik częściowy Pręt zbrojeniowy B500B według normy DIN 488 ³⁾ $\gamma_{Ms,v}^{4)}$ [-]	1,5											
Współczynnik dla ciągliwości k_7 [-]	1,0											
Zniszczenie stali z oddziaływaniem momentu zginającego												
Charakterystyczny moment zginający $M^{0}_{Rk,s}$ [Nm]	$1,2 \cdot W_{el} \cdot f_{uk}^{1)}$											
Charakterystyczny moment zginający Pręt zbrojeniowy B500B według normy DIN 488 $M^{0}_{Rk,s}$ [Nm]	33	65	112	178	265	378	518	896	1012	1422	1749	2123
Współczynnik dla ciągliwości k_7 [-]	1,0											
Zniszczenie przez podważenie betonu												
Współczynnik dla podważenia betonu k_8 [-]	2,0											
Zniszczenie krawędzi podłoża betonowego												
Czynna długość łącznika l_f [mm]	min. ($h_{ef}; 12 \cdot d_{nom}$)						min. ($h_{ef}; 8 \cdot d_{nom}; 300$)					
Zewnętrzna średnica łącznika d_{nom} [mm]	8	10	12	14	16	18	20	24	25	28	30	32

¹⁾ f_{uk} według specyfikacji technicznej pręta zbrojeniowego.²⁾ Jeśli pręty zbrojeniowe nie spełniają wymagań zgodnych z normą DIN 488, wartości należy obliczyć według EAD 330499-02, Równanie 2.1.³⁾ Jeśli pręty zbrojeniowe nie spełniają wymagań zgodnych z normą DIN 488, wartości należy obliczyć według normy EN 1992-4:2018, Tabela 4.1.⁴⁾ W przypadku braku przepisów krajowych.**System iniekcyjny Hilti HIT-RE 500 V4****Charakterystyki**

Podstawowe charakterystyki pod wpływem obciążeń ścinających w betonie

Załącznik C24

Tabela C13: Przemieszczenia dla prętów gwintowanych pod wpływem obciążenia rozciągającego w betonie

Pręt gwintowany, HAS-U-..., HIT-V-..., AM...8.8	M8	M10	M12	M16	M20	M24	M27	M30	
Pręt gwintowany, HAS-..., HIT-V-..., rozmiar	-	3/8	1/2	5/8	3/4	7/8	1	1 1/4	
Przemieszczenie w betonie niezarysowanym									
Zakres temperatur I: 24°C / 40°C	δ_{N0} [mm/(N/mm ²)]	0,04	0,05	0,05	0,06	0,06	0,07	0,08	0,08
	$\delta_{N\infty}$ [mm/(N/mm ²)]	0,10	0,11	0,12	0,13	0,15	0,17	0,18	0,19
Zakres temperatur II: 43°C / 55°C	δ_{N0} [mm/(N/mm ²)]	0,05	0,05	0,06	0,07	0,07	0,08	0,09	0,10
	$\delta_{N\infty}$ [mm/(N/mm ²)]	0,12	0,13	0,14	0,16	0,18	0,20	0,21	0,23
Zakres temperatur III: 55°C / 75°C	δ_{N0} [mm/(N/mm ²)]	0,05	0,06	0,06	0,07	0,08	0,09	0,09	0,10
	$\delta_{N\infty}$ [mm/(N/mm ²)]	0,12	0,13	0,15	0,17	0,19	0,21	0,23	0,24
Przemieszczenie w betonie zarysowanym									
Zakres temperatur I: 24°C / 40°C	δ_{N0} [mm/(N/mm ²)]	0,02	0,03	0,05	0,08	0,10	0,13	0,15	0,18
	$\delta_{N\infty}$ [mm/(N/mm ²)]	0,12	0,19	0,14	0,19	0,16	0,16	0,15	0,18
Zakres temperatur II: 43°C / 55°C	δ_{N0} [mm/(N/mm ²)]	0,02	0,04	0,06	0,09	0,12	0,16	0,18	0,21
	$\delta_{N\infty}$ [mm/(N/mm ²)]	0,15	0,23	0,17	0,23	0,19	0,19	0,18	0,21
Zakres temperatur III: 55°C / 75°C	δ_{N0} [mm/(N/mm ²)]	0,02	0,04	0,06	0,10	0,13	0,17	0,19	0,22
	$\delta_{N\infty}$ [mm/(N/mm ²)]	0,16	0,24	0,18	0,24	0,20	0,20	0,19	0,22

Tabela C14: Przemieszczenia dla tulei z gwintem wewnętrznym HIS-(R)N pod wpływem obciążenia rozciągającego w betonie

HIS-(R)N	M8	M10	M12	M27	M30	
HIS-(R)N, rozmiar [cal]	-	3/8	1/2	5/8	3/4	
Przemieszczenie w betonie niezarysowanym						
Zakres temperatur I: 24°C / 40°C	δ_{N0} [mm/(N/mm ²)]	0,05	0,06	0,06	0,07	0,08
	$\delta_{N\infty}$ [mm/(N/mm ²)]	0,12	0,13	0,15	0,17	0,18
Zakres temperatur II: 43°C / 55°C	δ_{N0} [mm/(N/mm ²)]	0,06	0,07	0,07	0,08	0,09
	$\delta_{N\infty}$ [mm/(N/mm ²)]	0,14	0,16	0,18	0,20	0,21
Zakres temperatur III: 55°C / 75°C	δ_{N0} [mm/(N/mm ²)]	0,06	0,07	0,07	0,09	0,10
	$\delta_{N\infty}$ [mm/(N/mm ²)]	0,15	0,16	0,19	0,21	0,22
Przemieszczenie w betonie zarysowanym						
Zakres temperatur I: 24°C / 40°C	δ_{N0} [mm/(N/mm ²)]	0,02	0,03	0,05	0,08	0,10
	$\delta_{N\infty}$ [mm/(N/mm ²)]	0,12	0,19	0,14	0,19	0,16
Zakres temperatur II: 43°C / 55°C	δ_{N0} [mm/(N/mm ²)]	0,02	0,04	0,06	0,09	0,12
	$\delta_{N\infty}$ [mm/(N/mm ²)]	0,15	0,23	0,17	0,23	0,19
Zakres temperatur III: 55°C / 75°C	δ_{N0} [mm/(N/mm ²)]	0,02	0,04	0,06	0,10	0,13
	$\delta_{N\infty}$ [mm/(N/mm ²)]	0,16	0,24	0,18	0,24	0,20

System iniekcyjny Hilti HIT-RE 500 V4**Charakterystyki**

Przemieszczenia pod wpływem obciążeń rozciągających w betonie

Załącznik C25

Tabela C15: Przeszaczenia dla kotwy naprężeniowej Hilti HZA / HZA-R pod wpływem obciążenia rozciągającego w betonie

HZA / HZA-R		M12	M16	M20	M24	M27
Rozmiar prętów zbrojeniowych	ϕ [mm]	12	16	20	25	28
Przeszaczenie w betonie niezarysowanym						
Zakres temperatur I: 24°C / 40°C	δ_{N0} [mm/(N/mm ²)]	0,05	0,06	0,06	0,07	0,08
	$\delta_{N\infty}$ [mm/(N/mm ²)]	0,12	0,15	0,17	0,18	0,19
Zakres temperatur II: 43°C / 55°C	δ_{N0} [mm/(N/mm ²)]	0,06	0,07	0,09	0,09	0,09
	$\delta_{N\infty}$ [mm/(N/mm ²)]	0,14	0,18	0,20	0,21	0,22
Zakres temperatur III: 55°C / 75°C	δ_{N0} [mm/(N/mm ²)]	0,07	0,08	0,09	0,09	0,10
	$\delta_{N\infty}$ [mm/(N/mm ²)]	0,15	0,19	0,22	0,22	0,23
Przeszaczenie w betonie zarysowanym						
Zakres temperatur I: 24°C / 40°C	δ_{N0} [mm/(N/mm ²)]	0,06	0,10	0,14	0,15	0,16
	$\delta_{N\infty}$ [mm/(N/mm ²)]	0,06	0,16	0,16	0,15	0,16
Zakres temperatur II: 43°C / 55°C	δ_{N0} [mm/(N/mm ²)]	0,07	0,12	0,17	0,17	0,19
	$\delta_{N\infty}$ [mm/(N/mm ²)]	0,07	0,19	0,19	0,18	0,19
Zakres temperatur III: 55°C / 75°C	δ_{N0} [mm/(N/mm ²)]	0,08	0,13	0,17	0,18	0,20
	$\delta_{N\infty}$ [mm/(N/mm ²)]	0,08	0,20	0,20	0,19	0,20

Tabela C16: Przeszaczenia dla prętów zbrojeniowych pod wpływem obciążenia rozciągającego w betonie

Pręt zbrojeniowy		ϕ 8	ϕ 10	ϕ 12	ϕ 14	ϕ 16	ϕ 18
Przeszaczenie w betonie niezarysowanym							
Zakres temperatur I: 24°C / 40°C	δ_{N0} [mm/(N/mm ²)]	0,04	0,05	0,05	0,06	0,06	0,07
	$\delta_{N\infty}$ [mm/(N/mm ²)]	0,10	0,11	0,12	0,13	0,15	0,16
Zakres temperatur II: 43°C / 55°C	δ_{N0} [mm/(N/mm ²)]	0,05	0,05	0,06	0,07	0,07	0,08
	$\delta_{N\infty}$ [mm/(N/mm ²)]	0,12	0,13	0,14	0,16	0,18	0,19
Zakres temperatur III: 55°C / 75°C	δ_{N0} [mm/(N/mm ²)]	0,05	0,06	0,07	0,07	0,08	0,08
	$\delta_{N\infty}$ [mm/(N/mm ²)]	0,12	0,13	0,15	0,17	0,19	0,21
Przeszaczenie w betonie zarysowanym							
Zakres temperatur I: 24°C / 40°C	δ_{N0} [mm/(N/mm ²)]	0,02	0,03	0,06	0,08	0,10	0,11
	$\delta_{N\infty}$ [mm/(N/mm ²)]	0,12	0,19	0,06	0,19	0,16	0,16
Zakres temperatur II: 43°C / 55°C	δ_{N0} [mm/(N/mm ²)]	0,02	0,04	0,07	0,09	0,12	0,14
	$\delta_{N\infty}$ [mm/(N/mm ²)]	0,15	0,23	0,07	0,23	0,19	0,19
Zakres temperatur III: 55°C / 75°C	δ_{N0} [mm/(N/mm ²)]	0,02	0,04	0,08	0,10	0,13	0,14
	$\delta_{N\infty}$ [mm/(N/mm ²)]	0,16	0,24	0,08	0,24	0,20	0,20

System iniekcyjny Hilti HIT-RE 500 V4

Charakterystyki
Przeszaczenia pod wpływem obciążeń rozciągających w betonie

Załącznik C26

Tabela C17: Przemieszczenia dla prętów zbrojeniowych pod wpływem obciążenia rozciągającego w betonie

Pręt zbrojeniowy		φ 20	φ 24	φ 25	φ 28	φ 30	φ 32
Przemieszczenie w betonie niezarysowanym							
Zakres temperatur I: 24°C / 40°C	δ_{N0} [mm/(N/mm ²)]	0,07	0,07	0,07	0,08	0,08	0,08
	$\delta_{N\infty}$ [mm/(N/mm ²)]	0,17	0,19	0,18	0,19	0,19	0,20
Zakres temperatur II: 43°C / 55°C	δ_{N0} [mm/(N/mm ²)]	0,09	0,08	0,09	0,09	0,10	0,10
	$\delta_{N\infty}$ [mm/(N/mm ²)]	0,20	0,21	0,21	0,22	0,23	0,24
Zakres temperatur III: 55°C / 75°C	δ_{N0} [mm/(N/mm ²)]	0,09	0,09	0,09	0,10	0,10	0,11
	$\delta_{N\infty}$ [mm/(N/mm ²)]	0,22	0,22	0,22	0,23	0,24	0,25
Przemieszczenie w betonie zarysowanym							
Zakres temperatur I: 24°C / 40°C	δ_{N0} [mm/(N/mm ²)]	0,14	0,15	0,15	0,16	0,18	0,19
	$\delta_{N\infty}$ [mm/(N/mm ²)]	0,16	0,16	0,15	0,16	0,18	0,19
Zakres temperatur II: 43°C / 55°C	δ_{N0} [mm/(N/mm ²)]	0,17	0,17	0,17	0,19	0,21	0,22
	$\delta_{N\infty}$ [mm/(N/mm ²)]	0,19	0,19	0,18	0,19	0,21	0,22
Zakres temperatur III: 55°C / 75°C	δ_{N0} [mm/(N/mm ²)]	0,17	0,18	0,18	0,20	0,22	0,24
	$\delta_{N\infty}$ [mm/(N/mm ²)]	0,20	0,20	0,19	0,20	0,22	0,24

System iniekcyjny Hilti HIT-RE 500 V4

Charakterystyki

Przemieszczenia pod wpływem obciążeń ścinających w betonie

Załącznik C27

Tabela C18: Przemieszczenia dla prętów gwintowanych pod wpływem obciążenia ścinającego w betonie

Metryczny pręt gwintowany według Załącznika A		M8	M10	M12	M16	M20	M24	M27	M30
Całowy pręt gwintowany według Załącznika A		-	3/8	1/2	5/8	3/4	7/8	1	1 1/4
Przemieszczenie	δ_{v0} [mm/(kN)]	0,06	0,06	0,05	0,04	0,04	0,03	0,03	0,03
	$\delta_{v\infty}$ [mm/(kN)]	0,09	0,08	0,08	0,06	0,06	0,05	0,05	0,05

Tabela C19: Przemieszczenia dla tulei z gwintem wewnętrznym HIS-(R)N pod wpływem obciążenia ścinającego w betonie

HIS-(R)N		M8	M10	M12	M16	M20
HIS-(R)N, rozmiar [cal]		-	3/8	1/2	5/8	3/4
Przemieszczenie	δ_{v0} [mm/(kN)]	0,06	0,06	0,05	0,04	0,04
	$\delta_{v\infty}$ [mm/(kN)]	0,09	0,08	0,08	0,06	0,06

Tabela C20: Przemieszczenia dla kotwy naprężeniowej HZA / HZA-R pod wpływem obciążenia ścinającego w betonie

HZA / HZA-R		M12	M16	M20	M24	M24
Przemieszczenie	δ_{v0} [mm/(kN)]	0,05	0,04	0,04	0,03	0,03
	$\delta_{v\infty}$ [mm/(kN)]	0,08	0,06	0,06	0,05	0,05

Tabela C21: Przemieszczenia dla prętów zbrojeniowych pod wpływem obciążenia ścinającego w betonie

Pręt zbrojeniowy		ϕ 8	ϕ 10	ϕ 12	ϕ 14	ϕ 16	ϕ 18
Przemieszczenie	δ_{v0} [mm/(kN)]	0,05	0,05	0,05	0,04	0,04	0,04
	$\delta_{v\infty}$ [mm/(kN)]	0,08	0,08	0,07	0,06	0,06	0,06

Tabela C22: Przemieszczenia dla prętów zbrojeniowych pod wpływem obciążenia ścinającego w betonie

Pręt zbrojeniowy		ϕ 20	ϕ 24	ϕ 25	ϕ 28	ϕ 30	ϕ 32
Przemieszczenie	δ_{v0} [mm/(kN)]	0,04	0,03	0,03	0,03	0,03	0,03
	$\delta_{v\infty}$ [mm/(kN)]	0,05	0,05	0,05	0,05	0,04	0,04

System iniekcyjny Hilti HIT-RE 500 V4

Charakterystyki
Przemieszczenia pod wpływem obciążeń ścinających w betonie

Załącznik C28

Tabela C23: Podstawowe charakterystyki dla metrycznych prętów gwintowanych według Załącznika A pod wpływem obciążenia rozciągającego dla kategorii sejsmicznej C1 w betonie

Metryczny pręt gwintowany według Załącznika A				M8	M10	M12	M16	M20	M24	M27	M30
Dla okresu użytkowania 50 lat oraz 100 lat											
Zniszczenie stali											
Nośność charakterystyczna $N_{Rk,s,C1}$ [kN]				$A_s \cdot f_{uk}$							
Zniszczenie przez kombinację wyciągnięcia kotwy i wyłamania stożka betonu dla okresu użytkowania 50 lat											
Nośność charakterystyczna w betonie zarysowanym klasy C20/25 w otworach wierconych udarowo oraz w otworach wierconych udarowo przy użyciu wiertel rurowych Hilti TE-CD lub TE-YD oraz w otworach wierconych techniką diamentową rdzeniową z szorstkowaniem przy użyciu narzędzia do szorstkowania Hilti TE-YRT											
Zakres temperatur I:	24°C / 40°C	$\tau_{Rk,C1}$	[N/mm ²]	6,8	8,2	10,1	10,5	9,7	9,4	9,0	8,5
Zakres temperatur II:	43°C / 55°C	$\tau_{Rk,C1}$	[N/mm ²]	6,3	7,3	8,3	8,1	7,8	7,9	7,5	7,0
Zakres temperatur III:	55°C / 75°C	$\tau_{Rk,C1}$	[N/mm ²]	3,6	3,2	3,2	3,3	2,9	3,0	3,0	3,0
Zniszczenie przez kombinację wyciągnięcia kotwy i wyłamania stożka betonu dla okresu użytkowania 100 lat											
Nośność charakterystyczna w betonie zarysowanym klasy C20/25 w otworach wierconych udarowo oraz w otworach wierconych udarowo przy użyciu wiertel rurowych Hilti TE-CD lub TE-YD oraz w otworach wierconych techniką diamentową rdzeniową z szorstkowaniem przy użyciu narzędzia do szorstkowania Hilti TE-YRT											
Zakres temperatur I:	24°C / 40°C	$\tau_{Rk,100,C1}$	[N/mm ²]	6,3	7,3	8,3	8,1	7,8	7,4	7,0	6,5
Zakres temperatur II:	43°C / 55°C	$\tau_{Rk,100,C1}$	[N/mm ²]	5,4	6,4	7,4	7,1	6,8	6,4	6,5	6,0
Zakres temperatur III:	55°C / 75°C	$\tau_{Rk,100,C1}$	[N/mm ²]	3,6	3,2	3,2	3,3	2,9	3,0	3,0	3,0
Współczynniki wpływu ψ na nośność wiązania chemicznego $\tau_{Rk,C1}$ oraz $\tau_{Rk,100,C1}$											
Wpływ wytrzymałości betonu											
Zakres temperatur I do III:				ψ_c		[-]		1,0			

Tabela C24: Podstawowe charakterystyki dla całowych prętów gwintowanych według Załącznika A pod wpływem obciążenia rozciągającego dla kategorii sejsmicznej C1 w betonie

Całowy pręt gwintowany według Załącznika A				3/8	1/2	5/8	3/4	7/8	1	1 1/4
Dla okresu użytkowania 50 lat oraz 100 lat										
Zniszczenie stali										
Nośność charakterystyczna $N_{Rk,s,C1}$ [kN]				$A_s \cdot f_{uk}$						
Zniszczenie przez kombinację wyciągnięcia kotwy i wyłamania stożka betonu dla okresu użytkowania 50 lat										
Nośność charakterystyczna w betonie zarysowanym klasy C20/25 w otworach wierconych udarowo oraz w otworach wierconych udarowo przy użyciu wiertel rurowych Hilti TE-CD lub TE-YD oraz w otworach wierconych techniką diamentową rdzeniową z szorstkowaniem przy użyciu narzędzia do szorstkowania Hilti TE-YRT										
Zakres temperatur I:	24°C / 40°C	$\tau_{Rk,C1}$	[N/mm ²]	8,2	10,1	10,5	9,7	8,9	9,0	8,5
Zakres temperatur II:	43°C / 55°C	$\tau_{Rk,C1}$	[N/mm ²]	7,3	8,3	8,1	8,2	7,9	7,5	7,0
Zakres temperatur III:	55°C / 75°C	$\tau_{Rk,C1}$	[N/mm ²]	3,2	3,2	3,3	2,9	3,0	3,0	2,5
Zniszczenie przez kombinację wyciągnięcia kotwy i wyłamania stożka betonu dla okresu użytkowania 100 lat										
Nośność charakterystyczna w betonie zarysowanym klasy C20/25 w otworach wierconych udarowo oraz w otworach wierconych udarowo przy użyciu wiertel rurowych Hilti TE-CD lub TE-YD oraz w otworach wierconych techniką diamentową rdzeniową z szorstkowaniem przy użyciu narzędzia do szorstkowania Hilti TE-YRT										
Zakres temperatur I:	24°C / 40°C	$\tau_{Rk,100,C1}$	[N/mm ²]	7,3	7,8	8,1	7,8	7,4	7,5	6,5
Zakres temperatur II:	43°C / 55°C	$\tau_{Rk,100,C1}$	[N/mm ²]	6,4	6,9	7,1	6,8	6,9	6,5	6,0
Zakres temperatur III:	55°C / 75°C	$\tau_{Rk,100,C1}$	[N/mm ²]	3,2	3,2	3,3	2,9	3,0	3,0	2,5
Współczynniki wpływu ψ na nośność wiązania chemicznego $\tau_{Rk,C1}$ oraz $\tau_{Rk,100,C1}$										
Wpływ wytrzymałości betonu										
Zakres temperatur I do III:				ψ_c		[-]		1,0		

System iniekcyjny Hilti HIT-RE 500 V4

Charakterystyki

Podstawowe charakterystyki pod wpływem obciążeń rozciągających dla kategorii właściwości sejsmicznych C1 w betonie

Załącznik C29

Tabela C25: Podstawowe charakterystyki dla tulei z gwintem wewnętrznym HIS-(R)N pod wpływem obciążenia rozciągającego dla kategorii sejsmicznej C1 w betonie

HIS-(R)N			M8	M10	M12	M16	M20	
Dla okresu użytkowania 50 lat oraz 100 lat								
Zniszczenie stali								
Nośność charakterystyczna HIS-N	$N_{Rk,s,C1}$	[kN]	25	46	67	125	116	
Nośność charakterystyczna HIS-RN	$N_{Rk,s,C1}$	[kN]	26	41	59	110	166	
Zniszczenie przez kombinację wyciągnięcia kotwy i wyłamania stożka betonu dla okresu użytkowania 50 lat								
Nośność charakterystyczna w betonie zarysowanym klasy C20/25 w otworach wierconych udarowo oraz w otworach wierconych udarowo przy użyciu wiertel rurowych Hilti TE-CD lub TE-YD oraz w otworach wierconych techniką diamentową rdzeniową z szorstkowaniem przy użyciu narzędzia do szorstkowania Hilti TE-YRT								
Zakres temperatur I:	24°C / 40°C	$\tau_{Rk,C1}$	[N/mm ²]	8,4	8,6	8,7	9,0	9,0
Zakres temperatur II:	43°C / 55°C	$\tau_{Rk,C1}$	[N/mm ²]	7,4	7,6	7,8	8,0	8,0
Zakres temperatur III:	55°C / 75°C	$\tau_{Rk,C1}$	[N/mm ²]	2,8	3,3	3,4	3,5	3,5
Zniszczenie przez kombinację wyciągnięcia kotwy i wyłamania stożka betonu dla okresu użytkowania 100 lat								
Nośność charakterystyczna w betonie zarysowanym klasy C20/25 w otworach wierconych udarowo oraz w otworach wierconych udarowo przy użyciu wiertel rurowych Hilti TE-CD lub TE-YD oraz w otworach wierconych techniką diamentową rdzeniową z szorstkowaniem przy użyciu narzędzia do szorstkowania Hilti TE-YRT								
Zakres temperatur I:	24°C / 40°C	$\tau_{Rk,100,C1}$	[N/mm ²]	6,5	6,7	6,8	7,0	7,0
Zakres temperatur II:	43°C / 55°C	$\tau_{Rk,100,C1}$	[N/mm ²]	5,6	6,2	6,3	6,5	6,5
Zakres temperatur III:	55°C / 75°C	$\tau_{Rk,100,C1}$	[N/mm ²]	2,8	2,9	2,9	3,0	3,0
Współczynniki wpływu ψ na nośność wiązania chemicznego $\tau_{Rk,C1}$ oraz $\tau_{Rk,100,C1}$								
Wpływ wytrzymałości betonu								
Zakres temperatur I do III:		ψ_c	[-]					1,0

System iniecyjny Hilti HIT-RE 500 V4

Charakterystyki

Podstawowe charakterystyki pod wpływem obciążeń rozciągających dla kategorii właściwości sejsmicznych C1 w betonie

Załącznik C30

Tabela C26: Podstawowe charakterystyki dla tulei z gwintem wewnętrznym HIS-(R)N pod wpływem obciążenia rozciągającego dla kategorii sejsmicznej C1 w betonie

HIS-(R)N, rozmiar	[cal]		3/8	1/2	5/8	3/4
Dla okresu użytkowania 50 lat oraz 100 lat						
Zniszczenie stali						
Nośność charakterystyczna HIS-N Śruba według SAE J429 Klasa 5 lub ASTM A325 (od 1/2 cala do 3/4 cala)	$N_{Rk,s,C1}$	[kN]	41	76	121	130
Nośność charakterystyczna HIS-N Śruba według ASTM A193 Klasa B7	$N_{Rk,s,C1}$	[kN]	43	77	128	130
Nośność charakterystyczna HIS-RN Śruba według ASTM A193 Klasa B8M (AISI 316)	$N_{Rk,s,C1}$	[kN]	38	110	182	185
Nośność charakterystyczna HIS-RN Śruba według ASTM A193 Klasa B8T (AISI 321)	$N_{Rk,s,C1}$	[kN]	43	110	182	185
Zniszczenie przez kombinację wyciągnięcia kotwy i wyłamania stożka betonu dla okresu użytkowania 50 lat						
Nośność charakterystyczna w betonie zarysowanym klasy C20/25 w otworach wierconych udarowo oraz w otworach wierconych udarowo przy użyciu wiertel rurowych Hilti TE-CD lub TE-YD oraz w otworach wierconych techniką diamentową rdzeniową z szorstkowaniem przy użyciu narzędzia do szorstkowania Hilti TE-YRT						
Zakres temperatur I: 24°C / 40°C	$\tau_{Rk,C1}$	[N/mm ²]	8,6	8,7	9,0	9,0
Zakres temperatur II: 43°C / 55°C	$\tau_{Rk,C1}$	[N/mm ²]	7,6	7,8	8,0	8,0
Zakres temperatur III: 55°C / 75°C	$\tau_{Rk,C1}$	[N/mm ²]	2,9	2,9	3,0	3,0
Zniszczenie przez kombinację wyciągnięcia kotwy i wyłamania stożka betonu dla okresu użytkowania 100 lat						
Nośność charakterystyczna w betonie zarysowanym klasy C20/25 w otworach wierconych udarowo oraz w otworach wierconych udarowo przy użyciu wiertel rurowych Hilti TE-CD lub TE-YD oraz w otworach wierconych techniką diamentową rdzeniową z szorstkowaniem przy użyciu narzędzia do szorstkowania Hilti TE-YRT						
Zakres temperatur I: 24°C / 40°C	$\tau_{Rk,100,C1}$	[N/mm ²]	6,7	6,8	7,0	7,0
Zakres temperatur II: 43°C / 55°C	$\tau_{Rk,100,C1}$	[N/mm ²]	6,2	6,3	6,5	6,5
Zakres temperatur III: 55°C / 75°C	$\tau_{Rk,100,C1}$	[N/mm ²]	2,9	2,9	3,0	3,0
Współczynniki wpływu ψ na nośność wiązania chemicznego $\tau_{Rk,C1}$ oraz $\tau_{Rk,100,C1}$						
Wpływ wytrzymałości betonu						
Zakres temperatur I do III:	ψ_c	[-]	1,0			

System iniekcyjny Hilti HIT-RE 500 V4

Charakterystyki

Podstawowe charakterystyki pod wpływem obciążeń rozciągających dla kategorii właściwości sejsmicznych C1 w betonie

Załącznik C31

Tabela C27: Podstawowe charakterystyki dla kotwy naprężeniowej Hilti HZA / HZA-R pod wpływem obciążenia rozciągającego dla kategorii sejsmicznej C1 w betonie

HZA / HZA-R			M8	M10	M12	M16	M20	
Średnica pręta zbrojeniowego	ϕ	[mm]	12	16	20	25	28	
Dla okresu użytkowania 50 lat oraz 100 lat								
Zniszczenie stali								
Nośność charakterystyczna HZA	$N_{Rk,s,C1}$	[kN]	46	86	135	194	253	
Nośność charakterystyczna HZA-R	$N_{Rk,s,C1}$	[kN]	62	111	173	248	¹⁾	
Zniszczenie przez kombinację wyciągnięcia kotwy i wyłamania stożka betonu dla okresu użytkowania 50 lat								
Nośność charakterystyczna w betonie zarysowanym klasy C20/25 w otworach wierconych udarowo oraz w otworach wierconych udarowo przy użyciu wiertel rurowych Hilti TE-CD lub TE-YD oraz w otworach wierconych techniką diamentową rdzeniową z szorstkowaniem przy użyciu narzędzia do szorstkowania Hilti TE-YRT								
Zakres temperatur I:	24°C / 40°C	$\tau_{Rk,C1}$	[N/mm ²]	11	11,4	11,6	10,9	11
Zakres temperatur II:	43°C / 55°C	$\tau_{Rk,C1}$	[N/mm ²]	9,2	9,5	9,7	9,4	9,5
Zakres temperatur III:	55°C / 75°C	$\tau_{Rk,C1}$	[N/mm ²]	3,7	3,8	3,4	3,5	3,5
Zniszczenie przez kombinację wyciągnięcia kotwy i wyłamania stożka betonu dla okresu użytkowania 100 lat								
Nośność charakterystyczna w betonie zarysowanym klasy C20/25 w otworach wierconych udarowo oraz w otworach wierconych udarowo przy użyciu wiertel rurowych Hilti TE-CD lub TE-YD oraz w otworach wierconych techniką diamentową rdzeniową z szorstkowaniem przy użyciu narzędzia do szorstkowania Hilti TE-YRT								
Zakres temperatur I:	24°C / 40°C	$\tau_{Rk,100,C1}$	[N/mm ²]	9,2	9,0	9,2	8,9	9,0
Zakres temperatur II:	43°C / 55°C	$\tau_{Rk,100,C1}$	[N/mm ²]	8,3	8,1	8,2	7,9	8,0
Zakres temperatur III:	55°C / 75°C	$\tau_{Rk,100,C1}$	[N/mm ²]	3,7	3,8	3,4	3,5	3,5
Współczynniki wpływu ψ na nośność wiązania chemicznego $\tau_{Rk,C1}$ oraz $\tau_{Rk,100,C1}$								
Wpływ wytrzymałości betonu								
Zakres temperatur I do III:	ψ_c		[-]	1,0				

¹⁾ Nie przeprowadzono oceny charakterystyki.

System iniekcyjny Hilti HIT-RE 500 V4

Charakterystyki

Podstawowe charakterystyki pod wpływem obciążeń rozciągających dla kategorii właściwości sejsmicznych C1 w betonie

Załącznik C32

Tabela C28: Podstawowe charakterystyki dla prętów zbrojeniowych pod wpływem obciążenia rozciągającego dla kategorii sejsmicznej C1 w betonie

Pręt zbrojeniowy	φ10	φ12	φ14	φ16	φ18	φ20	φ24	φ25	φ28	φ30	φ32					
Dla okresu użytkowania 50 lat oraz 100 lat																
Zniszczenie stali																
Nośność charakterystyczna	$N_{Rk,s,C1}$ [kN]					$A_s \cdot f_{uk}^{1)}$										
Nośność charakterystyczna, pręt zbrojeniowy B500B według normy DIN 488 ²⁾	$N_{Rk,s,C1}$ [kN]					43	62	85	111	140	173	249	270	339	388	442
Zniszczenie przez kombinację wyciągnięcia kotwy i wyłamania stożka betonu dla okresu użytkowania 50 lat																
Nośność charakterystyczna w betonie zarysowanym klasy C20/25 w otworach wierconych udarowo oraz w otworach wierconych udarowo przy użyciu wiertel rurowych Hilti TE-CD lub TE-YD oraz w otworach wierconych techniką diamentową rdzeniową z szorstkowaniem przy użyciu narzędzia do szorstkowania Hilti TE-YRT																
Zakres temperatur I:	24°C / 40°C	$\tau_{Rk,C1}$	[N/mm ²]	9,1	11,0	11,0	11,4	11,5	11,6	10,8	10,9	11,0	11,0	11,0		
Zakres temperatur II:	43°C / 55°C	$\tau_{Rk,C1}$	[N/mm ²]	7,7	9,2	9,2	9,5	9,6	9,7	9,3	9,4	9,5	9,5	9,0		
Zakres temperatur III:	55°C / 75°C	$\tau_{Rk,C1}$	[N/mm ²]	3,6	3,7	3,7	3,8	3,8	3,4	3,4	3,5	3,5	3,5	3,5		
Zniszczenie przez kombinację wyciągnięcia kotwy i wyłamania stożka betonu dla okresu użytkowania 100 lat																
Nośność charakterystyczna w betonie zarysowanym klasy C20/25 w otworach wierconych udarowo oraz w otworach wierconych udarowo przy użyciu wiertel rurowych Hilti TE-CD lub TE-YD oraz w otworach wierconych techniką diamentową rdzeniową z szorstkowaniem przy użyciu narzędzia do szorstkowania Hilti TE-YRT																
Zakres temperatur I:	24°C / 40°C	$\tau_{Rk,100,C1}$	[N/mm ²]	8,2	9,2	9,2	9,0	9,1	9,2	8,8	8,9	9,0	9,0	9,0		
Zakres temperatur II:	43°C / 55°C	$\tau_{Rk,100,C1}$	[N/mm ²]	7,3	8,3	8,3	8,1	8,2	8,2	7,8	7,9	8,0	8,0	8,0		
Zakres temperatur III:	55°C / 75°C	$\tau_{Rk,100,C1}$	[N/mm ²]	3,6	3,7	3,7	3,8	3,8	3,4	3,4	3,5	3,5	3,5	3,5		
Współczynniki wpływu ψ na nośność wiązania chemicznego $\tau_{Rk,C1}$ oraz $\tau_{Rk,100,C1}$																
Wpływ wytrzymałości betonu																
Zakres temperatur I do III:	ψ_c					[-]						1,0				

¹⁾ f_{uk} według specyfikacji technicznej pręta zbrojeniowego.

²⁾ Jeśli pręty zbrojeniowe nie spełniają wymagań zgodnych z normą DIN 488, wartości należy obliczyć według EAD 330499-02, Równanie 2.1.

Tłumaczenie z języka angielskiego na język polski wykonano na zlecenie Hilti (Poland) Sp. z o.o. Wersja uwierzytelniona tłumaczenia dostępna na życzenie.

System iniekcyjny Hilti HIT-RE 500 V4

Charakterystyki

Podstawowe charakterystyki pod wpływem obciążeń rozciągających dla kategorii właściwości sejsmicznych C1 w betonie

Załącznik C33

Tabela C29: Podstawowe charakterystyki dla metrycznych prętów gwintowanych według Załącznika A pod wpływem obciążenia ścinającego dla kategorii sejsmicznej C1 w betonie

Pręt gwintowany, HAS-U-..., HIT-V-..., AM...8.8	M8	M10	M12	M16	M20	M24	M27	M30	
Dla okresu użytkowania 50 lat oraz 100 lat									
Współczynnik dla pierścieniowej przestrzeni bez zestawu wypełniającego Hilti	α_{gap}	[-]							0,5
Współczynnik dla pierścieniowej przestrzeni z zestawem wypełniającym Hilti	α_{gap}	[-]							1,0
Zniszczenie stali bez oddziaływania momentu zginającego									
Nośność charakterystyczna HAS 5.8, HAS-U-5.8, HIT-V-5.8	$V_{Rk,s,C1}$	[kN]		0,6 · A_s · f_{uk}					
Nośność charakterystyczna HAS 8.8, HAS-U-8.8, HIT-V-8.8, AM...8.8	$V_{Rk,s,C1}$	[kN]		0,5 · A_s · f_{uk}					
Nośność charakterystyczna Pręt zbrojeniowy dostępny w handlu	$V_{Rk,s,C1}$	[kN]		0,35 · A_s · f_{uk}					

¹⁾ Nie przeprowadzono oceny charakterystyki.

Tabela C30: Podstawowe charakterystyki dla całowych prętów gwintowanych według Załącznika A pod wpływem obciążenia ścinającego dla kategorii sejsmicznej C1 w betonie

Pręt gwintowany, HAS-..., HIT-V-..., rozmiar [cal]	3/8	1/2	5/8	3/4	7/8	1	1 1/4	
Dla okresu użytkowania 50 lat oraz 100 lat								
Współczynnik dla pierścieniowej przestrzeni bez zestawu wypełniającego Hilti	α_{gap}	[-]						0,5
Zniszczenie stali bez oddziaływania momentu zginającego								
Nośność charakterystyczna HAS-..., HIT-V...	$V_{Rk,s,C1}$	[kN]		0,5 · A_s · f_{uk}				
Nośność charakterystyczna Pręt zbrojeniowy dostępny w handlu	$V_{Rk,s,C1}$	[kN]		0,35 · A_s · f_{uk}				

Tabela C31: Podstawowe charakterystyki dla tulei z gwintem wewnętrznym HIS-(R)N pod wpływem obciążenia ścinającego dla kategorii sejsmicznej C1 w betonie

HIS-(R)N	M8	M10	M12	M16	M20		
Dla okresu użytkowania 50 lat oraz 100 lat							
Współczynnik dla pierścieniowej przestrzeni bez zestawu wypełniającego Hilti	α_{gap}	[-]				0,5	
Współczynnik dla pierścieniowej przestrzeni z zestawem wypełniającym Hilti	α_{gap}	[-]				1,0	
Zniszczenie stali bez oddziaływania momentu zginającego							
Nośność charakterystyczna HIS-N ze śrubą klasy 8.8	$V_{Rk,s,C1}$	[kN]	9	16	27	41	39
Nośność charakterystyczna HIS-RN ze śrubą klasy 70	$V_{Rk,s,C1}$	[kN]	9	14	21	39	58

System iniekcyjny Hilti HIT-RE 500 V4

Charakterystyki

Podstawowe charakterystyki pod wpływem obciążeń ścinających dla kategorii właściwości sejsmicznych C1 w betonie

Załącznik C34

Tabela C32: Podstawowe charakterystyki dla tulei z gwintem wewnętrznym HIS-(R)N pod wpływem obciążenia ścinającego dla kategorii sejsmicznej C1 w betonie

HIS-(R)N, rozmiar	[cal]	3/8	1/2	5/8	3/4	
Dla okresu użytkowania 50 lat oraz 100 lat						
Współczynnik dla pierścieniowej przestrzeni bez zestawu wypełniającego Hilti	α_{gap}	[-]				0,5
Zniszczenie stali bez oddziaływania momentu zginającego						
Nośność charakterystyczna HIS-N Śruba według SAE J429 Klasa 5 lub ASTM A325 (od 1/2 cala do 3/4 cala)	$V_{Rk,s,C1}$	[kN]	14	27	42	45
Nośność charakterystyczna HIS-N Śruba według ASTM A193 Klasa B7	$V_{Rk,s,C1}$	[kN]	15	28	44	45
Nośność charakterystyczna HIS-RN Śruba według ASTM A193 Klasa B8M (AISI 316)	$V_{Rk,s,C1}$	[kN]	13	24	39	65
Nośność charakterystyczna HIS-RN Śruba według ASTM A193 Klasa B8T (AISI 321)	$V_{Rk,s,C1}$	[kN]	15	28	44	65

Tabela C33: Podstawowe charakterystyki dla kotwy naprężeniowej Hilti HZA / HZA-R pod wpływem obciążenia ścinającego dla kategorii sejsmicznej C1 w betonie

HZA / HZA-R	M12	M16	M20	M24	M27		
Dla okresu użytkowania 50 lat oraz 100 lat							
Współczynnik dla pierścieniowej przestrzeni bez zestawu wypełniającego Hilti	α_{gap}	[-]				0,5	
Zniszczenie stali bez oddziaływania momentu zginającego							
Nośność charakterystyczna HZA	$V_{Rk,s,C1}$	[kN]	23	43	67	97	126
Nośność charakterystyczna HZA-R	$V_{Rk,s,C1}$	[kN]	31	55	86	124	¹⁾

¹⁾ Nie przeprowadzono oceny charakterystyki.**Tabela C34: Podstawowe charakterystyki dla prętów zbrojeniowych pod wpływem obciążenia ścinającego dla kategorii sejsmicznej C1 w betonie**

Pręt zbrojeniowy	ϕ 10	ϕ 12	ϕ 14	ϕ 16	ϕ 18	ϕ 20	ϕ 24	ϕ 25	ϕ 28	ϕ 30	ϕ 32		
Dla okresu użytkowania 50 lat oraz 100 lat													
Zniszczenie stali bez oddziaływania momentu zginającego													
Nośność charakterystyczna	$V_{Rk,s,C1}$	[kN]										$0,35 \cdot A_s \cdot f_{uk}^{1)}$	
Nośność charakterystyczna Pręt zbrojeniowy B500B według normy DIN 488 ²⁾	$V_{Rk,s,C1}$	[kN]	15	22	30	39	49	60	87	95	118	136	155

¹⁾ f_{uk} według specyfikacji technicznej pręta zbrojeniowego.²⁾ Jeśli pręty zbrojeniowe nie spełniają wymagań zgodnych z normą DIN 488, wartości należy obliczyć według EAD 330499-02, Równanie 2.1.

System iniekcyjny Hilti HIT-RE 500 V4

Charakterystyki

Podstawowe charakterystyki pod wpływem obciążeń ścinających dla kategorii właściwości sejsmicznych C1 w betonie

Załącznik C35

Tabela C35: Podstawowe charakterystyki dla metrycznych prętów gwintowanych według Załącznika A pod wpływem obciążenia rozciągającego dla kategorii sejsmicznej C2 w betonie

Metryczny pręt gwintowany według Załącznika A	M12	M16	M20	M24	M27	M30		
Dla okresu użytkowania 50 lat oraz 100 lat								
Nośność charakterystyczna HAS (8.8, 8.8 HDG, A4), HAS-U (8.8, 8.8 HDG, A4, HCR), HIT-V (-8.8, -8.8F, -R, -HCR), AM (8.8, 8.8 HDG), Pręt gwintowany (ocynkowany galwanicznie klasa 8.8, CRC II, CRC III oraz CRC V, patrz→ Tabela A1)	$N_{Rk,s,C2}$ [kN]		$A_s \cdot f_{uk}$					
Zniszczenie przez kombinację wyciągnięcia kotwy i wyłamania stożka betonu dla okresu użytkowania 50 lat								
Nośność charakterystyczna w betonie zarysowanym klasy C20/25 w otworach wierconych udarowo oraz w otworach wierconych udarowo przy użyciu wiertel rurowych Hilti TE-CD lub TE-YD								
Zakres temperatur I: 24°C / 40°C	$\tau_{Rk,C2}$	[N/mm ²]	3,7	6,5	5,8	6,0	5,0	5,2
Zakres temperatur II: 43°C / 55°C	$\tau_{Rk,C2}$	[N/mm ²]	3,1	5,3	4,8	5,0	4,2	4,3
Zakres temperatur III: 55°C / 75°C	$\tau_{Rk,C2}$	[N/mm ²]	1,2	2,1	1,9	1,9	1,6	1,7
Zniszczenie przez kombinację wyciągnięcia kotwy i wyłamania stożka betonu dla okresu użytkowania 100 lat								
Nośność charakterystyczna w betonie zarysowanym klasy C20/25 w otworach wierconych udarowo oraz w otworach wierconych udarowo przy użyciu wiertel rurowych Hilti TE-CD lub TE-YD								
Zakres temperatur I: 24°C / 40°C	$\tau_{Rk,100,C2}$	[N/mm ²]	3,7	6,5	5,8	6,0	5,0	5,2
Zakres temperatur II: 43°C / 55°C	$\tau_{Rk,100,C2}$	[N/mm ²]	3,0	5,3	4,8	4,9	4,1	4,3
Zakres temperatur III: 55°C / 75°C	$\tau_{Rk,100,C2}$	[N/mm ²]	1,2	2,1	1,9	1,9	1,6	1,7
Współczynniki wpływu ψ na nośność wiązania chemicznego $\tau_{Rk,C2}$ oraz $\tau_{Rk,100,C2}$								
Wpływ wytrzymałości betonu								
Zakres temperatur I do III:	ψ_c	[-]	1,0					

Injection system Hilti HIT-RE 500 V4

Charakterystyki

Podstawowe charakterystyki pod wpływem obciążeń rozciągających dla kategorii właściwości sejsmicznych C2 w betonie.

Załącznik C36

Tabela C36: Podstawowe charakterystyki dla metrycznych prętów gwintowanych według Załącznika A pod wpływem obciążenia ścinającego dla kategorii sejsmicznej C2 w betonie

Metryczny pręt gwintowany według Załącznika A	M12	M16	M20	M24	M27	M30
Dla okresu użytkowania 50 lat oraz 100 lat						
Współczynnik dla pierścieniowej przestrzeni bez zestawu wypełniającego Hilti α_{gap} [-]	0,5					
Współczynnik dla pierścieniowej przestrzeni z zestawem wypełniającym Hilti α_{gap} [-]	1,0				1)	
Zniszczenie stali bez oddziaływania momentu zginającego						
Nośność charakterystyczna HAS 8.8, HAS-U 8.8, HIT-V-8.8, AM 8.8 $V_{Rk,s,C2}$ [kN]	28	46	77	103	1)	
Zniszczenie stali z oddziaływaniem momentu zginającego						
Nośność charakterystyczna HAS 8.8, HAS-U 8.8, HIT-V-8.8, AM 8.8 $V_{Rk,s,C2}$ [kN]	24	40	71	90	121	135
Nośność charakterystyczna HAS 8.8, HAS-U 8.8 HDG, HIT-V-8.8F, AM HDG 8.8 $V_{Rk,s,C2}$ [kN]	18	30	46	66	1)	
Nośność charakterystyczna HAS A4, HAS-U A4, HIT-V-R $V_{Rk,s,C2}$ [kN]	21	35	62	79	76	84
Nośność charakterystyczna HAS-U HCR, HIT-V-HCR $V_{Rk,s,C2}$ [kN]	24	40	71	79	106	118
Nośność charakterystyczna Pręt gwintowany klasy 8.8 dostępny w handlu $V_{Rk,s,C2}$ [kN]	17	28	50	63	85	95
Nośność charakterystyczna Pręt gwintowany A4 dostępny w handlu $V_{Rk,s,C2}$ [kN]	15	28	43	55	53	59
Nośność charakterystyczna Pręt gwintowany HCR dostępny w handlu $V_{Rk,s,C2}$ [kN]	17	28	50	55	74	83

1) Nie przeprowadzono oceny charakterystyki.

Injection system Hilti HIT-RE 500 V4

Charakterystyki

Podstawowe charakterystyki pod wpływem obciążeń ścinających dla kategorii właściwości sejsmicznych C2 w betonie

Załącznik C37

Tabela C37: Przeszacowania dla metrycznych prętów gwintowanych według Załącznika A pod wpływem obciążenia rozciągającego dla kategorii sejsmicznej C2 w betonie

Metryczny pręt gwintowany według Załącznika A			M12	M16	M20	M24	M27	M30
Pręt gwintowany, HAS 8.8, HAS-U-..., HIT-V-..., AM...8.8	$\delta_{N,C2(DLS)}$	[mm]	0,2	0,5	0,5	0,4	0,4	0,5
	$\delta_{N,C2(ULS)}$	[mm]	0,6	1,2	0,9	0,8	1,0	0,9

Tabela C38: Przeszacowania dla metrycznych prętów gwintowanych według Załącznika A pod wpływem obciążenia ścinającego dla kategorii sejsmicznej C2 w betonie

Metryczny pręt gwintowany według Załącznika A			M12	M16	M20	M24	M27	M30
Montaż z zestawem wypełniającym Hilti								
HAS 8.8, HAS-U 8.8, HIT-V 8.8, AM 8.8.	$\delta_{V,C2(DLS)}$	[mm]	0,6	1,2	1,4	1,1	1)	
	$\delta_{V,C2(ULS)}$	[mm]	3,1	3,2	3,7	2,6	1)	
Montaż bez zestawu wypełniającego Hilti								
Pręt gwintowany, HAS..., HAS-U-..., HIT-V-..., AM 8.8.	$\delta_{V,C2(DLS)}$	[mm]	1,9	3,2	2,5	3,5	3,0	1,9
	$\delta_{V,C2(ULS)}$	[mm]	4,4	9,2	7,1	10,2	7,2	6,3
HAS 8.8 HDG, HAS-U 8.8 HDG, HIT-V-F 8.8, AM HDG 8.8.	$\delta_{V,C2(DLS)}$	[mm]	2,2	2,3	3,8	3,4	1)	
	$\delta_{V,C2(ULS)}$	[mm]	4,1	4,3	9,1	8,4	1)	

¹⁾ Nie przeprowadzono oceny charakterystyki.

Injection system Hilti HIT-RE 500 V4

Charakterystyki

Przeszacowania dla kategorii sejsmicznej C2 w betonie

Załącznik C38

Charakterystyczna nośność wiązania chemicznego pojedynczego łącznika wklejanego $\tau_{Rk,fi,p}(\theta)$ dla klas wytrzymałości betonu od C20/25 do C50/60 i wszystkich metod wiercenia otworu w warunkach oddziaływania pożaru²

Charakterystyczna nośność wiązania chemicznego pojedynczego łącznika wklejanego w warunkach oddziaływania pożaru $\tau_{Rk,fi,p}(\theta)$ dla danej temperatury (θ) musi być obliczona przy użyciu następujących równań:

Wartości obliczeniowe nośności wiązania chemicznego $f_{bd,fi}$ oraz $f_{bd,fi,100l}$ pod wpływem oddziaływania pożaru musi być obliczona z poniższego równania:

$$\tau_{Rk,fi,p}(\theta) = k_{fi,p}(\theta) \cdot \tau_{Rk,cr,C20/25}$$

gdzie: $\theta \leq \theta_{maks.}$: $k_{fi,p}(\theta) = k_{fi,p,100l}(\theta) = 39,83 \cdot \theta^{-1,266} \leq 1,0$

oraz $\theta < \theta_{maks.}$: $k_{fi,p}(\theta) = k_{fi,p,100l}(\theta) = 0,0$

$\theta_{maks.} = 305 \text{ }^{\circ}\text{C}$

$\tau_{Rk,fi,p}$ = charakterystyczna nośność wiązania chemicznego dla betonu zarysowanego pod wpływem oddziaływania pożaru dla danej temperatury (θ).

$k_{fi,p}(\theta)$ = współczynnik redukcyjny dla nośności wiązania chemicznego pod wpływem oddziaływania pożaru.

$f_{bd,PIR}$ = charakterystyczna nośność wiązania chemicznego dla betonu zarysowanego dla klasy wytrzymałości betonu C20/25 dla odnośnego zakresu temperatury.

Rysunek C5: Współczynnik redukcyjny $k_{fi,p}(\theta)$

Współczynnik redukcyjny dla temperatury

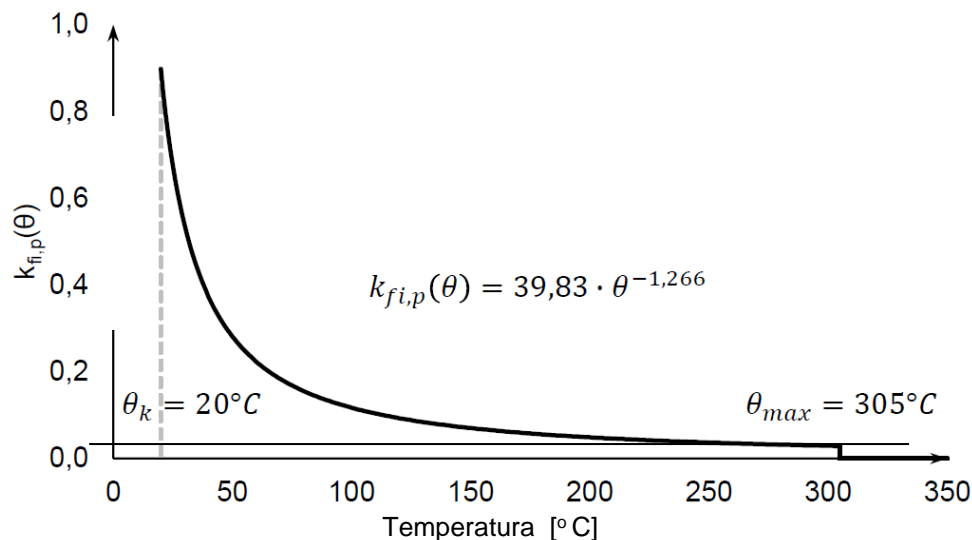

² Charakterystyczną nośność łącznika, grupy łączników oraz łączników rozciąganych z grupy łączników w przypadku kombinacji zniszczenia przez wyciągnięcie i zniszczenia betonu w warunkach oddziaływania pożaru $N_{Rk,p,fi}$ należy przyjąć na podstawie Załącznika B1.

Injection system Hilti HIT-RE 500 V4

Charakterystyki

Współczynnik redukcyjny dla zniszczenia przez wyciągnięcie pojedynczego łącznika w warunkach pożaru

Załącznik C39

Tabela C39: Nośność charakterystyczna pod wpływem obciążenia rozciągającego w przypadku zniszczenia stali w warunkach oddziaływania pożaru

Rozmiar łącznika		M8	M10	M12	M16	M20	M24	M27	M30
HAS 5.8, 5.8 HDG HAS 8.8, 8.8 HDG HAS-U 5.8, 5.8 HDG HAS-U 8.8, 8.8 HDG HIT-V 5.8, 5.8F HIT-V 8.8, 8.8F	$N_{Rk,s,fi(30)}$ [kN]	1,04	1,77	2,76	5,15	8,04	11,58	15,05	18,40
	$N_{Rk,s,fi(60)}$ [kN]	0,81	1,34	2,03	3,79	5,91	8,51	11,07	13,53
	$N_{Rk,s,fi(90)}$ [kN]	0,59	0,91	1,30	2,42	3,78	5,45	7,09	8,66
	$N_{Rk,s,fi(120)}$ [kN]	0,47	0,70	0,94	1,74	2,72	3,92	5,09	6,22
	$N_{Rk,s,fi(30)}$ [kN]	2,67	4,85	7,94	14,78	23,06	33,23	43,21	52,81
HAS A4 HAS-U A4-70 HAS-U HCR	$N_{Rk,s,fi(60)}$ [kN]	1,93	3,44	5,57	10,37	16,18	23,32	30,32	37,06
	$N_{Rk,s,fi(90)}$ [kN]	1,18	2,03	3,20	5,96	9,30	13,40	17,43	21,30
	$N_{Rk,s,fi(120)}$ [kN]	0,80	1,33	2,02	3,76	5,86	8,44	10,98	13,42
	$N_{Rk,s,fi(30)}$ [kN]	2,67	4,85	7,94	14,78	23,06	33,23	43,21	52,81

Tabela C40: Nośność charakterystyczna pod wpływem obciążenia rozciągającego w przypadku zniszczenia stali w warunkach oddziaływania pożaru

Rozmiar łącznika		[cal]	3/8	1/2	5/8	3/4	7/8	1	1 1/4
HAS-E-55 HAS-B-105 (HDG)	$N_{Rk,s,fi(30)}$ [kN]	[kN]	1,50	3,00	4,78	7,08	9,77	12,82	20,50
	$N_{Rk,s,fi(60)}$ [kN]	[kN]	1,15	2,21	3,52	5,20	7,18	9,42	15,08
	$N_{Rk,s,fi(90)}$ [kN]	[kN]	0,79	1,41	2,25	3,33	4,60	6,03	9,65
	$N_{Rk,s,fi(120)}$ [kN]	[kN]	0,61	1,02	1,62	2,39	3,31	4,34	6,94

Tabela C41: Nośność charakterystyczna pod wpływem obciążenia rozciągającego w przypadku zniszczenia przez wyrwanie stożka betonu oraz rozłupanie betonu w warunkach oddziaływania pożaru

Rozmiar łącznika		M8, M10, M12, M16, M20, M24, M27, M30 [cal] 3/8, 1/2, 5/8, 3/4, 7/8, 1, 1 1/4
HAS 5.8, 5.8 HDG HAS 8.8, 8.8 HDG HAS-U 5.8, 5.8 HDG HAS-U 8.8, 8.8 HDG HIT-V 5.8, 5.8F HIT-V 8.8, 8.8F	$N^0_{Rk,c,fi(30)}$ [kN]	$\frac{h_{ef}}{200} \cdot N^0_{Rk,c} \leq N^0_{Rk,c}$
	$N^0_{Rk,c,fi(60)}$ [kN]	
	$N^0_{Rk,c,fi(90)}$ [kN]	
HAS-E-55 HAS-B-105 (HDG) HAS A4 HAS-U A4-70 HAS-U HCR	$N^0_{Rk,c,fi(120)}$ [kN]	$0,8 \cdot \frac{h_{ef}}{200} \cdot N^0_{Rk,c} \leq N^0_{Rk,c}$
	Charakterystyczny rozstaw Scr,N,fi [mm]	$4h_{ef}$
Charakterystyczna odległość od krawędzi Ccr,N,fi [mm]	$2h_{ef}$	

Injection system Hilti HIT-RE 500 V4

Charakterystyki

Nośność charakterystyczna pod wpływem obciążenia rozciągającego w przypadku zniszczenia stali oraz wyłamania stożka betonu w warunkach pożaru

271/273

Załącznik C40

Tabela C42: Nośność charakterystyczna pod wpływem obciążenia ścinającego w przypadku zniszczenia stali w warunkach oddziaływania pożaru

Rozmiar łącznika		M8	M10	M12	M16	M20	M24	M27	M30
HAS 5.8, 5.8 HDG HAS 8.8, 8.8 HDG HAS-U 5.8, 5.8 HDG HAS-U 8.8, 8.8 HDG HIT-V 5.8, 5.8F HIT-V 8.8, 8.8F	$V_{Rk,s,fi(30)}$ [kN]	1,04	1,77	2,76	5,15	8,04	11,58	15,05	18,40
	$V_{Rk,s,fi(60)}$ [kN]	0,81	1,34	2,03	3,79	5,91	8,51	11,07	13,53
	$V_{Rk,s,fi(90)}$ [kN]	0,59	0,91	1,30	2,42	3,78	5,45	7,09	8,66
	$V_{Rk,s,fi(120)}$ [kN]	0,47	0,70	0,94	1,74	2,72	3,92	5,09	6,22
	$M^0_{Rk,s,fi(30)}$ [Nm]	1,06	2,28	4,29	10,92	21,28	36,81	54,58	73,76
	$M^0_{Rk,s,fi(60)}$ [Nm]	0,83	1,73	2,03	3,79	5,91	8,51	11,07	13,53
	$M^0_{Rk,s,fi(90)}$ [Nm]	0,60	1,17	2,02	5,13	10,01	17,32	25,69	34,71
	$M^0_{Rk,s,fi(120)}$ [Nm]	0,48	0,89	1,45	3,69	7,20	12,45	18,46	24,95
HAS A4 HAS-U A4-70 HAS-U HCR	$V_{Rk,s,fi(30)}$ [kN]	2,67	4,85	7,94	14,78	23,06	33,23	43,21	52,81
	$V_{Rk,s,fi(60)}$ [kN]	1,93	3,44	5,57	10,37	16,18	23,32	30,32	37,06
	$V_{Rk,s,fi(90)}$ [kN]	1,18	2,03	3,20	5,96	9,30	13,40	17,43	21,30
	$V_{Rk,s,fi(120)}$ [kN]	0,80	1,33	2,02	3,76	5,86	8,44	10,98	13,42
	$M^0_{Rk,s,fi(30)}$ [Nm]	2,73	6,25	12,33	31,34	61,10	105,67	156,68	211,71
	$M^0_{Rk,s,fi(60)}$ [Nm]	1,97	4,43	8,65	21,99	42,87	74,14	109,93	148,55
	$M^0_{Rk,s,fi(90)}$ [Nm]	1,20	2,62	4,97	12,64	24,64	42,61	63,19	85,38
	$M^0_{Rk,s,fi(120)}$ [Nm]	0,82	1,71	3,13	7,96	26,85	26,85	39,81	53,80

Tabela C43: Nośność charakterystyczna pod wpływem obciążenia ścinającego w przypadku zniszczenia stali w warunkach oddziaływania pożaru

Rozmiar łącznika		[cal]	3/8	1/2	5/8	3/4	7/8	1	1 1/4
HAS-E-55 HAS-B-105 (HDG)	$V_{Rk,s,fi(30)}$ [kN]		1,50	3,00	4,78	7,08	9,77	12,82	20,50
	$V_{Rk,s,fi(60)}$ [kN]		1,15	2,21	3,52	5,20	7,18	9,42	15,08
	$V_{Rk,s,fi(90)}$ [kN]		0,79	1,41	2,25	3,33	4,60	6,03	9,65
	$V_{Rk,s,fi(120)}$ [kN]		0,61	1,02	1,62	2,39	3,31	4,34	6,94
	$M^0_{Rk,s,fi(30)}$ [Nm]		1,96	4,45	9,77	17,59	28,54	42,88	86,77
	$M^0_{Rk,s,fi(60)}$ [Nm]		1,44	3,39	7,18	12,94	20,98	31,53	63,81
	$M^0_{Rk,s,fi(90)}$ [Nm]		0,92	2,34	4,59	8,28	13,43	20,18	40,84
	$M^0_{Rk,s,fi(120)}$ [Nm]		0,66	1,81	3,30	5,95	9,65	14,50	29,35

Injection system Hilti HIT-RE 500 V4

Charakterystyki

Nośność charakterystyczna pod wpływem obciążenia ścinającego w przypadku zniszczenia stali w warunkach pożaru

Załącznik C41

Tabela C44: Nośność charakterystyczna pod wpływem obciążenia ścinającego w przypadku zniszczenia przez wyłupanie betonu w warunkach oddziaływania pożaru

Rozmiar łącznika		M8, M10, M12, M16, M20, M24, M27, M30 [cal] 3/8, 1/2, 5/8, 3/4, 7/8, 1, 1 1/4
HAS 5.8, 5.8 HDG HAS 8.8, 8.8 HDG HAS-U 5.8, 5.8 HDG HAS-U 8.8, 8.8 HDG HIT-V 5.8, 5.8F HIT-V 8.8, 8.8F	$V_{Rk,cp,fi(30)}$ [kN]	$k_8 \cdot N_{Rk,c,fi(90)}$
HAS-E-55 HAS-B-105 (HDG)	$V_{Rk,cp,fi(60)}$ [kN]	
HAS A4 HAS-U A4-70 HAS-U HCR	$V_{Rk,cp,fi(90)}$ [kN]	
	$V_{Rk,cp,fi(120)}$ [kN]	$k_8 \cdot N_{Rk,c,fi(120)}$

Tabela C45: Nośność charakterystyczna pod wpływem obciążenia ścinającego w przypadku zniszczenia krawędzi podłoża betonowego w warunkach oddziaływania pożaru

Rozmiar łącznika		M8, M10, M12, M16, M20, M24, M27, M30 [cal] 3/8, 1/2, 5/8, 3/4, 7/8, 1, 1 1/4
HAS 5.8, 5.8 HDG HAS 8.8, 8.8 HDG HAS-U 5.8, 5.8 HDG HAS-U 8.8, 8.8 HDG HIT-V 5.8, 5.8F HIT-V 8.8, 8.8F	$V_{Rk,c,fi(30)}$ [kN]	$0,25 \cdot V_{Rk,c}^0$
HAS-E-55 HAS-B-105 (HDG)	$V_{Rk,c,fi(60)}$ [kN]	
HAS A4 HAS-U A4-70 HAS-U HCR	$V_{Rk,c,fi(90)}$ [kN]	
	$V_{Rk,c,fi(120)}$ [kN]	$0,20 \cdot V_{Rk,c}^0$

Injection system Hilti HIT-RE 500 V4

Charakterystyki

Nośność charakterystyczna pod wpływem obciążenia ścinającego w przypadku zniszczenia przez wyłupanie betonu oraz zniszczenie krawędzi podłoża betonowego w warunkach pożaru

273/273

Załącznik C42